



**FOCUSED FEASIBILITY STUDY WORK PLAN  
ExxonMobil / ADC Property, Ecology Site ID 2728  
2717/2731 Federal Avenue  
Everett, Washington**

Submitted to:

**ExxonMobil Environmental Services**  
East Providence Terminal  
1001 Wampanoag Trail  
Riverside, Rhode Island 02915

And

**American Distributing Company**  
13618 45th Avenue NE  
Marysville, Washington 98271

Submitted by:

**AMEC Earth & Environmental, Inc.**  
11810 North Creek Parkway North  
Bothell, Washington 98011

February 26, 2010

AMEC Project No. 9-915-15716-C



February 26, 2010  
Project No. 9-915-15716-C

ExxonMobil Environmental Services  
East Providence Terminal  
1001 Wampanoag Trail  
Riverside, Rhode Island 02915

Attention: Mr. Joseph Abel

American Distributing Company  
13618 45th Avenue NE  
Marysville, Washington 98271

Attention: Mr. Miller

**Subject: Focused Feasibility Study Work Plan**  
ExxonMobil / ADC Property, Ecology Site ID 2728  
2717/2731 Federal Avenue, Everett, Washington

AMEC Earth & Environmental, Inc. (AMEC) is pleased to submit this Focused Feasibility Study Work Plan that incorporates a Data Gap Investigation sampling and analysis plan for the above-referenced property located in Everett, Washington.

We appreciate the opportunity to have served you on this project. If you have any questions or desire further information, please feel free to contact us at (425) 368-1000.

Sincerely,

AMEC Earth & Environmental, Inc.

Anastasia Speransky, LHg  
Project Hydrogeologist



Gary Dupuy, LHg  
Principal

AMEC Earth & Environmental, Inc.  
11810 North Creek Parkway North  
Bothell, Washington 98011  
(425) 368-1000 Phone  
(425) 368-1001 Facsimile  
[www.amec.com](http://www.amec.com)

## TABLE OF CONTENTS

	<u>Page</u>
ACRONYMS AND ABBREVIATIONS.....	vi
1.0 INTRODUCTION.....	1
1.1 Purpose of the Work Plan .....	1
1.2 Organization of the Report .....	1
2.0 SITE SETTING AND BACKGROUND .....	3
2.1 Property and Vicinity Description .....	3
2.2 Site Ownership and Operational History .....	3
2.2.1 ExxonMobil/ADC Property .....	4
2.2.2 History of Surrounding Properties.....	5
2.3 Site Regulatory History .....	7
2.4 Environmental Setting .....	8
2.4.1 Topography.....	9
2.4.2 Geology and Hydrogeology .....	9
2.4.3 Surface Water Hydrology.....	9
2.4.4 Meteorology .....	10
2.4.5 Ecological Setting .....	10
2.4.6 Tidal Influence .....	11
2.4.7 Historic and Cultural Resources .....	11
3.0 PREVIOUS SITE INVESTIGATIONS AND INTERIM REMEDIAL ACTIONS.....	13
3.1 Previous Environmental Investigations Conducted at the Site for Soil and Groundwater.....	13
3.2 Interim Remedial Actions .....	17
3.2.1 Infiltration Gallery in Vicinity of MW-14 .....	18
3.2.2 Groundwater Extraction and Treatment.....	18
3.2.3 Recovery Trench In the Vicinity of Side Sewer.....	18
3.2.4 Combined Sewer Overflow Line Repair.....	19
3.2.5 LPH Vacuum Recovery Pilot Test .....	20
3.2.6 Water Management and Treatment System and Asphalt Cap Construction.....	20
3.2.7 LPH Bailing and Groundwater Monitoring .....	22
3.2.8 Puget Sound Outfall 5 Overflow Structure Project.....	22
4.0 ONGOING GROUNDWATER MONITORING/PETROLEUM RECOVERY .....	23
4.1 Petroleum Recovery .....	23
4.2 Monitoring of Groundwater Quality.....	23
5.0 PRELIMINARY SCREENING LEVELS .....	25
5.1 Preliminary Soil Screening Levels .....	25
5.2 Preliminary Groundwater Screening Levels .....	25
6.0 SUMMARY OF CURRENT ENVIRONMENTAL SITE CONDITIONS.....	26
6.1 Soil .....	26

6.1.1	TPH-D, TPH-O, and TPH (undifferentiated)	27
6.1.2	TPH-G	28
6.1.3	Benzene, Toluene, Ethylbenzene, and Total Xylenes	28
6.1.4	Lead	28
6.1.5	PAHs	29
6.2	Liquid-Phase Hydrocarbons	29
6.3	Groundwater	30
6.3.1	TPH-D or TPH (undifferentiated)	30
6.3.2	TPH-G	30
6.3.3	Benzene, Toluene, Ethylbenzene, and Total Xylenes	31
6.3.4	Total and Dissolved Lead	31
6.3.5	PAHs	32
7.0	CONCEPTUAL SITE MODEL AND PATHWAYS	33
7.1	Current and Future Land/Water Uses	33
7.2	Sources and Types of Contamination	34
7.3	Contaminant Migration Pathways/Media of Potential Concern	36
7.3.1	Soil	36
7.3.2	Groundwater	36
7.3.3	Vapor	36
7.3.4	Stormwater	37
7.3.5	Surface Water	37
7.3.6	Sediment	37
7.4	Indicator Hazardous Substances	37
7.4.1	Soil	38
7.4.2	Groundwater	39
7.5	Potential Receptors and Exposure Pathways	41
7.5.1	Potential Receptors	41
7.5.2	Potential Exposure Pathways	41
7.6	Overview of Site Conditions	42
8.0	FOCUSED FEASIBILITY STUDY	44
8.1	Data Gaps and Supplemental Field Investigations	44
8.1.1	Extent of TPH-D, TPH-O, and TPH-G Impacts in Groundwater	44
8.1.2	Nature of Aquitard Below Property	45
8.1.3	Extent of Soil Impacts Surrounding ADC Parcel	45
8.1.4	Tidal Influences	45
8.1.5	Extent of Ongoing Natural Attenuation	46
8.1.6	Aquifer Properties	46
8.1.7	Analytical Testing	46
8.2	General Approach to Focused Feasibility Study	47
8.2.1	Review of Potential Remedial Alternatives	48
8.2.2	Contents of FFS	50
9.0	REFERENCES	53

## LIST OF TABLES

Table 1	Chronology of Historical On-Site Environmental Investigations and Remedial Actions
Table 2	Analytical Results for Total Petroleum Hydrocarbons in Soil
Table 3	Analytical Results for TPH as Gasoline, Benzene, Toluene, Ethylbenzene, Total Xylenes, and Lead in Soil
Table 4	Analytical Results for Polycyclic Aromatic Hydrocarbons in Soil
Table 5	Analytical Results for Total Petroleum Hydrocarbons in Groundwater
Table 6	Analytical Results for TPH as Gasoline, Benzene, Toluene, Ethylbenzene, Total Xylenes, and Lead in Groundwater
Table 7	Analytical Results for Polycyclic Aromatic Hydrocarbons in Groundwater
Table 8	Statistical Summary of Soil Analytical Results
Table 9	Statistical Summary of Groundwater Analytical Results

## LIST OF FIGURES

Figure 1	Site Location Map
Figure 2	Plan of the Property and Vicinity
Figure 3	1930 Great Northern Railway Everett Map
Figure 4	Features Seen in 1930 Great Northern Railway Everett Map over 2003 Aerial
Figure 5	Aerial 1947
Figure 6	Features Seen in 1947 Aerial over 2003 Aerial
Figure 7	Aerial 1955
Figure 8	Features Seen in 1955 Aerial over 2003 Aerial
Figure 9	Aerial 1967
Figure 10	Features Seen in 1967 Aerial over 2003 Aerial
Figure 11	Aerial 1976
Figure 12	Features Seen in 1976 Aerial over 2003 Aerial
Figure 13	Aerial 1993
Figure 14	Features Seen in 1993 Aerial over 2003 Aerial
Figure 15	Historical Explorations and Locations of Geologic Cross Sections A–A', B–B', and C–C'
Figure 16	Geologic Cross-Section A–A'
Figure 17	Geologic Cross-Section B–B'
Figure 18	Geologic Cross-Section C–C'
Figure 19	February 2009 Groundwater Elevation and Flow Direction
Figure 20	Average LPH Thickness from September 2008 to February 2009
Figure 21	Groundwater Sample Analytical Results – August 2008 and February 2009
Figure 22	Horizontal Distribution of TPH-Diesel, TPH-Oil, and Undifferentiated TPH in Soil
Figure 23	Vertical Distribution of TPH-D or TPH (Undifferentiated) in Soil: Cross Section A–A'

Figure 24	Vertical Distribution of TPH-D or TPH (Undifferentiated) in Soil: Cross Section B–B'
Figure 25	Vertical Distribution of TPH-D or TPH (Undifferentiated) in Soil: Cross Section C–C'
Figure 26	Horizontal Distribution of TPH-Gasoline in Soil
Figure 27	Vertical Distribution of TPH-G in Soil: Cross Section A–A'
Figure 28	Vertical Distribution of TPH-G in Soil: Cross Section B–B'
Figure 29	Vertical Distribution of TPH-G in Soil: Cross Section C–C'
Figure 30	Horizontal Distribution of Benzene in Soil
Figure 31	Vertical Distribution of Benzene in Soil: Cross Section A–A'
Figure 32	Vertical Distribution of Benzene in Soil: Cross Section B–B'
Figure 33	Vertical Distribution of Benzene in Soil: Cross Section C–C'
Figure 34	Horizontal Distribution of Toluene in Soil
Figure 35	Horizontal Distribution of Ethylbenzene in Soil
Figure 36	Horizontal Distribution of Total Xylenes in Soil
Figure 37	Horizontal Distribution of Lead in Soil
Figure 38	Vertical Distribution of Lead in Soil: Cross Section A–A'
Figure 39	Vertical Distribution of Lead in Soil: Cross Section B–B'
Figure 40	Vertical Distribution of Lead in Soil: Cross Section C–C'
Figure 41	Horizontal Distribution of Adjusted Total cPAHs Concentration in Soil
Figure 42	Vertical Distribution of Toxicity-Adjusted Total cPAHs Concentrations in Soil: Cross Section A–A'
Figure 43	Liquid-Phase Petroleum Hydrocarbon Maximum Thickness Since 2002
Figure 44	Historical Distribution of TPH-D, TPH-O, and TPH in Groundwater, Maximum Detected Value
Figure 45	Historical Distribution of TPH-G in Groundwater, Maximum Detected Value
Figure 46	Historical Distribution of Benzene in Groundwater, Maximum Detected Value
Figure 47	Historical Distribution of Toluene in Groundwater, Maximum Detected Value
Figure 48	Historical Distribution of Ethylbenzene in Groundwater, Maximum Detected Value
Figure 49	Historical Distribution of Total Xylene in Groundwater, Maximum Detected Value
Figure 50	Historical Distribution of Total Lead in Groundwater, Maximum Detected Value
Figure 51	Historical Distribution of Dissolved Lead in Groundwater, Maximum Detected Value
Figure 52	Historical Distribution of Toxicity Equivalency Adjusted Total cPAHs in Groundwater, Maximum Detected Value
Figure 53	Historical Excavation Locations
Figure 54	Area of Impact and Secondary Source Areas
Figure 55	Proposed Data Gap Investigations Exploration Plan

## LIST OF APPENDICES

Appendix A	Sampling and Analysis Plan
Appendix B	Historical Maps and Documentation
Appendix C	Boring Logs, Monitoring Well Logs, and Test Pit Logs
Appendix D	PEG Report (Kimberly-Clark Investigations)
Appendix E	Addendum Sampling and Analysis Plan
Appendix F	Simplified Terrestrial Ecological Evaluation
Appendix G	Schedule
Appendix H	List of applicable or relevant and appropriate requirements

**ACRONYMS AND ABBREVIATIONS**

ADC	American Distributing Company
ADC Parcel	northern parcel
AGRA	AGRA Earth & Environmental, Inc.
AMEC	AMEC Earth & Environmental, Inc.
ASTs	aboveground storage tanks
bgs	below ground surface
BNSF	Burlington Northern Santa Fe Railway
BTEX	benzene, toluene, ethylbenzene, and xylenes
CAP	cleanup action plan
Chevron	Chevron Corporation
cPAHs	carcinogenic PAHs
CSM	conceptual site model
CSO	combined sewer overflow
CSTO	California Street Overcrossing
DAHP	Washington State Department of Archaeology and Historic Preservation
DO	dissolved oxygen
Ecology	Washington State Department of Ecology
EPA	U.S. Environmental Protection Agency
EPH	extractable petroleum hydrocarbons
ERI	Environmental Resolutions, Inc.
ESA	Endangered Species Act
ESE	Environmental Science and Engineering, Inc.
ExxonMobil	ExxonMobil Oil Corporation
ExxonMobil Parcel	southern parcel
°F	degrees Fahrenheit
FFS	Focused Feasibility Study
General Petroleum	General Petroleum of California
gpm	gallons per minute
GPR	ground penetrating radar
HSA	hollow stem auger
IHSs	indicator hazardous substances
KC	Kimberly-Clark
Kleinfelder	Kleinfelder, Inc.
LPH	liquid-phase petroleum hydrocarbons
µg/L	micrograms per liter
mg/kg	milligram per kilograms
MNA	monitored natural attenuation
Mobil	Mobil Oil Corporation
MSL	mean sea level
MTBE	methyl tertiary-butyl ether
MTCA	Model Toxics Control Act
NWTPH-Dx	Northwest Total Petroleum Hydrocarbons–Diesel extended
NWTPH-Gx	Northwest Total Petroleum Hydrocarbons–Gasoline extended



Order	Agreed Order
PAHs	polycyclic aromatic hydrocarbons
PCS	petroleum-contaminated soil
PEG	Pacific Environmental Group, Inc.
PSO	Puget Sound Outfall
P&T	groundwater pump-and-treat
PTI	PTI Environmental Services
PVC	polyvinyl chloride
Premier	Premier Environmental Services, LLC
Property	ExxonMobil/ADC Property
QA	quality assurance
RAOs	remedial action objectives
RZA	Rittenhouse-Zeman & Associates, Inc.
SAP	Sampling and Analysis Plan
Scott	Scott Paper Company
Standard	Standard Oil Company of California
SVE	soil vapor extraction
SVOCs	semivolatile organic compounds
TEQs	toxicity equivalent quotients
Texaco	Texaco Refining and Marketing, Inc.
TPH	total petroleum hydrocarbons
TPH-D	total petroleum hydrocarbons–diesel
TPH-O	total petroleum hydrocarbons–oil
TPH-G	total petroleum hydrocarbons–gasoline
USCG	U.S. Coast Guard
VPH	volatile petroleum hydrocarbons
WAC	Washington Administrative Code
WP	Work Plan
WRCC	Western Regional Climate Center

## **1.0 INTRODUCTION**

AMEC Earth & Environmental, Inc. (AMEC), has prepared this Focused Feasibility Study (FFS) Work Plan (WP) on behalf of ExxonMobil Oil Corporation (ExxonMobil) and the American Distributing Company (ADC) for the ExxonMobil/ADC Property (the Property) located at 2717 and 2731 Federal Avenue in Everett, Washington. AMEC prepared this document to provide background for preparing the FFS and to describe the rationale for additional soil and groundwater investigations at the Property and its vicinity. A Sampling and Analysis Plan (SAP), included as Appendix A to this Work Plan, addresses the specific field sampling activities, chemical analyses, and quality assurance (QA) procedures that will be conducted during additional investigations at the Property. This work plan is based on the Washington State Department of Ecology (Ecology) Model Toxics Control Act (MTCA) Cleanup Regulations, Washington Administrative Code (WAC) 173-340.

### **1.1 Purpose of the Work Plan**

The purposes of this Work Plan are to:

- Present the history of past ownership and operations of the Property and its surroundings (Site);
- Summarize past investigation and interim remedial activities;
- Present the Conceptual Site Model (CSM); and
- Identify any remaining data gaps to complete the FFS.

### **1.2 Organization of the Report**

This FFS WP is organized as follows.

- Section 1** Purpose and Organization of the FFS WP.
- Section 2** Regulatory background and physical setting.
- Section 3** Summary of previous investigations and interim remedial actions.
- Section 4** Description of ongoing groundwater monitoring program.
- Section 5** Discussion of preliminary screening levels.
- Section 6** Summary of environmental conditions at the Site.

- Section 7** Conceptual Site Model and evaluation of potential receptors and exposure pathways.
- Section 8** Approach to conducting the focused feasibility study, including proposed supplemental investigations for addressing data gaps and a preliminary review of potential remedial technologies.
- Section 9** List of references cited in the text.

## 2.0 SITE SETTING AND BACKGROUND

This section summarizes the ownership and history of the Property and surrounding area, regulatory and compliance history, and environmental setting.

### 2.1 Property and Vicinity Description

The Property is located east of Federal Avenue and between California Street and Everett Avenue in the northwest portion of Everett, in Snohomish County, Washington (Figure 1). The Property consists of two parcels that occupy 0.86 acres of land (Figure 2). According to the Snohomish County Tax Assessor records, the southern parcel (the ExxonMobil Parcel) is located at 2731 Federal Avenue, is owned by the Mobil Oil Corporation of Houston, Texas, and occupies approximately one-third of the Property. The northern parcel (the ADC Parcel) is located at 2717 Federal Avenue. The ADC Parcel is owned by the Estate of Mr. Miller of Everett, Washington, and occupies approximately two-thirds of the Property. Currently, no structures or aboveground or underground storage tanks are present on either parcel. The Property is asphalt-paved and currently leased for parking by the adjacent Kimberly-Clark Corporation (KC) facility. A garage that was leased by ADC from approximately the 1930s and later by ADC and General Petroleum Corporation until early 1970s was formerly located to the west of the Property, across Federal Avenue. The layout of the Property and immediate vicinity are shown on Figure 2.

The KC property is located immediately north of the ADC Parcel, at 2600 Federal Avenue. The KC property includes a manufacturing plant for paper products and a warehouse. Presently, Terminal Avenue overcrosses the Burlington Northern Santa Fe Railway (BNSF) line, which is located to the east and south of the Property. Glacier Cold Storage is located beyond Terminal Avenue and the BNSF railway corridor. The properties to the east are currently occupied by BNSF. The properties to the west, beyond Federal Avenue, are occupied by the Port of Everett and Dunlap Towing. The shoreline of Port Gardner Bay is situated approximately 300 feet to the west.

In this document “the Property” will refer to the two contiguous parcels owned by ExxonMobil and by ADC. The Property and portions of neighboring parcels where releases of hydrocarbon contamination on the Property may have migrated comprise the ExxonMobil/ADC Site (Ecology Facility ID 2728), as defined by MTCA (hereafter referred to as “the Site”). The precise boundaries of the Site (i.e., the extent of soil and groundwater contamination resulting from the historic operations on the Property) have not yet been determined. Locations within the Property boundary may be referenced as the Property or on-Property, and locations outside the Property boundaries may be referenced as off-Property.

### 2.2 Site Ownership and Operational History

Historical maps and documentation for the Property and surrounding parcels are compiled in Appendix B. Figures 3 through 14 shows the history of the Property and its surroundings by

superimposing features visible on historical maps and aerial and historical aerial photographs over a contemporary aerial photograph from 2003.

ExxonMobil was formed in 1999 by the merger of Exxon and Mobil Oil Corporation. The Mobil Oil Corporation (Mobil) was the successor to Socony-Mobil Oil Company, Inc., a New York corporation, which merged in or about 1959 with General Petroleum of California (General Petroleum).

From at least the 1920s, the Property was used for petroleum bulk storage, transfer, and distribution operations; marine offloading; truck loading; and rail loading and/or unloading operations of petroleum products that included fuel oils, stove oil, Bunker C, diesel, gasoline, and a blend of synthetic and petroleum base fluids specially designed for compressor applications PS300. (AGRA 1996a). However, only small quantities (55-gallon drum or smaller) of PS300 likely were used/stored at the Property.

### ***2.2.1 ExxonMobil/ADC Property***

According to the 1902 Sanborn Fire Insurance map, the Property was occupied at that time by wooden residential dwellings that lined the historic shoreline of Port Gardner Bay. The Property is labeled “marsh” on the 1902 Sanborn map. By 1914, the entire Property became vacant as shown on the 1914 Sanborn map. In 1915, the City of Everett passed Ordinance No. 1674 granting the Standard Oil Company of California (Standard; now known as Chevron) permission to construct a tank farm consisting of three aboveground storage tanks (ASTs) on Lot 1 of Block 619 (the northern portion of the ADC Parcel [Appendix B]), with piping leading to Standard’s dock on the waterfront. However, it is not certain that the tank farm was actually built. According to the Everett Plant Yard and Tank Elevations Plot Plan, dated April 8, 1946, a portion of the Property was covered by a garbage dump in 1917 (Appendix B). A search for records regarding the dump was conducted at the Washington State Department of Archaeology and Historic Preservation (DAHP) in Olympia and at the Everett Public Library's Northwest History Room. No information was found about the dump existing at the Property and vicinity. Additionally, no evidence was found of previously recorded archaeological sites and/or historic buildings located on this parcel. To date, no Traditional Cultural Properties have been identified (i.e., on record with DAHP) within the project area. Based on historical research, it appears the Property was never used as a formal dump/sanitary landfill that accepted refuse from a city agency or wider geography.

In 1922, Gilmore Oil Co. Ltd. (predecessor to General Petroleum) first leased the Property from the Great Northern Railway of Minnesota (a predecessor to BNSF) for petroleum bulk storage, transfer, and distribution operations; marine offloading; truck loading; and rail loading and/or unloading operations (Appendix B). In 1927, Gilmore Oil Co. Ltd. became an owner of the Property (Appendix B) and General Petroleum and successors to the property, which included Mobil and ADC, continued bulk plant operations. In 1974, Mobil sold the northern two-thirds of the Property (the current ADC Parcel) to Mr. A. P. Miller for use by ADC and continued to operate a small bulk plant on the southern one-third of the Property (the ExxonMobil Parcel) until 1987. ADC continued to operate a terminal until 1990.

In 1985, the recorded on-Property structures on the ExxonMobil Parcel included two warehouse buildings, a pumphouse, and two diked fuel storage areas, each of which included two 25,000-gallon ASTs. Each pair of tanks was completely enclosed by a concrete dike ranging in height from approximately 4 to 12 feet. According to Rittenhouse-Zeman & Associates, Inc. (RZA) (RZA 1985), evidence of surface spillage on the ExxonMobil Parcel was apparent at several areas, including the unloading racks, pumphouse, and near the outdoor drum storage area. RZA (1985) reported that a number of unintentional releases of petroleum products had occurred in the past due to tank leakage, tank overfills, and surface spills associated with the four ASTs. In addition, fuel storage tanks were present prior to the RZA study in the northwest corner of the ExxonMobil Parcel. The structures on the ExxonMobil Parcel were demolished in approximately 1987.

By 1990, four large ASTs with capacities ranging from 5,037 to 9,345 barrels and five small ASTs with capacities ranging from 135 to 714 barrels, surrounded by a 13-foot-high concrete firewall, occupied the northern half of the ADC Parcel. An office building, a warehouse, a boiler room, an oil pump house, loading racks, and overhang canopies were located within the southern portion of the ADC Parcel. In addition, a 1,000-gallon AST, aboveground piping, and a concrete wall were located within the southern portion of the ADC Parcel. All structures on the ADC Parcel were demolished in 1998.

In 1999 the Property, to meet the requirements of the 1998 Agreed Order (DE-98TCP-N223), was asphalt-capped for intermittent use as a parking lot by neighboring businesses.

### ***2.2.2 History of Surrounding Properties***

Several other facilities located to the north and northeast of the Property historically operated as petroleum bulk facilities and included fuel pipelines, pumping facilities, storage facilities, railroad spurs, and railroad and maritime loading facilities. AGRA Earth and Environmental, Inc. (AGRA), identified various corporations that had operations that could have resulted in releases of contaminants in the vicinity of the Property. These corporations included BNSF Company, Chevron Corporation (Chevron), KC, Scott Paper Company (Scott), and Texaco Refining and Marketing, Inc. (Texaco).

Historical features and operations of properties that surround the Property to the north, south, east, and west are shown on Figures 3 through 14. A brief summary of operations and activities at the properties is presented below.

#### **North, Northeast, and Northwest**

In 1930, the area to the north and northeast of the Property (currently occupied by KC) was occupied by Associated Oil Company (predecessor to Texaco) and Standard, based on the 1930 Great Northern Railway real estate map and Sanborn maps. Two railroad spurs labeled "Associated Oil Co." and "General Petroleum Corp" are located to the east of the Property and extend north. Three small oil ASTs were located at that time at the eastern boundary of the Standard property adjacent to a railroad spur labeled "Standard Oil Co." (Figures 3 and 4).

In 1947, four small and two large ASTs were located on the Associated Oil Company property to the north of the ADC Parcel, and three small Standard Oil ASTs remained next to the railroad spur (Figures 5 and 6).

According to a 1955 aerial photograph (Figure 7), four small ASTs were installed half-way between the Associated Oil Company tank farm and the General Petroleum tank farm (Figure 8). Standard issued a quit claim for the Standard parcel to Scott Paper Company in 1958. In 1963, Standard Oil sold its remaining property to Scott.

According to a 1967 aerial photograph (Figure 9), the number of ASTs present on the Associated Oil property expanded from six to eight (as compared to the 1955 aerial photograph) with the addition of two large fuel oil ASTs. The four small fuel oil ASTs located just south of Associated Oil's fuel farm were also present on the 1967 aerial photograph. By that time, KC's T-shaped warehouse was built over three different former Standard ASTs (Figure 10).

The five ASTs located on the Associated Oil Company fuel farm were still visible in the 1976 aerial photograph (Figures 11 and 12). In addition, two large ASTs located northeast of Associated's fuel farm and north of the KC warehouse appear on the 1976 aerial photograph. The ownership of these two ASTs is not clear, however, according to the Polk City directories Scott Paper Co. was listed as occupying at the area to the north from 1958 to 1995. KC was listed as the owner of this property from 1995 until present.

Two of the Associated Oil Company ASTs remain visible in the 1993 aerial photograph (Figures 13 and 14). The two ASTs north of the KC warehouse are also visible in the 1993 photograph. In 1995, KC purchased the Scott property. A reconnaissance of the Property and vicinity conducted by AGRA in 1996 (AGRA, 1996a) indicated that one of the larger ASTs in the former Standard fuel farm was labeled as containing #3 Fuel Oil, and one of the smaller ASTs was labeled "caustic". The contents of the ASTs north of the KC warehouse are unknown (AGRA, 1996a).

## **South**

In the late 1980s to early 1990s, Mr. Jack Johnston (part-owner of Johnston Petroleum) purchased the adjacent property south of the ExxonMobil Parcel from BNSF. The Johnston property has been used for parking vehicles, storing packaged goods and oils, and receiving containers (e.g. drums) to be shipped to a recycling facility. In 2001, the California Street Overcrossing ramp was constructed covering the Johnston Estate Parcel and the southeast corner of the ExxonMobil Parcel. The former Johnston property is depicted on Figure 14.

## **West**

According to the 1930 Great Northern Railway real estate map, Sanborn maps and a lease document, ADC leased from Great Northern Railway the building located to the west of Federal Avenue and between 26th Street and California Street (Figures 3 to 10). The lease commenced in 1937 and extended till 1971. General Petroleum (predecessor of ExxonMobil) sub-leased the building from ADC between 1951 and 1971. General Petroleum and ADC stored oil and grease and trucks in the warehouse and oil in steel drums adjacent to the warehouse. A wash rack and

boiler room was located in the southern end of the building in 1957 (1957 Sanborn map). According to aerial photographs, the warehouse was removed sometime prior to 1976. In addition, a fuel pier that was adjacent to the warehouse and extended westward into Port Gardner Bay was leased by ADC and sub-leased to General Petroleum. In 1973 the western shoreline was infilled to its current configuration by the Port of Everett. The Port of Everett currently owns the properties to the west of the Property. The Port of Everett uses these properties as a storage yard.

## East

According to the 1930 Great Northern Railway real estate map and Sanborn maps, the property to the east has belonged to Burlington Northern (later known as BNSF) since 1930.

Photographs and building plans showed a spur to the east of the Property that with a petroleum-loading rack used to pump oil into railroad tank cars. In a 1947 photograph, the area appears to be unpaved with low-lying vegetation. The area appears to be predominantly used as an open parking lot during 1955, 1967, 1985, 1993, and 2003 (photograph). According to the City of Everett Tax Assessor records, the property to the east belongs to BNSF and is used as an open parking lot for KC workers. The City of Everett right-of-way alley separates the Property from the BNSF parcel.

## 2.3 Site Regulatory History

Petroleum contamination has been found in soil and groundwater beneath the Property and beneath properties to the west (Port of Everett), north (Everett Avenue right-of-way and adjacent to the KC warehouse), and east (BNSF property and in the vicinity of the former loading racks).

In October 1995, free-phase petroleum liquid characterized as biodegraded heavy fuel oil fractions was observed to have seeped through the City of Everett's combined sewer overflow (CSO) line in Port Gardner Bay. The United States Coast Guard (USCG) performed multiple phases of petroleum hydrocarbon fingerprinting/typing analysis of the liquid-phase petroleum hydrocarbons (LPH) discharging into Port Gardner Bay from samples collected at the CSO and surrounding wells (Appendix B). Typing analysis of the LPH indicated that the petroleum hydrocarbons in Port Gardner Bay had characteristics similar to several petroleum products, including No. 2 fuel, heavy fuel oil (Bunker C), and weathered crude oil. The results of the fingerprinting indicated that there were likely multiple sources that contributed to the spill observed emerging from the CSO (*i.e.*, some samples from the Bay were similar to petroleum hydrocarbons from the Property but many were not). Fingerprinting of petroleum hydrocarbon from the Property in 1995 and 2006 identified a range of products including degraded diesel mixed with degraded gasoline and heating oil. Samples from the eastern part of the Property collected in 1995 had characteristics of heavy oil similar to Bunker C or crude oil.

There is no history of crude oil storage on the Property as the facility was used for finished product distribution.



In 1995, Mobil and ADC entered into an Agreed Order (Order) (DE-95TC-N402) with Ecology to take necessary steps to clean up, eliminate, and/or contain petroleum releases at and near the City of Everett CSO discharge line and/or diffuser into Port Gardner Bay. The 1995 Order also required pilot testing of petroleum recovery technologies; characterization of the nature of contamination in the vicinity of the CSO line; and repair of the CSO line. Interim remedial actions were undertaken and studies performed at the Site demonstrated that the pathway to the Bay had been removed. Approximately 23,000 gallons of petroleum were recovered within the vicinity of the CSO line by various interim remedial measures. In December 1996, Ecology issued notice of potential liability letters to Kimberly-Clark, Texaco, BNSF, Scott Paper, and Chevron which stated that there was credible evidence of releases of hazardous substances from the properties owned or operated by each of these companies.

In 1998, Mobil and ADC entered into a new Agreed Order (DE-98TCP-N223) with Ecology to complete a remedial investigation/FFS. Remedial action objectives (RAOs) were developed and approved by Ecology using existing analytical data, agreed-upon exposure pathway analyses, and a screening-level risk assessment. The cleanup approach selected to achieve RAOs included an LPH interceptor trench along the western and northern boundaries of the Property and a low-permeability cap over the Property. The interceptor trench and cap were installed in 1999.

Periodic groundwater monitoring began at the Site in the early 1990s. Regular quarterly groundwater monitoring and monthly LPH gauging and removal commenced in 2002, as a continued requirement under the 1998 Agreed order and in accordance with a monitoring program specified by Premier Environmental Services, LLC (Premier) (Premier 2002) and submitted to Ecology.

In 2007, the groundwater monitoring frequency for the Site was reduced from quarterly to semiannually. This change in monitoring frequency was verbally accepted by Ecology in February 2007 and followed up with a letter on May 8, 2007. The acceptance was again confirmed in a meeting with Ecology on August 8, 2007.

In 2009, a third Agreed Order between Ecology, ExxonMobil, and ADC was negotiated for the Site. The draft Agreed Order to be issued for public comment specifies that an FFS and Draft Cleanup Action Plan (CAP) be prepared to identify the nature and extent of site soil and groundwater contamination and a preferred final cleanup action to address contamination in soil and groundwater at the ExxonMobil/ADC Site in compliance with requirements under MTCA.

## **2.4 Environmental Setting**

This section presents a summary of general environmental conditions at the Property and immediate vicinity. The Property is located in the southwest quarter of Section 19, Township 29 North, Range 5 East, Willamette Meridian. The nearest surface water is Port Gardner Bay of Possession Sound, located approximately 300 feet west of the Property.

### **2.4.1 Topography**

The topography of the Property and immediate vicinity is relatively flat with an elevation of approximately 11 feet above mean sea level (MSL). The area slopes gently to the west toward Port Gardner Bay. Higher elevations, up to 150 feet above MSL, exist to the east of the Property. The surrounding area consists of roadways, industrial buildings surrounded by parking lots, and a storage area.

### **2.4.2 Geology and Hydrogeology**

Soil boring, monitoring well, and test pit logs are compiled in Appendix C. The stratigraphy underlying the Site is displayed on geologic cross-sections A-A', B-B', and C-C', which are presented on Figures 16 through 18, respectively. The locations of the cross-sections are shown on Figure 15.

The area surrounding the Property is underlain by Vashon advance outwash deposits (Qva) and Transitional beds (Qtb). The outwash deposits are primarily granular, and the Transitional beds are composed of interbedded clayey, silty fine to medium sand. Based on subsurface investigations conducted at the Property and surrounding vicinity, the area is underlain by a heterogeneous mixture of fill materials consisting of very loose to medium dense brown, brownish gray, and gray silty sand and sand with areas of wood and brick debris extending to depths of approximately 5 to 10 feet below ground surface (bgs).

Previously, the materials encountered beneath the shallow fill were interpreted as additional fill materials extending to approximate depths of 20 to 27 feet bgs. The deeper materials were reported to be consistent in color (gray) and were characterized as silty sand and silt and dark-brown to black peat mixed with wood debris. However, based on review of previous investigations conducted during preparation of this FFS WP, the grey silty sand/silt unit with peat mixed with wood debris can be interpreted as native marsh deposits. Materials that occur beneath the Property at depths greater than 20 to 27 feet bgs consist of dense, moist, brown, medium sand with various amounts of silt and discontinuous stiff, brown, organic-rich, clayey silt with some fine sand. The deeper materials were interpreted to be Quaternary-aged transitional beds, deposited between Fraser and pre-Fraser glaciations.

Due to the proximity of the Site to Port Gardner Bay, shallow unconfined groundwater occurs at the Site and surroundings at depths of 1 to 5 feet bgs. Previous groundwater elevation data indicate fluctuations between high and low seasonal water tables of up to 3 feet. Based on the historical groundwater elevation data, groundwater beneath the Property flows generally to the west and to the northwest (Figure 19).

### **2.4.3 Surface Water Hydrology**

Surface water at the Property flows to the west and northwest, following the surface slope, toward seven catch basins on the Property. The catch basins are located in two linear groups, which are oriented north-south (Figure 2). Catch basins CB05, CB03, CB04, and CB06 (listed south to north) are approximately 70 feet east of the western boundary of the Property. Catch basins CB07, CB01, and CB02 (listed south to north) are approximately 15 feet east of the

western boundary of the Property. The area is served by a combined (storm and sanitary) sewer. Sewage is pumped to and treated at the City of Everett sewage treatment plant. The storm sewer system at the Property is shown on Figure 2.

#### **2.4.4 Meteorology**

Everett has a moderate climate usually classified as Marine west coast, typified by wet, cool winters and relative dry, warm summers. Temperature extremes are moderated by the proximity to the adjacent Puget Sound and the greater Pacific Ocean. The region lies in a partial rain shadow, partially protected from Pacific storms by the Olympic Mountains, and from Arctic air by the Cascade Range.

The Western Regional Climate Center (WRCC) provides a summary of Climatological statistics for Everett Junior College (located approximately 2 miles from the Property) (WRCC 2009). The average annual temperature measured at Everett Junior College is 50.6 degrees Fahrenheit (°F). Average monthly temperature varies from about 39°F in January to about 63°F in July and August. Winters are cool and wet with average lows around 35°F on winter nights. Colder weather can occur, but seldom lasts more than a few days. Summers are dry and warm, with average daytime highs around 73°F. Hotter weather usually occurs only during a few summer days. The hottest official recorded temperature was 98°F on June 6, 1955; the coldest recorded temperature was 0°F on November 11, 1993 (WRCC 2009).

Total annual precipitation is about 35.5 inches, with about two-thirds of the rainfall occurring during the wet season from October through March. Monthly average rainfall varies from a maximum of 5.02 inches in December to 1.03 inch in July. Most of the precipitation falls as drizzle or light rain, with only occasional downpours (WRCC 2009). The 10-year and 100-year recurrence interval, 24-hour precipitation events are approximately 2.25 inches and 3.25 inches, respectively (Miller et al. 1973).

#### **2.4.5 Ecological Setting**

The Property is located near the marine shoreline in the Snohomish River basin (Water Resource Inventory Area 7), in an area zoned for heavy industrial development. The Everett Naval Station is located to the north and northeast of the Site. No wetlands, streams, shorelines, floodplains, or functional wildlife habitat occur on the Property. Nearby environmentally sensitive areas include Port Gardner and the Snohomish River.

Port Gardner is located 300 feet west of the Property and contains the nearest wildlife area. The portion of Port Gardner shoreline located near the ExxonMobil/ADC Site is classified as Dungeness crab (*Cancer magister*) habitat, according to the City of Everett Fish and Wildlife Habitat Conservation Areas Critical Areas Map (City of Everett, 2006).

Species listed under the Endangered Species Act (ESA) and Washington State Priority Species may be present in Port Gardner. ESA-listed species present in Port Gardner may include Chinook salmon (*Oncorhynchus tshawytscha*), bull trout (*Salvelinus confluentus*), coho salmon (*O. kisutch*), and steelhead (*O. mykiss*). Adult salmonid use of the area is limited to migration

and possibly physiological transition. Juvenile use of the area is similar, but may also include feeding/rearing and refuge from predation (City of Everett 2002).

Common invertebrates present in Port Gardner include snails (*Littorina spp.*), mussels (*Mytilus cf. edulis*), clams (*Macoma balthica*, *Macoma spp.*, *Cryptomya spp.*), cockles (*Clinocardium sp.*), jingle shells (*Pododesmus macroschisma*), polychaetes (*Nereis spp.*, *Notomastus spp.*, *Nephtys spp.*, *Glycera spp.*), barnacles (*Balanus glandula*), shore crabs (*Hemigrapsus spp.*), isopods (*Gnorimosphaeroma oregonesis*), ghost shrimp (*Callinassa sp.*), blue mud shrimp (*Upogebia pugettensis*), Dungeness crab (*Cancer magister*), red crab (*C. productus*), and anemones (*Mertridium senile*) (City of Everett 2002).

Water quality in Port Gardner meets Washington State requirements for all parameters and is not listed on the Ecology's 303d list.

The Snohomish River is situated east and north of the ExxonMobil/ADC Property, approximately 1.5 miles away at the closest point. The River is separated from the Property by areas of industrial and other development, including the City of Everett's Central Business District, residential and commercial development, and areas of industrial and maritime services along the Snohomish River shoreline.

As mentioned previously, no wetlands, streams, shorelines, floodplains, or functional wildlife habitat occur on the Property or within the immediate vicinity (NWI 2009; City of Everett 2006, 2009). Vegetation in the vicinity of the Property is sparse and generally limited to maintained landscaping, including ornamental shrubs and trees. The nearest stream habitat is Pigeon Creek #1 and its associated wetlands, located approximately 1 mile southwest of the Property.

#### **2.4.6 Tidal Influence**

Tidal studies were conducted at the Property by RZA AGRA in 1991 and AMEC in 2008. As reported by Exponent (1998a), AGRA monitored water levels in selected monitoring wells for a 48-hour period to measure the recovery after the 24-hour aquifer test and to assess potential tidal influences in shallow groundwater. During the 48-hour period, no clear evidence of tidal fluctuations was noted. Based on the results of the recovery monitoring, the observed hydraulic gradient at the Property, and the distance from Port Gardner Bay, it was concluded that tidal influences on shallow groundwater at the Property would be expected to be negligible (Exponent, 1998a).

No determinations were made based on AMEC's (2008b) tidal study results, and further tidal influence studies will be conducted (see Section 8.1.4).

#### **2.4.7 Historic and Cultural Resources**

Records were researched at the DAHP in Olympia and at the Everett Public Library's Northwest History Room. No information regarding historic and cultural resources was found for the Property. Additionally, there are no previously recorded archaeological sites and/or historic buildings located on the Property. Although no specific Traditional Cultural Properties have been identified within the project area, the Everett waterfront in general has a long history of tribal

use. A brief summary of tribal use associated with the Everett waterfront along with tribal engagement activities that have taken place for the project was provided by Ecology and is set forth below.

Ecology is working with landowners/stakeholders including local Indian tribes to cleanup contaminated sites and sediments in the vicinity of Port Gardner Bay area and the Snohomish River Estuary. Port Gardner Bay is identified as a high-priority, "early-action" cleanup area under the Puget Sound Initiative (PSI). The ExxonMobil/ADC Site has been identified as a cleanup site under the PSI. Local tribes that have been actively engaged by Ecology under the PSI at Port Gardner include the Tulalip, Suquamish, Swinomish, and Lummi. Ecology has worked with a tribal liaison to assist in developing contacts and early engagement with cultural and natural resource sections within each of the aforementioned tribes. Engagement with the tribes has consisted of meetings to discuss PSI cleanup sites and cultural resources, providing the tribes with draft work products for early input, and providing them with a monthly update containing the current status of each PSI site, near term work products for tribal review, project schedules, and a summary of tribal engagement for the Port Gardner Puget Sound Initiative Sites.

Based on Ecology's discussion with the tribes and information provided in a 1973 *Historical Survey of Everett* (Dilgard and Riddle, 1973), people have inhabited the Port Gardner Bay area for thousands of years. For centuries, the northwest point of the peninsula (i.e., Preston Point) was the site of Hebolb, the principal village of the Snohomish tribe. Its location near the mouth off the Snohomish River and next to Port Gardner Bay provided both abundant food and transportation. Native tribes used the Everett shoreline in part for subsistence activities such as shellfish collection, hunting, plant gathering, and fishing. According to local tribes, native long houses were located up and down the Everett waterfront. Local tribes have communicated to Ecology that the Everett waterfront is a culturally sensitive area. With that in mind, the SAP outlines procedures to be used in the event cultural resources are encountered during site activities.

Historic maps and aerial photographs of the project area were also consulted. Sanborn Fire Insurance Maps from the early part of the 20th century depict an emerging industrial area with a few wooden and temporary dwellings lining the historic shoreline of Port Gardner Bay. No information was found to suggest the Property was used as a formal dump/sanitary landfill that was accepting municipal refuse or trash from a wider geography.

### 3.0 PREVIOUS SITE INVESTIGATIONS AND INTERIM REMEDIAL ACTIONS

This section summarizes previous investigations and interim remedial activities undertaken at the Property and vicinity since 1985. From 1985 to 2009, extensive and focused investigations were undertaken by various consultants at the Property and off the Property. These investigations included drilling soil borings, installation of monitoring wells, test pit excavations, and collection and analytical testing of soil and groundwater samples. In addition, several interim remedial activities, including installation of LPH recovery trenches, manual LPH recovery, and capping the Property, have been conducted at the Property since 1988. Table 1 provides a chronology of previous investigations and interim remedial activities conducted at the Property and vicinity. Figure 15 shows the locations of historical explorations conducted on- and off-Property. Analytical data from previous investigations have been compiled by Ecology into a project database.

#### 3.1 Previous Environmental Investigations Conducted at the Site for Soil and Groundwater

A chronology of subsurface investigation activities conducted at the Property and surrounding area is presented below and in Table 1. Soil boring, test pit, and monitoring well logs are provided in Appendix C. A summary of current environmental conditions for soil and groundwater is presented in Sections 6.1 and 6.2, respectively.

In May 1985, RZA advanced five soil borings, B-1 through B-5, at the ExxonMobil Parcel. The borings were advanced using a hollow-stem auger (HSA) drill rig to depths ranging from 8.4 to 19 feet bgs. The borings were completed as 2-inch-diameter monitoring wells. No soil or groundwater samples were collected during this investigation. The monitoring wells B-1 through B-5 were named MW-1 through MW-5 in several later reports. RZA reported that petroleum odor was noticed in most of the borings, and evidence of contamination was also apparent below the water table. Specifically, petroleum odor or sheen on groundwater was observed in monitoring wells B-1, B-2, B-4, and B-5 (RZA, 1985).

In March 1988, RZA advanced 13 borings throughout the ExxonMobil Parcel to a depth of 11.5 feet bgs. The borings were completed as monitoring wells MW-6 through MW-18. RZA collected soil samples from the borings and groundwater samples from the monitoring wells. After monitoring well installation, 1.29 feet of LPH was measured in MW-14.

In January 1990, Environmental Science and Engineering, Inc. (ESE) advanced 19 hand-auger borings, AD-01 through AD-19, throughout the ADC Parcel to depths ranging from 1 to 4.5 feet bgs and collected soil samples from the borings.

In February 1990, ESE advanced seven HSA borings, W-1 through W-7, on and surrounding the ADC Parcel. Soil borings W-1 through W-6 were each advanced to a depth of 23 feet bgs and completed as 2-inch-diameter monitoring wells. Soil boring W-7 was advanced to the depth of 16 feet bgs and backfilled with bentonite upon completion. In June 1990, ESE advanced 10 hand-auger borings, including W-8 through W-17, to depths ranging from 6 to 10 feet. AMEC

was unable to identify soil analytical data for W-8 through W-17. However, gauging data indicate that free product was observed in 10 of the 17 monitoring wells located at and around the ADC Parcel. ESE suggested that a possible source for some LPH could be a railroad loading rack formerly located east of the ADC Parcel.

In October 1990, RZA collected grid soil samples B-1 through B-25 from the ExxonMobil Parcel using a hand auger. Soil samples were collected from depths ranging from 0.5 to 3 feet bgs. Two samples were studied for the purpose of conducting a slurry bio-feasibility study. Rapid biodegradation of total petroleum hydrocarbons (TPH) in the gasoline range (TPH-G) was observed. Biodegradation of TPH (undifferentiated) was not achieved.

Sometime prior to November 1990, monitoring wells B-3 (MW-3), B-4 (MW-4), and MW-7 were destroyed. AMEC was unable to locate records regarding well decommissioning.

In March 1991, RZA advanced six percussion soil borings to depths ranging from 5 to 5.5 feet bgs and installed 2-inch-diameter shallow monitoring wells MW-19 through MW-24. Wells MW-19, MW-20, and MW-21 were installed to the west of the ExxonMobil Parcel, and wells MW-22, MW-23, and MW-24 were installed at the possible source of free product at the railroad loading rack, to the east of the ADC Parcel. In June 1991, RZA installed two shallow 2-inch-diameter monitoring wells MW-25 and MW-26 on the west side of Federal Avenue. Because monitoring wells MW-25 and MW-26 were found to be either inaccessible or dry and no groundwater samples were collected, the wells were renamed as soil borings B-25 and B-26. On June 20, 1991, RZA installed four 4-inch-diameter monitoring wells MW-27, MW-28, MW-29, and MW-30, each to a depth of 13.5 feet bgs. These monitoring wells were installed to the east of the ADC Parcel. In addition, in June 1991, RZA advanced soil boring B-21-91 to a depth of 29 feet bgs along the eastern boundary of the ADC Parcel. This boring was backfilled with bentonite.

In November 1991, RZA AGRA installed an 8-inch-diameter recovery well, RW-2, and advanced soil boring B-1A to a depth of 31 feet bgs and soil borings B-8A and B-15A to depths of 29 feet bgs. Soil borings B-1A, B-8A, and B-15A were advanced in the vicinity of the existing monitoring wells B-1, MW-8, and MW-15. No soil analytical data for this drilling event were found.

In December 1993, RZA AGRA advanced seven off-Property borings MW-31 through MW-37 and completed six of the borings as 2-inch-diameter monitoring wells screened from 5 to 15 feet bgs. Soil boring MW-33 was advanced to 29 feet bgs and then backfilled up to 15 feet bgs. Soil boring B-34 was drilled and sampled but no well was installed at that location. Monitoring wells MW-31, MW-32, and MW-33 were installed to the west of the ExxonMobil Parcel, across Federal Avenue. A groundwater monitoring event followed monitoring well installation activities. Well B-1, MW-27, and MW-29 contained LPH and were not sampled. In addition, a ground-penetrating radar (GPR) survey was conducted to assess whether underground product lines had been removed. The GPR survey did not identify any linear subsurface features.

In December 1993, RZA AGRA excavated five test pits (TP-1 through TP-5) to depths ranging from 3 to 3.5 feet bgs. The test pits were associated with installation of a recovery trench along the western border of the ExxonMobil Parcel. Monitoring well MW-21 was decommissioned

during the recovery trench installation activities. However, the project database contains analytical results from 2002 for samples identified as originating from MW-21. These database entries may have been incorrectly identified.

In July 1995, RZA AGRA gauged monitoring wells located on the ADC Parcel. Wells W-9, W-12, and W-13 contained LPH.

RZA AGRA conducted a groundwater monitoring event in December 1995. Recovery well RW-2 and monitoring wells B-2, MW-8, MW-9, MW-18, MW-15 through MW-18, MW-27, and MW-28 were gauged. Wells RW-2, MW-9, MW-18, and MW-28 contained LPH and were not sampled.

In March 1996, AGRA advanced 13 push-probe soil borings, GP-1 through GP-13, to depths ranging from 9.5 to 12 feet bgs. These explorations were located generally to the north of the ADC Parcel and were associated with the CSO line repair (see Table 1). Soil samples were collected from the borings. No groundwater samples were collected from temporary screens installed in borings. Soil samples indicated that soil surrounding the damaged portion of the CSO line was impacted with petroleum hydrocarbons. LPH was also observed to accumulate in the temporary wells.

In May 1996, AGRA advanced 14 bobcat borings, BB-1 through BB-14, to depths ranging from 3 to 4 feet bgs at the ADC Parcel and collected soil samples. In addition, seven test pits (TP-1-96 through TP-7-96) were excavated throughout the ADC/Miller Parcel to depths ranging from 1.5 to 6 feet.

On June 5, 1996, AGRA advanced borings VRW-1 and MW-38 to depths of 15 feet bgs and 12.5 feet bgs, respectively, on the northeast corner of the Property. The borings were completed as 4-inch-diameter recovery well VRW-1 and 2-inch-diameter monitoring well MW-38. AGRA gauged wells in August 1996. LPH was found in B-1, VRW-1, MW-27, MW-29, MW-30, MW-38, W-1, W-9, and W-15.

Between November 1997 and January 1998, on behalf of Chevron, Texaco, KC, and BNSF, Pacific Environmental Group, Inc. (PEG), conducted an environmental investigation in the vicinity of several former petroleum bulk plants adjacent to the north and northwest of the Property. PEG advanced 15 soil borings using a hand-auger (Probe-1) and direct-push technology (Probe-2 through Probe-15) to depths ranging from 4 to 13 feet bgs. Borings Probe-7 to Probe-12 were advanced in the vicinity of the CSO line. PEG also advanced two soil borings inside the KC warehouse to depths of 16.5 feet bgs using a HSA drill rig and completed the borings as 2-inch-diameter monitoring wells, KC-1 and KC-2. Monitoring wells KC-1 and KC-2 were screened from 2 to 10 feet bgs and from 1.5 to 11.5 bgs, respectively. PEG submitted three soil samples to the analytical laboratory collected from borings Probe-7, Probe-11, and KC-1 at depths ranging from 3 to 8.5 feet bgs. Groundwater samples were collected from temporary screens installed in each probe (with the exception of Probe-1) and from the two monitoring wells KC-1 and KC-2. During drilling, PEG did not identify LPH in soil borings or monitoring wells. Detected concentrations of TPH-G, TPH in the diesel (TPH-D) and oil (TPH-O) ranges, and toluene in soil samples did not exceed MTCA Method A cleanup levels. Concentrations of TPH-D and TPH-O were detected above MTCA Method A cleanup levels in



groundwater samples collected from Probe-7 and Probe-11 (nearest to CSO line). Concentrations of TPH-O were also detected above MTCA Method A cleanup levels in groundwater samples collected from Probes 13 and -14. Concentrations of TPH-G, benzene, toluene, ethylbenzene, and xylenes (BTEX) were either below the laboratory detection limits or below the MTCA Method A cleanup levels in all groundwater samples. No soil samples were collected in the vicinity of the four ASTs formerly located at the Associated Oil Company property, which was located approximately 400 feet north of the ADC Parcel. One groundwater sample that was collected in the vicinity of the former Associated Fuel Tank Farm (Probe 4) had concentrations of TPH-D, TPH-G, and BTEX below the MTCA Method A cleanup levels. The PEG report (PEG, 1998) is included in Appendix D.

Between November and December 1998, the following groundwater monitoring wells were abandoned: MW-6, MW-8, MW-9, MW-12, MW-13, MW-15, MW-16, MW-17, MW-38, WP-1, B-1, B-2, W-4, W-8, W-11, W-12, W-14, AD-11, AD-12, AD-13, AD-15, AD-19, W-10, W-15, and MW-40. The well abandonment activities were associated with an interim remedial action conducted at the Property in January 1999, which included construction of an interceptor trench along the western and northern boundaries of the Property and a low-permeability cap over the entire Property (Table 1). In addition, nine 4-inch-diameter LPH recovery wells (LPH-1 through LPH-9) were installed in the interceptor trench in January 1999. A storm collection system that connects to the City of Everett sewer system was installed at the Property as part of the cap.

Three monitoring wells (W-10R, W-15R, and MW-40R) were installed on October 1, 1999, to replace abandoned wells W-10, W-15, and MW-40. The monitoring wells were screened from 4 to 14 feet bgs.

In December 1999, Dames and Moore performed geotechnical investigations associated with the California Street Overcrossing (CSTO) Project located at the intersection of California Street and Federal Avenue. Soil samples were collected for petroleum hydrocarbon analyses from borings DM-6, DM-7, and DM-8 located south and southeast of the Property. In September 2000, URS performed a Phase II investigation for the CSTO Project. Push-probe borings UG-1 to UG-12 (originally labeled GP-1 through GP-12) were advanced to the east and south of the Property to collect soil samples. Groundwater samples were collected from temporary screens installed in UG-2 and UG-8 (URS, 2000a).

Petroleum-affected soils along the overcrossing alignment extended from the west side of California Street to the middle of the KC parking lot. The contamination was found to be present generally from 4 to 5 feet bgs. The petroleum-affected soils extended over an area of approximately 25,600 square feet and on average were approximately 8 feet thick. Thus, approximately 7,600 cubic yards of petroleum-contaminated soil (PCS) was calculated to be present along the overcrossing alignment (URS, 2000a).

In July 2001, URS conducted a Phase II investigation on the Johnston Petroleum property adjacent to the south boundary of the ExxonMobil Parcel. URS advanced seven push-probe borings (JP-1 through JP-7) at the Johnston Petroleum parcel and collected soil samples. In addition, groundwater samples were collected from temporary screens installed in JP-1, JP-4, and JP-7. No TPH fractions or BTEX were detected above MTCA Method A cleanup levels in

the soil samples. The grab groundwater sample collected from JP-1 contained TPH-D and TPH-O above MTCA Method A cleanup levels. No TPH-G or BTEX was detected in groundwater samples collected within the Johnston Petroleum parcel (URS, 2001).

In February 2002, Environmental Resolutions, Inc. (ERI) abandoned monitoring wells MW-22, MW-23, MW-24, MW-35, and MW-37 and piezometer DM-6 due to the proximity of the CSTO construction project. Abandoned monitoring wells MW-22 through MW-24 were reported to be 5 feet deep, monitoring wells MW-35 and MW-37 were 15 feet deep, and piezometer DM-6 was 53 feet deep. ERI re-installed monitoring well W-2. Reportedly, well W-2 was screened from 3 to 23 feet bgs. No soil samples were collected during well installation activities. In addition, in July 2002 ERI abandoned shallow monitoring wells MW-20, MW-21, and an unidentified well located south of MW-21. The reported abandonment of MW-21 in 2002 contradicts the reported decommissioning of MW-21 due to installation of the recovery trench to the west of the Property in December 1995.

Since 2002, monthly water level gauging of monitoring wells at the Site; manual LPH removal from monitoring wells where more than 0.02-foot of LPH was detected; oleophilic sock installation and replacement in wells with LPH accumulations; and quarterly groundwater monitoring have been conducted at the Site by Kleinfelder, ERI, and most recently AMEC. The ongoing groundwater monitoring activities are being conducted pursuant to the groundwater monitoring program included in the 1998 Agreed Order (DE98TCP-N-223). The ongoing groundwater monitoring program is described in detail in Section 4.0.

In February 2007, AMEC contracted Bravo Environmental of Kenmore, Washington, to conduct a video survey of the storm drain system that connects to the City of Everett sewer system installed at the Property by Kleinfelder, Inc. (Kleinfelder), in 1999 as part of interim remedial measure (Section 3.2.6). The purpose of the video survey was to verify that groundwater from the Property is not infiltrating into the stormwater system through possible cracks and fissures in the piping and seven catch basins. No significant cracks or fissures within the storm water system were observed during the 2007 video survey.

In 2007, the frequency of groundwater monitoring was reduced to semiannual. In 2008, AMEC installed two additional off-Property wells (MW-A1 and MW-A2) along the west side of Federal Avenue (AMEC, 2008a) and performed a tidal study (AMEC, 2008b). On June 3, 2008, recovery wells LPH-1 through LPH-9 and monitoring wells W-1, W-2, W-3, W-6, W-10R, MW-10, MW-11, W-15R, W-17, RW-2, MW-19, MW-27, MW-28, MW-29, MW-30, MW-40R, and MW-A1 and MW-A2 were surveyed by a professional surveyor.

An investigation along a proposed City of Everett utility alignment adjacent to the perimeter of the Property was undertaken in February 2010. A copy of the SAP Addendum that addresses the activities associated with the investigation is provided in Appendix E.

### **3.2 Interim Remedial Actions**

Interim remedial actions and testing at the Property have included groundwater extraction and treatment, recovery trench installation, soil vapor extraction (SVE), excavation, manual LPH

recovery, LPH vacuum recovery, excavation dewatering, interceptor trench installation along the western and northern Property boundaries, and installation of a low-permeability cap over the entire Property. This section provides a brief description of each of the interim remedial actions.

### ***3.2.1 Infiltration Gallery in Vicinity of MW-14***

LPH at a depth of 1.29 feet was observed in monitoring well MW-14 in April 1988. At that time, RZA evaluated the feasibility of extracting LPH beneath the ExxonMobil Parcel by installing a recovery trench, vapor extraction system, and groundwater treatment system consisting of an oil/water separator coupled with an air stripper. In May 1988, an infiltration gallery was installed in the vicinity of MW-14. The infiltration gallery was "T"-shaped and approximately 45 feet long. Construction activities consisted of trench excavation and installation of two modified 55-gallon drums as sumps. The trench was subsequently filled with 1.5-inch-diameter washed gravel with 8 to 12 inches of surrounding ground surface (removed in 1999). On May 12, 1988, a vacuum truck pumped subsurface fluids from the sumps; 1,400 gallons of liquid was removed from the sumps, approximately 50 gallons of which was LPH. As a result of this interim remedial action, the LPH thickness in MW-14 decreased to 0.40 feet in August 1988.

### ***3.2.2 Groundwater Extraction and Treatment***

In March 1989, an automated groundwater extraction and treatment system was installed by RZA in the location of the May 1988 infiltration gallery. The system consisted of a fluid extraction sump situated in RW-1 (formerly MW-14), an oil-water separator, an air stripper, and a re-infiltration gallery. The re-infiltration gallery, which was approximately 100 feet long, was constructed parallel to the north side of the ExxonMobil Parcel. It consisted of a perforated, 4-inch-diameter polyvinyl chloride (PVC) pipe surrounded by pea gravel within the excavated trench. The groundwater extraction and treatment system operated at a pumping rate of approximately 2 to 3 gallons per minute (gpm). However, no measurable quantities of LPH were removed, and no LPH was observed in recovery well RW-1. In August 1989, 0.68 and 0.73 feet of LPH was measured in MW-8 and MW-18, respectively. Approximately 7 gallons of free product and oily water were hand bailed from both wells and disposed of in the oil-water separator of the groundwater treatment system at the Property. The groundwater extraction and treatment system was shut down in March 1990 because of flooding of the re-infiltration gallery and has not been restarted.

### ***3.2.3 Recovery Trench In the Vicinity of Side Sewer***

In December 1993, an LPH recovery trench was installed on the southwest corner of the ExxonMobil Parcel. The trench was installed in a north-south orientation, to a depth of approximately 4 feet bgs. Two recovery wells that consisted of 8-inch-diameter, schedule 40 PVC screens were placed to a depth of approximately 7 feet in the trench. The trench was backfilled with 7/8-inch-diameter round rock to a depth of approximately 3 feet. The rock was overlain by a filter fabric and covered with compacted pit run, followed by placement of approximately 6 inches of crushed rock over the pit run to bring the excavation to grade. Concrete vaults were then placed over the recovery wells. Underground PVC piping was extended from the vaults to the remediation equipment compound located on the ExxonMobil

Parcel for future access to LPH recovery equipment. Soil excavated during construction was stockpiled on the Property, covered with visqueen, and later disposed of at an external facility.

No LPH accumulated in the recovery trench, and no LPH was recovered from the trench. The trench was re-examined in August 1996; no LPH accumulation was evident.

### ***3.2.4 Combined Sewer Overflow Line Repair***

In October 1995, discharge of petroleum product into Everett Harbor from a CSO line prompted an investigation by the U.S. Coast Guard (USCG) Puget Sound Marine Safety Office and the City of Everett to assess the source of the hydrocarbons. The outfall is located on the west side of the 2700 block of Federal Avenue, approximately 175 yards northwest of the ADC Parcel. Camera surveys of the sewer lines that flow to the outfall revealed LPH seepage in the section of the CSO line that runs approximately 40 feet north of the northern boundary of the ADC Parcel. The section of pipe in which the infiltration was observed during the camera survey was discovered to be made of clay tiles that had settled and cracked. On April 16, 1996, a meeting was held at the City of Everett to discuss options for repairing the broken section of the CSO line. The repair option selected at the meeting consisted of replacement of the settled portion of the line and slip lining of the remaining portion of the line.

In June 1996, AGRA began repair activities on the CSO line. The settled portion of the pipe, approximately 25 feet long, was excavated and replaced. Another section of pipe, which was approximately 20 feet long and made of metal, was found to be corroded and out of round. This section of pipe was also excavated and replaced. The excavation to repair the CSO line in this area was approximately 125 feet long. The remaining portions of the CSO line were slip-lined to eliminate the potential for leakage of LPH through the joints of the intact sections of the existing pipe. During the excavation activities, LPH was observed entering the excavation from the wood waste layer where this layer intercepted both the north and south sidewalls. Three 36-inch-diameter, 22-foot-deep dewatering wells (DW-1 through DW-3) were installed prior to excavation of the CSO line. Dewatering was performed throughout the excavation to allow for repair of the CSO line. Throughout construction, pumps operated alternately, both within the CSO line excavation and within the three dewatering wells. The recovered liquid was transferred to an 18,000-gallon baffled tank, then to two 21,000-gallon settling tanks, and finally to an 18,000-gallon baffled tank. Reportedly 1,450,800 gallons of groundwater and 23,050 gallons of LPH were removed during CSO line excavation dewatering activities. During repair of the CSO line, daily LPH recovery volumes varied from 0 gallons to 7,550 gallons. Approximately 80 percent of the total LPH recovered was removed in the first 6 days of CSO line excavation dewatering.

Oleophilic sorbent booms were installed to absorb and contain LPH discharging into Port Gardner Bay. During CSO excavation and repair activities, sorbent pads, oil sweeps, and/or soil snares, sorbent booms, and a mechanical skimmer were used to contain and recover the floating petroleum to the extent practicable.

### **3.2.5 LPH Vacuum Recovery Pilot Test**

In May and June 1996, AGRA conducted an LPH recovery pilot test at the Property. The recovery system consisted of SVE and groundwater/LPH pumping systems installed on the newly installed 4-inch vacuum recovery well (VRW-1) located in the northeast corner of the ADC Parcel. The SVE system discharged directly to the atmosphere, while the groundwater/LPH pumping system transferred the extracted liquid to a 500-gallon LPH settling tank, then to a 6,900-gallon groundwater storage tank. The test was performed for 14 days. During that time, approximately 125 gallons of LPH and 28,228 gallons of groundwater were removed from VRW-1. AGRA concluded that overall efficiency of LPH recovery during the test was 0.43 percent. Daily LPH removal rates could not be measured during the test because of emulsification of LPH with groundwater. LPH thickness in VRW-1 decreased from 9.41 feet to no measurable thickness in 14 days. LPH in MW-38 (observation well) decreased slightly, however, LPH thickness and water levels varied significantly throughout the 14 days of testing. AGRA concluded that the variability of groundwater levels in MW-38 may indicate that this area of the Property is tidally influenced. The thickness of LPH was measured in VRW-1 and MW-38 a month after the recovery pilot testing. Wells VRW-1 and MW-38 contained 1.35 and 0.29 feet of LPH, respectively.

In addition, LPH was removed with a vacuum truck from a test pit (TP-6-96) in May 1996. LPH did not recharge into test pit TP-6-96 during a 2-week period, and no additional LPH was removed. Ecology has since agreed that active removal of LPH is not a viable technology.

### **3.2.6 Water Management and Treatment System and Asphalt Cap Construction**

In February 1997, PTI prepared a memorandum summarizing environmental investigations, LPH recovery activities, and geology of the Site and vicinity (PTI, 1997a). The memorandum stated that long-term, passive (LPH only) recovery was effective in removing LPH. The memorandum also stated that active LPH and groundwater recovery that had been performed up to that time had been effective for short durations, but recovery structures did not continue to recover LPH for extended periods of time when active recovery was employed.

In July 1998, on behalf of Mobil Oil Corporation, ADC, and Mr. A. P. Miller, Exponent prepared a Remedial Investigation and Focused Feasibility Study for the Property (Exponent 1998a). In this study, Exponent summarized the history of the Property and evaluated feasible remedial options for the Site. To achieve the remedial objective, Exponent recommended the installation of LPH recovery trenches and a low-permeability cap over the Property.

In November 1998, Kleinfelder completed an initial survey evaluation of the Property. Kleinfelder also performed an asbestos survey prior to demolition of structures on the Property. Asbestos was found to be present in buildings on the Property, and asbestos abatement was conducted by Performance Abatement Services between November 12 and 17, 1998. Demolition activities at the Property were completed in January 1999. Structures that were demolished on the ADC Parcel included four buildings (an office building, oil pump house building, a warehouse, and boiler room), aboveground piping, loading racks, the firewall (including 40 feet of foundation of the wall in the northeast corner of the Property), and the AST pad. In addition, a trench that was

installed in 1988 in the vicinity of MW-14/RW-1 was demolished. Two modified 55-gallon drums that had been used as sumps were filled with concrete.

Kleinfelder conducted interim remedial actions at the Property from the end of 1998 throughout 1999. These actions consisted of monitoring well abandonment, clearing and grubbing of the ExxonMobil Parcel, demolition of structures on the ADC Parcel, demolition of the firewall on the ADC Parcel, construction of an interceptor trench, abandonment of underground utilities, installation of a downgradient liner and LPH collection piping, installation of a low-permeability cap, and installation of a storm drain system. Demolition activities at the Property were completed in January 1999.

Approximately 162 tons of contaminated shallow soil and vegetation were removed from within the ADC firewall area that was situated on the northern portion of the ADC Parcel surrounding the former ASTs. The soil was disposed of at TPS Technologies in Lakewood, Washington. Approximately 3.5 tons of Class 3 PCS was taken to CRS Associated located in Everett, Washington. Marine Services, Inc., removed 110 gallons of purge water for recycling at an external facility.

Between December 1998 and September 1999, the water management and treatment system constructed at the Property in 1998 treated approximately 2.5 million gallons of water from the Property. The water was treated using an oil-water separator, a settling tank, and a carbon polishing unit. The water then discharged via the storm sewer system to the Everett Water Pollution Control Facility, in accordance with project-specific City of Everett Industrial Waste Discharge Permit No. 154. Approximately 19,900 gallons of oily water and 450 gallons of sludge were collected at the Property between December 1998 and September 1999. Sources of oily water included recovered product from underground pipes prior to removal; water from tank washing prior to removal; water skimmed from excavated areas during interceptor trench construction; and water skimmed from the water treatment system product overflow and flow equalization tanks.

From August to September 1999, cap construction activities were performed and included complete grading of the Property, installation of two layers of geotextile fabric along the entire trench, installation of asphalt-treated base material and paving fabric, and installation of the asphalt cap.

In January 1999, an interceptor trench was constructed along the western and northern Property boundaries. The trench utilized the existing concrete footing structure that is 7 feet deep with an impermeable liner placed over the downgradient side of the trench contiguous with the footing. The trench was backfilled with uniform washed gravel and was constructed to the current grade. Lateral piping and vaults were installed during construction of the Property cover in September 1999. Nine 4-inch-diameter LPH recovery wells (LPH-1 through LPH-9) were installed in the trench.

### ***3.2.7 LPH Bailing and Groundwater Monitoring***

Manual bailing of LPH from wells that contain a measurable amount of LPH has been performed on a daily, weekly, and later on a monthly basis since December 1991. LPH recovery activities currently conducted at the Property are based on the groundwater monitoring program included in Ecology's 1998 Agreed Order (DE98TCP-N-223).

The current monthly LPH monitoring consists of water level gauging of nine recovery wells (LPH-1 through LPH-9) and 16 monitoring wells (W-1, W-2, W-3, W-6, MW-10, W-10R, MW-11, W-15R, W-17, MW-18, MW-19, MW-27, MW-28, MW-29, MW-30, MW-40R), LPH removal from select monitoring wells, and replacement of oleophilic socks in wells with measurable accumulations of LPH. More details on the ongoing LPH recovery program are provided in Section 4.0.

### ***3.2.8 Puget Sound Outfall 5 Overflow Structure Project***

In July 2008, on behalf of the City of Everett Utilities Department, Floyd | Snider collected soil and water samples from an excavation at the CSO Puget Sound Outfall 5 (PSO 5) Overflow Structure (Figure 15). The overflow structure was built to control overflows from the CSO into Puget Sound. The project was located to the north-northeast of the Property. Water samples were analyzed during excavation dewatering to verify that water discharged to the City sewer system met the requirements of the City's industrial pretreatment requirements. Soil samples were collected to characterize soils for disposal. Soil samples were screened in the field. Soil samples that exhibited signs of contamination were not sampled, but instead disposed of under a Class III soil profile. Apparently clean soil samples were sampled per disposal specifications and disposed of as Class II soils. Appendix B contains the City of Everett's letter to Ecology and analytical data. The locations and depths of contaminated soil were not identified by Floyd | Snider or the City of Everett.

## 4.0 ONGOING GROUNDWATER MONITORING/PETROLEUM RECOVERY

Periodic groundwater monitoring has been conducted at the Site since the early 1990s and became regular in 2002, pursuant to the groundwater monitoring program included in Ecology's 1998 Agreed Order (DE98TCP-N-223). The monitoring program includes (1) petroleum recovery and (2) collection and analytical testing of groundwater samples. The groundwater samples were collected on the quarterly basis and the LPH recovery was conducted monthly. In 2007, the groundwater monitoring frequency was reduced to semiannual.

### 4.1 Petroleum Recovery

Manual bailing of LPH from wells that contain measurable accumulations of LPH has been performed on a daily, weekly, or monthly basis since December 1991. The current LPH monitoring program is performed monthly and consists of:

- Water level gauging of nine recovery wells (LPH-1 through LPH-9) and 16 monitoring wells (W-1, W-2, W-3, W-6, MW-10, W-10R, MW-11, W-15R, W-17, MW-18, MW-19, MW-27, MW-28, MW-29, MW-30, MW-40R),
- LPH removal from monitoring wells where more than 0.02 foot of LPH is detected, and
- Replacement of oleophilic socks in wells with measurable accumulations of LPH.

LPH gauging during the most recent semiannual groundwater monitoring event conducted in February 2009 produced the following results.

- The thickness of LPH in LPH-9 fluctuates from no detectable LPH to 0.16 feet.
- The thickness of LPH in W-1 fluctuates from 0.06 to 0.93 feet.
- The thickness of LPH in W-2 fluctuates from no detectable LPH to 0.75 feet.
- The thickness of LPH in MW-29 remains greater than 1 foot.

The average thickness of LPH measured from September 2008 to February 2009 during monthly monitoring events is shown on Figure 20.

### 4.2 Monitoring of Groundwater Quality

From 2002 to 2007, groundwater samples were collected quarterly from five monitoring wells: MW-11, MW-19, MW-40R, W-3, and W-6. In 2007, the frequency of groundwater monitoring was reduced from quarterly to semiannually. This change in the frequency of groundwater monitoring was verbally accepted by Ecology in February 2007 and verified in a letter dated May 8, 2007. The accepted revised groundwater monitoring schedule was confirmed in a meeting with Ecology on August 8, 2007. Two off-Property monitoring wells (MW-A1 and MW-A2) installed in 2008 are also included in the groundwater gauging and monitoring network.

Groundwater samples are collected using a peristaltic pump and dedicated disposable tubing. The purge water is monitored for field water quality parameters (temperature, pH, specific



conductivity, turbidity, dissolved oxygen, and oxidation-reduction potential) recorded at 5-minute intervals using a Horiba U-22 water quality meter.

Groundwater samples are submitted to Test America Laboratories in Bothell, Washington, for the following analyses:

- TPH-G using Ecology Method Northwest Total Petroleum Hydrocarbons-Gasoline extended (NWTPH-Gx);
- TPH-D and TPH-O using Ecology Method Northwest Total Petroleum Hydrocarbons-Diesel extended (NWTPH-Dx); and
- BTEX using U.S. Environmental Protection Agency (EPA) Method 8020.

The February 2009 groundwater monitoring results produced the following findings.

- The direction of the hydraulic gradient is toward the west to northwest.
- Groundwater samples from monitoring wells MW-11, MW-19, MW-A1, MW-A2, W-3, and W-6, contained concentrations of BTEX below the analytical detection limits. MW-40R contained BTEX concentrations at detectable levels but below MTCA Method A cleanup levels. Concentrations of TPH-G were detected in MW-19, MW-40R, MW-A1, MW-A2, W-3, and W-6. Groundwater from MW-40R contained a TPH-G concentration that exceeded MTCA Method A cleanup levels.
- TPH-D and TPH-O were detected in groundwater samples from monitoring wells MW-19, MW-40R, MW-A1, MW-A2, W-3, and W-6. TPH-D concentrations in all the above wells were above MTCA Method A cleanup levels except monitoring well W-6. TPH-O was detected in the same well set and concentrations only exceeded MTCA Method A cleanup levels in monitoring well MW-40R.
- Groundwater samples from monitoring well MW-11 did not contain analytes at concentrations above the laboratory detection limits.

Analytical results for the August 2008 and February 2009 monitoring events are presented on Figure 21. Analytical results from groundwater monitoring are discussed in detail in Section 6.3

## 5.0 PRELIMINARY SCREENING LEVELS

This section was prepared consistent with Ecology MTCA cleanup rules (WAC 173-340) and establishes preliminary screening levels for soil and groundwater. Based on the data collected during the Data Gap Investigations and remedy selection criteria under MTCA, the site-specific cleanup levels and, if necessary, remediation levels will be established.

### 5.1 Preliminary Soil Screening Levels

The applicable MTCA Method A and/or MTCA Method B soil cleanup levels (WAC 173-340-700) are presented along with analytical results for indicator hazardous substances (IHSs) in soil in Tables 2 through 4. Petroleum constituents have been identified in soil samples located off-Property, and therefore MTCA Method A cleanup levels for residential/unrestricted land use will serve as preliminary screening levels for total petroleum hydrocarbons BTEX and carcinogenic polycyclic aromatic hydrocarbons (cPAHs). MTCA Method A cleanup levels for industrial land use will be used as preliminary screening levels for lead since the Property will remain in industrial use for the foreseeable future and existing concentrations of lead in groundwater are below its screening level. Noncarcinogenic polycyclic aromatic hydrocarbons (PAHs) were compared to MTCA Method B residential/unrestricted cleanup levels.

The MTCA Method A unrestricted and industrial (applicable to lead only) land use were selected as preliminary screening levels based on the following considerations: (1) levels protective of human health and the environment for direct contact, inhalation, and ingestion; and (2) levels protective of groundwater. In addition, soil concentrations considered protective of terrestrial receptors (plants and animals) were assessed using a simplified terrestrial ecological evaluation (WAC 173-340-7492). A copy of the evaluation is presented in Appendix F.

### 5.2 Preliminary Groundwater Screening Levels

The applicable MTCA Method A and/or MTCA Method B groundwater screening levels (WAC 173-340-720) are presented along with analytical results for IHSs in groundwater in Tables 5 through 7. Although the groundwater on the Site is not currently used for potable purposes, preliminary screening criteria for the Site will be established for use of groundwater as potable water. However, based on the historical and current industrial use of properties surrounding the Property, it is not likely that groundwater at the Site could potentially be a future source of drinking water (WAC 173-340-720(2)(c) and (d)). The groundwater to surface water pathway will be evaluated as part of the FFS after the data gaps investigation. In the event that IHS's are in contact with surface water, screening criteria will be re-evaluated for groundwater. If it is determined that surface water is not impacted then groundwater will be evaluated in the context of partition since groundwater is considered non-potable. This screening criterion will be based on a MTCATPH calculated value for TPH and Method B or C for other components.

## 6.0 SUMMARY OF CURRENT ENVIRONMENTAL SITE CONDITIONS

This section summarizes environmental conditions for soil and groundwater at the Property and vicinity, based on results of historical and recent investigations. Soil samples for chemical analyses have been collected from soil borings, test pits, and trench and test pit excavations on the Property and in the vicinity of the Property. Groundwater samples for chemical analyses have been collected from temporary wells and groundwater monitoring and recovery wells. Analytical results of the soil and groundwater samples indicate that heavy-range petroleum hydrocarbons are distributed in soil and groundwater across the Property and vicinity. LPH has been observed in the soil and floating on the water table. TPH-G, BTEX, PAHs, and lead have also been reported to be present in soil and groundwater samples.

Soil and groundwater data collected at the Site since 1988 were imported into a Microsoft Access database and will ultimately be put into the Ecology EIM system. Analytical results for soil samples are presented in Tables 2 through 4. Analytical results for groundwater samples are presented in Tables 5 through 7.

The concentrations of detected chemicals in groundwater are compared against the MTCA Method A cleanup levels for groundwater (drinking water-based). The concentrations of selected PAH compounds with no established MTCA Method A cleanup level are screened against MTCA Method B cleanup levels (Table 7).

### 6.1 Soil

The general geology, based on the previous subsurface investigations conducted at the Property and its surroundings, is described in Section 2.4.2. Soil boring, monitoring well, and test pit logs are compiled in Appendix C. The stratigraphy underlying the Site is displayed on geologic cross-sections A-A', B-B', and C-C', which are presented on Figures 16 through 18, respectively. The locations of the cross sections are shown on Figure 15.

The thickness and continuation of the silt/clay layer was not completely assessed during previous subsurface investigations. Below is the list of deeper borings drilled in the area that encountered Quaternary-aged transitional beds in the borings. Boring locations are shown on Figure 15.

- B-21 was drilled to 29 feet bgs by RZA in 1991. No silt/clay was encountered to the total depth of the boring. Native sand was encountered at 27 feet bgs.
- MW-33 was drilled to 29 feet bgs. The silt/clay layer was encountered at 25 feet bgs and continued to the total depth of the boring.
- W-2, W-3, and W-6 were drilled to 23 feet bgs. Organic silt (silt/clay) was recorded in each boring at 20 feet bgs and extended to the total depths of the borings.
- B-1A and B-15A were drilled to 30 and 29 feet bgs, respectively. No silt/clay layer was encountered in either boring.

- MW-A1 and MW-A2 were drilled to 26.5 feet bgs. An organic silt/clay layer was encountered from 23 to 25 feet bgs in MW-1A and from 17.5 to 21 feet bgs in MW-2A. In both borings, the layer of silt/clay is underlain by native sand.

Analytical results for soil samples are presented in Tables 2 through 4. The concentrations of detected chemicals in soil reported in Table 2 through 4 are compared with MTCA Method A soil cleanup levels (see Section 5.1). The concentrations of selected PAH compounds presented in Table 4 with no established MTCA Method A soil cleanup level were compared instead with MTCA Method B cleanup levels.

Soil samples have been collected at the Site at various depths and analyzed for the following:

- Petroleum hydrocarbons by EPA Method 8015 Modified and/or 418.1 and Ecology Methods NWTPH-D, NWTPH-Dx, and NWTPH-Gx;
- Oil and grease by EPA Method 413;
- BTEX by EPA Method 8020;
- Semivolatile organic compounds (SVOCs) by EPA Method 8310; and
- Lead by EPA Method 7421.

The majority of the analyzed soil samples were collected from above the water table and/or at the capillary fringe at approximate depths ranging from 0 to 5 feet bgs. Approximately one-third of the analyzed samples were collected at depths ranging from 5 to 14 feet bgs. However, the extent of petroleum contamination (odor and/or discoloration) in soil was evident in several borings to depths of up to approximately 16 feet bgs.

The following subsections summarize the current environmental conditions at the Site for each IHS identified in Section 7.4.

#### **6.1.1 TPH-D, TPH-O, and TPH (undifferentiated)**

Soil analytical data for TPH-D, TPH-O, and TPH (undifferentiated) are displayed on Table 2. In this discussion, analytical results for undifferentiated TPH are assumed to be representative of TPH-D, since predominantly diesel-range hydrocarbons have been detected at the Site. The horizontal and vertical distributions of TPH-D and TPH (undifferentiated) in soil are shown on Figures 22 through 25. TPH-D has been found in soil samples collected throughout the Property and adjoining parcels, but not in samples collected on the Johnston Petroleum property adjacent to the southern boundary of the Property (Figure 22). Concentrations of TPH-D and undifferentiated TPH have been detected above the MTCA Method A cleanup level of 2,000 milligrams per kilogram (mg/kg) in samples collected on both Parcels (Figure 22). TPH-D has also been detected in soil samples collected to the north, west, and east of the Property. The vertical extent of TPH-D ranges from near the surface to near the water table (0.5 to 5 feet bgs). Several samples collected below the groundwater table exhibited TPH-D, TPH-O, or TPH (undifferentiated) contamination (Figures 23 through 25). Soil samples with concentrations of TPH-D and/or TPH-O above the MTCA Method A cleanup levels were collected from borings

B-34 and UG-9 (located to the east of the ExxonMobil Parcel) at approximate depths ranging from 10 to 14 feet bgs, GP-9 (located to the north of the Property) at an approximate depth of 8 feet bgs, and MW-A1 and MW-A2 (located to the west of the ADC Parcel) at approximate depths ranging from 7.5 to 9 feet bgs.

The extent of TPH-D impact in soil hydrogeologically downgradient (west and northeast of the Property) cannot be inferred based on existing data. This is considered to be a data gap that will be addressed in the data gaps investigation.

### **6.1.2 TPH-G**

Soil analytical data for TPH-G (with BTEX and lead) are shown on Table 3. The horizontal and vertical distribution of TPH-G detected in soil samples is shown on Figures 26 through 29. Historical analytical data are not available for TPH-G in soil samples collected within the Property. TPH-G was not detected above 30 mg/kg (MTCA Method A cleanup level if benzene is present) in soil samples collected to the south and southwest of the Property. TPH-G greater than 30 mg/kg and less than 100 mg/kg was noted in the southwest of the Site, and concentrations greater than 100 mg/kg were noted to the northwest, north and east of the Site (Figure 26). The western (downgradient) extent of TPH-G impact in soil cannot be inferred based on existing data and this is considered to be a data gap that will be addressed in the investigation.

### **6.1.3 Benzene, Toluene, Ethylbenzene, and Total Xylenes**

Soil analytical data for BTEX are shown on Table 3. The horizontal and vertical distribution of benzene detected in soil samples is shown on Figure 30. The horizontal distribution of toluene, ethylbenzene, and total xylenes is shown on Figures 34 through 36, respectively. Soil samples containing concentrations of benzene greater than the MTCA Method A cleanup level of 0.03 mg/kg have been collected from three general areas: the center of the ExxonMobil Parcel; off-Property to the east; and one location off-Property to the northwest (Figure 30). In the case of the first two of these areas, surrounding samples did not have reportable concentrations of benzene. However, the majority of the soil samples were analyzed for BTEX using EPA Method 8020. This analytical method has benzene detection limits greater than the MTCA Method A cleanup level of 0.03 mg/kg. The extent of benzene impact in soil within the center of the ExxonMobil Parcel and off-Property to the east cannot be inferred based on existing data and is considered a data gap that will be addressed in the data gaps investigation.

### **6.1.4 Lead**

Soil analytical data for lead are shown on Table 3. The horizontal and vertical distribution of lead in soil is shown on Figures 37 through 40. Historical analytical data for lead are not available for soil samples collected within the ExxonMobil Parcel. No soil samples collected at the Property or neighboring properties contained lead at concentrations above the MTCA Method A cleanup level for industrial land use of 1,000 mg/kg. No lead impact in soil was identified because soil samples did not have lead concentrations above the MTCA Method A cleanup level for industrial land use.

### 6.1.5 PAHs

Soil analytical data for PAHs are shown on Table 4. Soil samples collected within the Property boundaries have not been analyzed for PAHs. Soil samples for PAH analyses have been collected from 15 locations on neighboring parcels. Noncarcinogenic PAHs were detected in soil samples, but none was found at concentrations that exceeded MTCA Method B cleanup levels. Samples collected west of the Property have not contained detectable concentrations of PAHs. Because no noncarcinogenic PAHs were detected above MTCA Method cleanup levels A (or MTCA Method B if no value for Method A was available), analytical results for noncarcinogenic PAHs are not mapped. cPAH concentrations were evaluated in the context of toxicity equivalencies (WAC 173-340-708(8)(e)). The toxicity equivalent quotients (TEQs) were calculated by assigning one-half of the method reporting limit for nondetected compounds multiplying by their assigned TEQ value and summed. Four soil samples collected at locations north and south from the Property (GP-7, GP-8, GP-9, and MW-32), contained benzo(a)pyrene and/or TEQ-adjusted concentrations of total cPAHs above the MTCA Method A cleanup level for residential land use of 0.1 mg/kg. The horizontal and vertical distribution of TEQ-adjusted concentrations of total cPAHs in soil is shown on Figures 41 and 42, respectively.

### 6.2 Liquid-Phase Hydrocarbons

Historically, LPH has been observed at greater than trace thicknesses primarily in the northern portion of the Property and on nearby adjacent parcels (Figure 43). Trace amounts of LPH have also been observed on the southern portion of the ExxonMobil Parcel. The observed presence of LPH has largely been associated with wood debris in explorations. It is possible that peat layers are acting as confining layers for the migration of LPH. LPH has not been observed in off-Property wells to the northwest. LPH typing analysis has indicated that LPH recovered from the Property had characteristics of a range of products including degraded diesel mixed with degraded gasoline and heating oil.

The current monthly LPH monitoring regime is described in Section 4.0. The table below lists the maximum thickness of LPH measured in wells with more than trace amounts of LPH at the Property and neighboring parcels since 2002.

#### Maximum Measured Thickness of LPH

Well Type	Well Name	Maximum LPH Thickness in Feet	Month and Year Measured
Recovery	LPH-5	4.21	January 2003
Recovery	LPH-7	0.01	November 2007
Recovery	LPH-8	0.01	February 2006
Recovery	LPH-9	0.16	October 2008
Monitoring	W-1	4.42	October 2005
Monitoring	W-2	7.43	June 2002
Monitoring	W-10R	1.00	July 2003
Monitoring	W-17	0.1	March 2002
Monitoring	MW-27	2.60	March 2005
Monitoring	MW-29	7.18	October 2002

The maximum thickness of LPH measured in wells at the Property and neighboring parcels since 2002 is displayed on Figure 43.

### **6.3 Groundwater**

Shallow unconfined groundwater occurs at the Site at depths of 1 to 5 feet bgs. Previous groundwater elevation data indicate fluctuations between high and low seasonal water tables of up to 3 feet. Based on the historical groundwater elevation data, groundwater beneath the Property flows generally to the west and to the northwest (Figure 19). The groundwater gradient across the Property averages 0.0455 feet/foot as calculated between wells W-6 and MW-A1.

A 24-hour aquifer test was conducted by RZA AGRA Earth & Environmental, Inc. (RZA AGRA) in December 1991. The aquifer test consisted of pumping groundwater from monitoring well MW-10 at a rate of approximately 1 to 2 gallons per minute and measuring the response in monitoring well MW-18 and recovery wells RW-1 and RW-2. The radius of influence included most of the northeastern quarter of the ExxonMobil Parcel. The aquifer test results indicated that the hydraulic conductivity at the Property ranges from 4.0 to 9.5 feet/day.

According to deep boring logs, no deeper groundwater was encountered. The soils (both silt/clay and sand) become moist at approximately 23 feet bgs in all borings except at MW-1A and MW-2A, where the sand beneath the silt/clay was reported to be saturated.

Groundwater samples collected at the Property and neighboring parcels have been analyzed for one or more of the following analytes: petroleum hydrocarbons by EPA Method 8015 Modified and Ecology Methods NWTPH-D, NWTPH-Dx and NWTPH-Gx; BTEX by EPA Method 8020; VOCs by EPA Method 602 (analytical data not found for VOCs except for BTEX); SVOCs by EPA Method 8310; and total and dissolved lead by EPA Method 7421.

#### **6.3.1 TPH-D or TPH (undifferentiated)**

Groundwater analytical data for TPH-D, TPH-O, and TPH (undifferentiated) are shown on Table 5. The historical distribution of TPH-D, TPH-O, and TPH (undifferentiated) in groundwater is shown on Figure 44. TPH-D has been detected at concentrations above the MTCA Method A cleanup level of 500 micrograms per liter ( $\mu\text{g/L}$ ) throughout the ExxonMobil Parcel and to the west, south, and east of the Property. Historical analytical results for TPH-D and TPH (undifferentiated) in groundwater are limited for the ADC Parcel. However, groundwater samples collected from monitoring wells MW-A1 and MW-A2, both located west of the ADC Parcel, have contained TPH-D and TPH-O at concentrations above the MTCA Method A cleanup level. The extent of downgradient TPH-D impact cannot be inferred based on available data, because no data to the west of monitoring wells MW-A1 and MW-A2 exist. This is considered to be a data gap that will be addressed in the data gaps investigation.

#### **6.3.2 TPH-G**

Groundwater analytical data for TPH-G are shown on Table 6. The historical distribution of TPH-G in groundwater is shown on Figure 45. TPH-G has been detected at concentrations above the MTCA Method A cleanup level of 1,000  $\mu\text{g/L}$  if benzene is not present and 800  $\mu\text{g/L}$  if

benzene is present primarily on the ExxonMobil Parcel and along the eastern boundary of the ADC Parcel. Historical groundwater TPH-G data are limited for the ADC Parcel. TPH-G has also been detected at concentrations greater than 1,000 or 800 µg/L in samples collected off-Property to the east and northeast. A groundwater sample collected from MW-22 in December 1991 contained TPH-G with a concentration exceeding the MTCA Method A cleanup level. Concentration of TPH-G in groundwater sample collected from W-6 in February 2009 was reported below MTCA Method A cleanup levels. Monitoring well W-6 is located at the eastern portion of the Property. In addition, eastern monitoring wells W-17 and MW-27 through MW-30 contain various amount of LPH (Figure 43). TPH-G impact to the east of the Property will be further investigated in the data gaps investigation.

### ***6.3.3 Benzene, Toluene, Ethylbenzene, and Total Xylenes***

Groundwater analytical data for BTEX are shown on Table 6. The historical distribution of benzene, toluene, ethylbenzene, and total xylenes in groundwater is shown on Figures 46 through 49, respectively. Historical analytical data for benzene in groundwater are limited for the ADC Parcel. Benzene has been detected at concentrations above the MTCA Method A cleanup level of 5 µg/L primarily on the ExxonMobil Parcel and to the east of the Property. Benzene has not been detected in groundwater samples collected south or west of the Property. Benzene concentration were reported in groundwater samples collected from monitoring wells MW-40R, MW-11, MW-19, MW-40R, MW-1A, MW-2A, W-3, and W-6) in February 2009 had either below the laboratory detection limits or below the MTCA Method cleanup levels. No ethylbenzene and/or toluene was detected at concentrations above the respective MTCA Method A cleanup level. One sample collected from MW-18 in 1988 had a concentration of total xylenes exceeding the MTCA Method A cleanup level. The extent of benzene impact downgradient of the Property can be inferred to be within the Federal Avenue right-of-way based on the fact that benzene was not detected in samples collected from MW-A1 and MW-A2, which are west of Federal Avenue. The extent of benzene impact upgradient from the Property can be partially inferred based on the fact that benzene was not detected in samples collected from monitoring wells MW-27 and MW-28. The extent of upgradient benzene impact can be inferred to be east of these monitoring wells and will be confirmed in the data gaps investigation. The extent of upgradient benzene impact to the east of the Property and south of MW-28 cannot be inferred based on available data, and is considered to be a data gap that will be addressed in the data gaps investigation.

### ***6.3.4 Total and Dissolved Lead***

Groundwater analytical data for total and dissolved lead are shown on Table 6. The historical distribution of total and dissolved lead in groundwater is shown on Figures 50 and 51, respectively. Total lead has been detected at concentrations above the MTCA Method A cleanup level of 15 µg/L in groundwater samples collected at the ExxonMobil Parcel. Historical analytical data for total and/or dissolved lead are not available for the ADC Parcel or from the area to the northwest of the Property. The upgradient and downgradient extent of total lead impact cannot be inferred based on available data.



Dissolved lead has not been detected at concentrations above the MTCA Method A cleanup level of 15 µg/L in samples collected at the Property or on neighboring parcels. Dissolved lead has not been detected to the east of the Property. One groundwater sample collected in 1993 from well MW-33 had a reportable concentration of dissolved lead. However, this concentration was below the MTCA Method A cleanup level. No further work is required.

### **6.3.5 PAHs**

Groundwater analytical data for PAHs are shown on Table 7. Concentrations of cPAHs were evaluated in the context of toxicity equivalencies (WAC 173-340-708(8)(e)). The TEQs were determined assuming one-half of the method reporting limit for nondetected compounds. The historical distribution of cPAHs in groundwater is shown on Figure 52. TEQ-adjusted total cPAH concentrations exceeded the MTCA Method A cleanup level of 0.1 µg/L for water in samples collected primarily in the southern portion of the Property and to the northeast of the Property, in a line roughly corresponding to cross-section A-A'. cPAHs have not been detected in the extreme southern portion of the ExxonMobil Parcel. Historical analytical data for PAHs in groundwater are limited for the ADC Parcel and for the area west and northwest of the Property. Therefore, this is considered to be a data gap that will be addressed in the data gaps investigation.

## 7.0 CONCEPTUAL SITE MODEL AND PATHWAYS

This section presents the Conceptual Site Model (CSM) with applicable pathways and transport mechanisms based on physical characteristics of the Site. During preparation of the CSM, the following factors were taken into consideration:

- Presence of Indicator Hazardous Substances;
- Concentration of IHSs in relation to screening and other applicable criteria;
- Extent and distribution of IHSs in impacted media;
- Transport mechanisms between media;
- Potential migration to receptors;
- Properties of IHSs;
- Properties of media; and
- Potential for natural attenuation.

As discussed in Section 2.1, “Property” refers to the two contiguous parcels owned by ExxonMobil and by ADC (the ExxonMobil Parcel and the ADC Parcel, respectively). The Property and portions of neighboring parcels to the west (former ADC/General Petroleum Co. warehouse), north (Everett Avenue right-of-way up to the CSO line), and east (BNSF property and in the vicinity of the former loading racks) that are affected by hydrocarbon contamination comprise the ExxonMobil ADC Site (Ecology Facility ID 2728), as defined by MTCA (“Site”). The precise boundaries of the Site have not yet been determined. Locations within the Property boundary may be referenced as the Property or on-Property, and locations outside the Property boundaries may be referenced as off-Property.

### 7.1 Current and Future Land/Water Uses

Based on the City of Everett Comprehensive Plan, the Property and the land to the north, south, and west are zoned for Heavy Manufacturing (M-2). Zoning to the east is the Central Business District (B-3).

In 1999 as an interim action completed under the 1998 Agreed Order, ExxonMobil/ADC capped the Property with asphalt pavement. The asphalt-capped Property is currently leased to KC for employee parking. The property downgradient from the Property is currently used by the Port of Everett for storage. There is no known proposed future development of the Property; however, it is likely that the Property will remain industrial in the future. In addition the groundwater below the site will never be considered for beneficial use due to the industrial nature of the area, the closeness to salt-water intruded groundwater, the availability of a public potable water supply, and the existence of County and City regulations against use of drinking water wells.

## 7.2 Sources and Types of Contamination

Petroleum hydrocarbon impacts to soil and groundwater at the Property have resulted from past releases from former operations at the ExxonMobil and ADC Parcels. Beginning in the 1920s or earlier, the Property was used for petroleum bulk storage, transfer, and distribution operations; marine offloading; truck loading; and rail loading and/or unloading operations of petroleum products. The only identified known source of subsurface contamination is a reported spill in the southern portion of the ADC Parcel. There is also a possibility that impacts to soil and groundwater beneath the Property have resulted from off-Property sources, such as facilities located to the north and northeast of the Property (Section 2.2.2). These facilities operated as historic petroleum bulk facilities and included bulk fuel pipelines, pumping facilities, storage facilities, railroad spurs, and railroad and maritime loading facilities. The sources described above are considered primary sources of contamination. Liquid-phase hydrocarbons described in Section 6.2 are considered a secondary source of contamination.

In association with remedial actions undertaken on the Property in 1999, excavations have occurred that removed some of the identified IHS's. These activities include excavation associated with capping the Property, removal of building slabs, excavation of the firewall foundation in the northeast of the ADC Parcel and excavation of the interceptor trench located along the northern and western boundaries of the Property. A comparison of pre-cap Property site contours and finished contours (minus 2.5 feet for the capping material) was used to determine the excavated areas and depths (original and post cap contour maps can be found in Appendix B – historical maps and documentation).

In May 1988, a 45-long infiltration gallery was installed in the vicinity of MW-14. In March 1989, an automated groundwater extraction and treatment system was installed in the location of the May 1988 infiltration gallery. The system consisted of a fluid extraction sump situated in RW-1 (formerly MW-14), an oil-water separator, an air stripper, and infiltration gallery. The infiltration gallery, which was approximately 100 feet long, was constructed parallel to the north side of the ExxonMobil Parcel. In December 1993, an LPH recovery trench was installed to the west of the ExxonMobil Parcel. The trench was installed in a north-south orientation, to a depth of approximately 4 feet bgs. Soil excavated during constructions was stockpiled on the Property, covered with visqueen, and later disposed of at a permitted facility.

Petroleum-affected soils along the overcrossing alignment extended from the west side of California Street to the center portion of the KC parking lot. The contamination was found to be present generally from 4 to 5 feet bgs. The petroleum-affected soils extended over an area of approximately 25,600 square feet and on average were approximately 8 feet thick. Thus, approximately 7,600 cubic yards of petroleum-contaminated soil was calculated to be present along the overcrossing alignment (URS, 2000a). In 2002, these soils were excavated and disposed of during CSTO construction project. According to weight tickets attached to e-mail from Shawn Severn (Premier) to Bill Joyce in 2002, 207.72 tons of contaminated soil associated with CSTO construction was excavated and disposed off at Rinker facility in Everett in 2002. Soil excavation areas are shown on Figure 53.

Presently, five discreet secondary source locations are identified based on the occurrence of free product. The secondary source areas are identified on Figure 54. These areas are vertically delineated based on the deepest occurrence of contaminated soil using the boring logs to determine wood waste containing hydrocarbons or other lithologies with strong odor and/or elevated analysis result.

- Source 1 is situated in the vicinity of well W-1. Well W-1 contains free product with a maximum thickness of 4.42 feet measured in October 2005. In addition, a soil sample that was collected from W-1 at the depth of 3 feet bgs, had 13,000 mg/kg of undifferentiated TPH concentration. Soil contamination to the west of W-1 is delineated by the interceptor trench with no measurable free product noted in the closest recovery wells LPH3 and LPH4. To the east and north high concentrations of TPH were detected in AD-13, AD-14 and AD-10 (boring locations are shown on Figure 22) prior to the placement of the site cap in 1999. These high concentrations would have been removed during the work in 1999, when building slab removal (an office building, oil pump house building, a warehouse, and boiler room, aboveground piping, loading racks) and general excavation occurred. Soil contamination will be verified during the data gap investigations by continuous sampling from 0 to 5 feet of a deep boring to be advanced in the vicinity of AD-10 and AD-11. The lateral extent of Source 1 to the west, south, east, and north is limited to the vicinity of W-1.
- Source 2 is situated in the vicinity of well W-2 and extents laterally towards the northeast. Well W-2 has had frequent trace occurrence of free product. In addition, a soil sample that was collected from W-2 at the depth of 3 feet bgs, had 17,000 mg/kg of undifferentiated TPH concentration.
- Source 3 is limited to the vicinity of well W-10R. Well W-10R inclusive of LPH6 has had frequent occurrence of free product. The lateral extent of Source 3 to the east is defined by TPH concentration below MTCA Method A cleanup level reported in shallow soil sample collected from AD-4. The lateral extent of Source 3 to the west and north is bound by the LPH recovery trench and the firewall foundation. Source 3 lateral extent to the south will be assessed during the data gap investigations with continuous sampling from 0 to 5 feet of a deep boring to be advanced in the vicinity of LPH5.
- Source 4 is situated in the vicinity of former boring B-21-91 where an undifferentiated TPH concentration of 12,000 mg/kg was reported in a soil sample collected from boring B-21-91 at 5 feet bgs. Source 4 extends north towards wells W-17 and LPH9. Both wells have had frequent trace to measurable thickness occurrence of free product. Source 4 does not extend beyond the northern property boundary because no TPH-D and TPH-O above MTCA A cleanup levels were reported in soil samples collected from GP-4 and GP-5. In 1999, the northeast portion of the firewall that was surrounding the former tank farm at the ADC parcel was demolished prior constructing to the cap. The foundation of the firewall in the northeast corner was excavated to the depth of 7 feet bgs (Exponent 2000). This excavation is considered to be the eastern extent of Source 4 and will be verified during the data gaps investigation.

- Source 5 is situated in the vicinity of wells MW-27 and MW-29. The combined area surrounding MW-27 and MW-29 span significant occurrence of wood waste. Both wells have frequent occurrence of free product. The southern extent of Source 5 is unknown and will be assessed during the data gap investigations.

There are no secondary sources of contamination within the ExxonMobil Parcel due to extensive excavation activities on the Parcel and the surrounding properties to the west, east, and south (Figure 53).

### **7.3 Contaminant Migration Pathways/Media of Potential Concern**

This section summarizes applicable transport mechanisms for each affected medium of concern.

#### **7.3.1 Soil**

Since the Property is capped, there are two potential transport mechanisms from soil—soil to groundwater, and soil to vapor. Leaching (including infiltration and percolation) can transport soil particles and solubilized constituents to groundwater. The primary area of concern on the site for transport of soil to groundwater is related to the secondary source areas (Figure 54).

Similarly, volatilization of chemicals from soil directly to vapor may allow contaminants to be transported from soil to air. In addition, should the cap be damaged or removed there would be a potential for direct contaminant transport from soil to storm water, surface water, and sediment. Therefore, soil at the Property is a medium of concern. Additionally, paving outside the Property boundary is beyond ExxonMobil's control, so transport mechanisms from soil for the remainder of the Site (outside the Property) should also be considered.

#### **7.3.2 Groundwater**

There are two potential mechanisms for transport of contaminants from groundwater – groundwater to vapor and groundwater to surface water. Volatilization of chemicals directly from groundwater to vapor is considered viable. Groundwater can potentially migrate off-Property to Port Gardner Bay. Groundwater migration to the CSO line was observed and mitigated in 1996. Due to extensive repairs to the CSO line made in 1996, subsequent migration of groundwater to the CSO is unlikely. Groundwater that migrates to surface water could also impact sediment via sorption directly from groundwater or from porewater as a result of groundwater flux to surface water. Therefore, groundwater is a medium of concern. At this time, migration of IHSs from groundwater to surface water has not been shown to be occurring although more data is required to confirm this.

#### **7.3.3 Vapor**

No potential transport mechanisms from vapor were determined. The vapor phase is considered a terminal endpoint of impact—not a primary source of contaminants to other media. Vapors were evaluated as emanating from other affected media, such as soil and groundwater. Therefore, vapor is not a medium of concern.

### **7.3.4 Stormwater**

No potential transport mechanisms from stormwater were identified. The surface of the Property is capped, and stormwater sheet flows to the catch basins located at the Property and downgradient from the Property. The stormwater system at the Property was video surveyed in 2007, and no breaches or infiltration were observed in the system. Therefore, there is no pathway from soil or groundwater to stormwater, and stormwater is not a medium of concern. However, stormwater has not been shown to have impacts from the Site, so this is an incomplete pathway.

### **7.3.5 Surface Water**

Surface water bodies (e.g. Port Gardner Bay) are considered a terminal endpoint of impact and not a primary source of contaminants to other media. Surface water is a medium of concern due to its status as a terminal endpoint. Surface water transport off the Property is not considered a pathway since the Property is capped with asphalt pavement. Stormwater from the Property discharges to the CSO, which has been reconstructed to eliminate potential contact to affected groundwater. The only pathway to surface water currently is a potential pathway of groundwater to Port Gardner Bay. At this time the completeness of this pathway is not known since the extent of groundwater impacted above screening levels is not fully delineated to the west.

### **7.3.6 Sediment**

No potential transport mechanisms from sediment exist. Sediments are considered a potential terminal endpoint of impact and not a primary source of contaminants to other media. No direct releases from the Property to sediment have been documented, and this transport mechanism is considered not to be a primary source. However, at this time the completeness of this pathway is not known since the extent of groundwater impacted above screening levels is not fully delineated to the west.

## **7.4 Indicator Hazardous Substances**

Under MTCA, “indicator hazardous substances” means the subset of hazardous substances present at the Site that constitute the basis for monitoring and analyses, or the basis for any phase of remedial action for the purpose of characterizing the Site or establishing cleanup requirements for the Site. Consistent with WAC 173-340-703, when defining cleanup requirements at a Site contaminated with a relatively large number of detected chemicals of concern, Ecology might eliminate from consideration those hazardous substances that contribute a small percentage of overall threat to human health and the environment. Historically, TPH-D, TPH-O, TPH-G, benzene, toluene, ethylbenzene, xylenes, PAHs, and lead were found in soil and groundwater at the Property.

The statistical summaries for soil and groundwater results are presented in Tables 8 and Table 9, respectively. The summaries present the number of samples analyzed, the frequency of detection, the minimum and maximum detection limits, the minimum and maximum results, the mean result for each chemical, the number of results that exceed MTCA Method A or MTCA

Method B cleanup levels, and whether or not the chemical is selected as an indicator hazardous substance.

#### **7.4.1 Soil**

The Property and its immediate surroundings are zoned for industrial use. The Property is covered by a low-permeability asphalt/concrete cap. Soils at the Property consist of fill overlying recent marshland and transitional beds deposited between Fraser and pre-Fraser glaciations. Heterogeneous mixtures of sands, silts, peat, and wood debris extend to depths of 20 to 27 feet bgs. A discontinuous organic silt/clay unit and a dense, moist, brown, medium sand unit were encountered at greater depths in borings that were advanced to depths greater than 20 feet bgs.

With the asphalt cap on the Property, the potential exposure routes and receptors are limited to:

- Contact (dermal, incidental ingestion, or inhalation) with hazardous substances in soil by construction workers;
- Partitioning of hazardous substances in soil to groundwater.

It is assumed at this point that the cap on the property will either remain in place as part of the final remedy or the soil will be addressed.

Constituents detected in the upper 15 feet of soil were evaluated to assess the potential risk to humans, plants, and small animals posed by contaminated soil. These exceedances appear to be mostly limited to the fill material beneath the Property. In addition, soil concentrations considered protective of terrestrial receptors (plants and animals) were assessed using a simplified terrestrial ecological evaluation (WAC 173-340-7492). A copy of the evaluation is presented in Appendix E. According to the simplified terrestrial ecological evaluation, the Site does not have a substantial potential for posing a threat of significant adverse effects to terrestrial ecological receptors. Thus, ecological receptors will be removed from further consideration during development of cleanup levels.

As shown in Table 8, the following chemicals have been detected in soil samples collected at the Site:

- TPH-D has been detected at concentrations above the MTCA Method A cleanup level of 2,000 mg/kg at the Property and to the north, west, and east (Figures 22 through 25). The majority of the samples with TPH concentrations above the MTCA Method A cleanup level were collected at shallow depths (less than 5 feet bgs). However, soil samples with exceedances of TPH were collected at depths of 7.5 feet bgs and greater in several borings. TPH-D and TPH-O were selected as indicator hazardous substances.
- TPH-G was not detected at concentrations above 30 mg/kg (MTCA Method A cleanup level if benzene is present) in soil samples collected to the south and southwest of the Property, but was detected at concentrations greater than 100 mg/kg in soil samples collected to the north, west, and east of the Site (Figures 26 to 29). Samples collected

on the Property were not analyzed for TPH-G. TPH-G was selected as an indicator hazardous substance.

- Concentrations of benzene above the MTCA Method A cleanup level of 0.03 mg/kg were reported for soil samples collected on- and off-Property (Figures 30 through 33). Samples containing concentrations of benzene greater than 0.03 mg/kg have been collected from three general areas: the center of the ExxonMobil Parcel; off-Property to the east; and one location off-Property to the west (MW-A2) (Figure 30). Benzene was selected as an indicator hazardous substance due to the potential risk to humans, plants, and small animals. Concentrations of ethylbenzene and total xylenes have also been detected above the MTCA Method A cleanup levels (Figures 35 and 36). However, these constituents are associated with benzene, which has already been identified as a hazardous indicator substance, so none of these constituents by itself was selected as an indicator hazardous substance.
- Soil samples collected on the Property and to the west, north, and east of the Property did not contain lead at concentrations above the MTCA Method A cleanup level for industrial land use (1,000 mg/kg) (Figures 37 through 40). Lead was not selected as an indicator hazardous substance.
- Samples collected on the Property have not been analyzed for PAHs. However, toxicity-equivalent concentrations of total cPAHs were reported below MTCA Method A industrial cleanup levels but above MTCA Method A cleanup levels for unrestricted use in four soil samples collected off-Property to the north and to the south (Figures 41 and 42). Three soil samples contained benzo(a)pyrene at a concentration above the MTCA Method A residential cleanup level of 0.1 mg/kg. Thus, cPAHs were selected as indicator hazardous substances.

#### **7.4.2 Groundwater**

Groundwater beneath the Site is not currently used as a drinking water source nor is it likely to be considered a drinking water (potable) source in the future as discussed earlier. However, preliminary screening criteria currently used for the Site assume the highest potential beneficial use, which is as a potential source of drinking water.

WAC 173-340-720(2)(c) and (d) provides that even if groundwater is classified as a potential future drinking water source, Ecology recognizes there are sites for which a very low probability exists that the groundwater would be used as a drinking water supply, owing to the proximity of surface water that is unsuitable for use as a domestic supply. The Site's groundwater is in direct proximity to a surface water body not suitable as a potable water supply (Port Gardner Bay). There are no known water supply wells within one-half mile of the Site, and the groundwater does not serve as a current source for drinking water. Neither the Site nor the Port Gardner Bay surface water is hydraulically connected to a future source of groundwater that may be used as a domestic drinking water supply.

The top of the saturated zone is situated within fill materials at approximate depths ranging from 1 to 5 feet bgs. Previous groundwater elevation data indicate fluctuations of up to 3 feet



between high and low seasonal water tables. Based on the historical groundwater elevation data, groundwater beneath the Property flows generally toward the west and northwest. Most likely, the groundwater table is higher currently than in the past due to infill of the coastline to the west of the Property. Groundwater levels gauged in monitoring wells constructed at the Site do not appear to be significantly affected by tidal fluctuations, however, the recent tidal study results were inconclusive to determine the exact tidal influence.

Analytical data from groundwater samples were compared to groundwater cleanup levels protective of human health. The screening levels selected are MTCA Method A unrestricted use cleanup levels, if available. MTCA Method B cleanup levels were used for IHSs for which no Method A cleanup level exists. The groundwater analytical results indicate the following constituents are present in groundwater beneath the Site.

- TPH-D and/or undifferentiated TPH has been detected at concentrations above the MTCA Method A cleanup levels throughout the Site (Figure 44). Therefore, TPH-D was selected as an indicator hazardous substance.
- TPH-G has been detected at concentrations above the MTCA Method A cleanup levels in groundwater samples collected from the monitoring wells installed at the Property as well as monitoring wells installed to the east and northeast of the Property (Figure 45). Therefore, TPH-G was selected as an indicator hazardous substance.
- Benzene has been detected in groundwater samples collected on- and off-Property at concentrations above the MTCA Method A cleanup levels (Figure 46). Therefore, benzene was selected as an indicator hazardous substance. Toluene, ethylbenzene, and total xylenes have also been detected in groundwater samples collected on- and off-Property (Figures 47, 48, and 49, respectively). No samples contained toluene and ethylbenzene at concentrations above the Method A cleanup levels (Figures 47 and 48). Only two samples collected from MW-15 and MW-18 in 1988 contained total xylenes at concentrations exceeding the MTCA Method A cleanup level (Figure 49). Since toluene, ethylbenzene, and total xylenes are not exceeding Method A unrestricted cleanup levels, with the exception of total xylene detections reported in two samples in 1988, those constituents in groundwater do not pose a risk to humans. None of these constituents was selected as an indicator hazardous substance.
- Total lead has been detected at concentrations above the MTCA Method A cleanup level in groundwater samples collected at the Site (Figure 50). Increased turbidity in groundwater samples may be attributed to soil lithology, increased organic content, screen size, and/or purging. High concentrations of total lead occurring in groundwater samples at the Site are most likely due to increased organic content in the formation being sampled. Due to the high turbidity of groundwater samples, total lead results in groundwater are not representative of groundwater quality due to the contribution of lead contained in suspended sediment. Dissolved lead has not been detected at concentrations above the MTCA Method A cleanup level in groundwater samples collected at the Site (Figure 51). Therefore, lead was not selected as an indicator hazardous substance.

- cPAHs have been detected at toxicity-equivalent adjusted concentrations above the MTCA Method A cleanup level in groundwater samples collected at the Site (Figure 52). Therefore, cPAHs were selected as indicator hazardous substances.

## **7.5 Potential Receptors and Exposure Pathways**

In this section, potential exposure pathways are evaluated to assess whether complete pathways exist that could pose a threat to potential receptors. Soils are hydrologically linked to groundwater and surface water systems. One of the objectives of soil remediation at the Site is to manage soil-to-groundwater pathways to prevent unacceptable transfer of contaminants from the soil, which may ultimately affect groundwater and potential surface water use. This section identifies the locations and environmental media (soil and groundwater) at the Site that require cleanup action evaluation in the FFS.

### **7.5.1 Potential Receptors**

Human receptors are the most sensitive receptors to the IHSs under current and likely future land uses. The entire range of activities associated with land use at the Site, on-Property, and off-Property, must be free of appreciable health risks. Potential human receptors are the general public, Kimberly-Clark workers, and future construction workers.

For the Property, ecological receptors are not considered to be present due to the lack of any habitat. Since there remains a potential pathway of groundwater to Port Gardner Bay, there could be potential ecological receptors such as marine life and birds; however, at this time it is not known if Site-affected groundwater has migrated to Port Gardner Bay at concentrations above screening levels. Further data will be collected to delineate the extent of groundwater impacts as part of the FFS work, and this information will determine if ecological receptors need to be further evaluated.

### **7.5.2 Potential Exposure Pathways**

Potential exposure pathways for the public, general workers and construction workers for each medium were evaluated. A descriptive summary of this evaluation is provided below.

#### **7.5.2.1 SOIL**

The Property is covered with a low-permeability asphalt surface cap that prevents direct contact with the underlying soil. Therefore, the pathway is currently incomplete for direct exposure to contaminants in soil at the Property by the general public and general workers for the current site use.

Exposure to soil by construction workers via dermal absorption, ingestion, and/or inhalation as a result of subsurface excavation is a potential exposure pathway. This potential exposure pathway will be addressed in the FFS.

### 7.5.2.2 GROUNDWATER

The Property is currently covered with a low-permeability asphalt surface cap, which prevents direct contact with the underlying groundwater and minimizes infiltration of surface water. Therefore, the pathway is incomplete for direct exposure to contaminants in groundwater at the Site by the general public and general workers. In addition, groundwater beneath the Site is not currently used as a drinking water source nor is it likely to be considered a drinking water (potable) source in the future.

As noted in Section 7.3.2, there is a potential pathway of contaminants from groundwater to surface water (Port Gardner Bay). Potential exposure of receptors to surface water impacted by contaminant transport from groundwater will be addressed in the FFS.

### 7.5.2.3 STORM WATER

Storm water on the Property drains to storm drains that are connected to a combined sewer. Water entering these storm drains is conveyed to the City of Everett sewage treatment plant. This pathway is considered complete; however, the potential is low for direct exposure to contaminants in storm water at the Site by the general public and general workers.

### 7.5.2.4 SOIL AND GROUNDWATER TO VAPOR

The Property is currently covered with an asphalt cap that limits vapor migration from soil. Since the cap limits but does not eliminate vapor migration, the pathway remains complete; however, the potential is low for exposure by general workers to contaminants transported to vapor from soil or groundwater at the Property. Exposure to vapor by construction workers at the Site will be addressed in the FFS.

### 7.5.2.5 GROUNDWATER TO SURFACE WATER

There remains a complete pathway of groundwater to Port Gardner Bay, although data will be obtained as part of the FFS work to evaluate whether groundwater is migrating to the Bay at concentrations above ultimate cleanup levels. It is also noted that groundwater that actually migrates to surface water could also impact sediment via sorption directly from groundwater or from porewater as a result of groundwater flux to surface water. Depending on the results of the groundwater delineation, aquatic organisms and terrestrial organisms in the Bay may be potential receptors of contaminants in groundwater and may need to be evaluated in the FFS. The risk of exposure to contaminants in surface water is low for general workers and construction workers.

The risk of exposure to contaminants in surface water by potential receptors will be addressed in the FFS.

## 7.6 Overview of Site Conditions

An overview of the secondary source areas and the extent of groundwater impacted at concentrations above screening levels at the Site is presented in Figure 54. LPH is located primarily in the area northeast of the Property boundary in the vicinity of MW-27 and MW-29.

Sporadic occurrences of LPH have been observed in the southern portion and on the western border of the Property. During exploration, LPH has been primarily associated with wood debris. Elevated concentrations of TPH-D, TPH-G, and benzene in soil have also been noted in the vicinity of the LPH. Concentrations of PAHs, cPAHS, lead, toluene, ethylbenzene, and xylenes in soil are not elevated. There is no observed downgradient migration of gasoline or benzene in the dissolved phase. Dissolved-phase concentrations of diesel have been observed downgradient of the Property and will be delineated as part of the data gaps work and addressed in the FFS.

## 8.0 FOCUSED FEASIBILITY STUDY

This section summarizes the general approach to completing the FFS. Remaining data gaps will be addressed by conducting additional remedial field investigations. Prior to field investigations, appropriate start cards will be obtained from the Ecology Water Resources Program to install monitoring wells. Details of the approach to completing the FFS will be developed based on results of the data gaps investigation.

The investigation of the data gaps described in Section 8.1 is addressed in the SAP, included as Appendix A of this Work Plan. The SAP constitutes a work plan for all drilling, sampling, and other investigative activities to be conducted for the FFS. A schedule of the proposed activities and reporting timelines is provided in Appendix G.

### 8.1 Data Gaps and Supplemental Field Investigations

The Property and neighboring parcels have been the subject of extensive subsurface investigations to characterize the nature and extent of impacts to soil and groundwater from hydrocarbon releases at the Property. The next step to complete the FFS is to complete the characterization of the nature and extent of soil and groundwater contamination resulting from releases at the Property and select a final remedial approach to address the historic releases.

Five areas of affected soil and groundwater at the Site are illustrated on Figure 54. As detailed in Section 7.0, AMEC has identified certain data gaps to complete the FFS. These data gaps and the proposed supplemental field investigations to complete these data gaps are described below. The proposed field investigations are summarized on Figure 55.

#### ***8.1.1 Extent of TPH-D, TPH-O, and TPH-G Impacts in Groundwater***

TPH-D, TPH-O, and TPH-G have been observed in the dissolved phase in groundwater beyond the perimeter of the Property boundary. The western, northwestern and northeastern limits of the dissolved-phase plume are not fully defined. In addition, the potential presence of a dissolved-phase plume associated with the ADC Garage and Shop formerly located across Federal Avenue from the Property is unknown.

To address the data gap, four groundwater monitoring wells (MW-A3 through MW-A6) will be installed to depths of less than 20 feet bgs between Port Gardner Bay and the Property, and one groundwater monitoring well (MW-A7 [deep]) will be installed upgradient of the Property (Figure 55). In addition, one grab groundwater sample will be collected from boring AP-1 located in the former ADC Garage and Shop. The wells will aid in defining the limits of petroleum-impacted groundwater. During drilling, soil samples will be collected for analyses of petroleum hydrocarbons to evaluate whether additional petroleum hydrocarbon sources are contributing to the existing plume.

### **8.1.2 Nature of Aquitard Below Property**

Containment as an appropriate strategy will be evaluated to address the hydrocarbon source area. The silt/clay unit that underlies the Property may serve as an aquitard, but past investigations have provided inconsistent information related to the description, depth, and continuity of the layer.

To address this data gap, six deep soil borings (AB-1 through AB-6) will be advanced around the perimeter of the Property to maximum depths of 35 feet bgs to assist in evaluating the lateral extent of the aquitard. In addition, an additional deep boring will be advanced to the east of MW-29. The deep boring will be backfilled and completed as a 2-inch-diameter monitoring well (MW-A7) screened from 3 to 13 feet bgs. As part of this investigation, soil samples will be collected and tested for physical geotechnical properties as needed for design purposes.

### **8.1.3 Extent of Soil Impacts Surrounding ADC Parcel**

To evaluate the limits of any proposed excavation the extent of impacts to soil should be thoroughly characterized. The precise vertical and horizontal extent of hydrocarbon impacts in soil in the area east of the northern portion of the ADC Parcel needs to be assessed to accurately determine the extent and volume of potentially impacted soil. According to the boring log for MW-29, contaminated soil was detected by field screening at a depth of 9 feet bgs in MW-29, but no samples were collected for chemical analyses from depths greater than 2 feet bgs in this boring or nearby locations MW-27, MW-28, and MW-30. LPH was historically present in monitoring well MW-29. Characterizing the vertical and horizontal extent of soil impacts in the vicinity of MW-29 will better quantify the extent of affected soil and support a practicability analysis for remedial alternatives pursuant to MTCA.

To address this data gap, six soil borings (AP-2 through AP-7) will be advanced in the area east of the northern portion of the ADC Parcel (near former General Petroleum Corporation's spur fuel loading rack) to a maximum depth of 15 feet bgs to define the lateral and vertical extent of soil contamination in the vicinity of MW-29. In addition, the additional deep boring advanced to the east of MW-29 to evaluate the containment option for the hydrocarbon source areas (Section 8.1.2) will provide additional information about soil impacts in this area. The deep boring will be backfilled and completed as a 2-inch-diameter monitoring well (MW-A7) screened from 3 to 13 feet bgs.

In addition, four of the six deep soil borings (AB-1, AB-2, AB-5, and AB-6) will be advanced around the perimeter of the Property to assist in evaluating the lateral extent of the secondary source areas 1, 2, and 4 (Section 7.2). Soil samples from borings AB-1 and AB-5 will be collected continuously from approximately 0.5 to 5 feet bgs. Shallow samples (above water table) with the obvious signs of petroleum-hydrocarbon contamination will be analyzed for TPH-D and TPH-O.

### **8.1.4 Tidal Influences**

Minimal groundwater response to tidal fluctuations has been observed during previous investigations.

The potential for tidal influences on groundwater will be evaluated further by undertaking a tidal study incorporating a temporary stilling well in Puget Sound as well as newly installed and existing groundwater monitoring wells.

#### ***8.1.5 Extent of Ongoing Natural Attenuation***

Natural attenuation appears to be occurring in areas affected by releases from the Property based on the presence of dissolved-phase petroleum hydrocarbons in groundwater. It is not known whether natural attenuation processes are successfully reducing concentrations of hydrocarbons to below preliminary screening levels in the downgradient plume. The rate of degradation within the plume is also unknown.

To assess the rate of natural attenuation, groundwater samples will be collected from wells within the downgradient plume and analyzed for a suite of natural attenuation parameters. The groundwater sampling will be designed so as to collect samples representative of separate wet and dry seasons. Analyses will include general chemistry water quality parameters (i.e., dissolved oxygen, total organic carbon, alkalinity, etc.). The selection of natural attenuation parameters will be consistent with requirements specified in Ecology guidance (Ecology 2005).

#### ***8.1.6 Aquifer Properties***

To determine the hydraulic conductivity of off-Property aquifer materials, aquifer testing will be performed. The aquifer testing will be performed by conducting slug tests in two of the downgradient monitoring wells installed as part of this Data Gaps Supplemental Investigation.

#### ***8.1.7 Analytical Testing***

Two soil samples collected from each soil boring installed as part of this Supplemental Investigation will be analyzed for TPH-G, TPH-D, and TPH-O using Ecology methods NWTPH-Gx and NWTPH-Dx; samples with detectable concentrations of TPH-D will be run with a silica gel cleanup to remove any biogenic interference (typically from decaying plant matter).

Soil samples from the downgradient borings (MW-A3 through MW-A6 and AP-1) will be analyzed for BTEX and methyl tertiary-butyl ether (MTBE) using EPA Method 8260B, and low-level PAHs by EPA method 8270D SIM. In addition, select soil samples from these downgradient borings that exhibit contamination based on field screening will be analyzed for 1,2-dichloroethane, ethylene dibromide (dibromoethane), and n-hexane by EPA Method 8260B.

Two soil samples with the highest concentration of detected petroleum hydrocarbons will be analyzed for extractable petroleum hydrocarbons (EPH) and volatile petroleum hydrocarbons (VPH) using Ecology Method WA MTCA-EPH/VPH. The soil sample results will assist in defining the horizontal and vertical extent of soil contamination with IHS. Results of EPH/VPH analyses will be used in calculating remediation levels during the FFS.

Two soil samples collected from the saturated zone of the perimeter borings (AB-1 though AB-6) will be analyzed for total organic carbon, soil bulk density, porosity, volumetric water content, and permeability (Shelby tube). Samples of drill cuttings will be retained from each

boring for use in developing design parameters for a potential slurry wall mix, if necessary. Data from this testing will be used to assist in the development of remedial alternatives.

Groundwater monitoring will be conducted at the Site after the additional wells are installed. The groundwater samples will be collected from five existing wells (MW-11, MW-19, MW40R, MW-A1 and MW-A2) that are currently monitored semiannually, four newly installed downgradient monitoring wells (MW-A3 through MW-A6), and one newly installed upgradient monitoring well (MW-A7). The quarterly groundwater samples will be analyzed for TPH-G, TPH-D, and TPH-O using Ecology Methods NWTPH-Gx and NWTPH-Dx; BTEX and MTBE by EPA Method 8260B; low-level PAHs by EPA method 8270D SIM; and dissolved lead by EPA Method 6020. In addition, selected groundwater samples will be analyzed for 1,2-dichloroethane, ethylene dibromide and n-hexane by EPA Method 8260B. As previously mentioned, groundwater samples will be collected during the dry season and wet season quarterly groundwater monitoring events for analysis of natural attenuation parameters.

## **8.2 General Approach to Focused Feasibility Study**

After the Data Gap Supplemental Investigation has been completed and at least one groundwater monitoring event that incorporates the newly installed wells has been conducted, the FFS will be performed. The purpose of the FFS is to identify and evaluate remedial alternatives for the contaminated subsurface soil to minimize or prevent further releases of pollutants into the groundwater and reduce the off-site migration of contaminated groundwater.

In advance of the FFS report the Remedial Action Objectives have been identified. The RAOs are site-specific goals established to protect human health and the environment. The RAOs provide a framework for developing and evaluating remedial action technologies and alternatives. Three preliminarily RAOs have been identified for the FFS.

- Reduce the potential for IHSs to leach from site soil to groundwater.
- Reduce the potential for IHSs to migrate off site.
- Meet cleanup levels in soil and groundwater at the applicable point of compliance within a reasonable restoration time frame.

Groundwater and soil are the two primary media that will require remedial action. The objective will be to address the remaining exposure pathways/receptors and this can be achieved by reducing concentrations and contaminant mass in soil (source control) which therefore, will address the soil to groundwater pathway and the vapor pathway. Institutional controls will be evaluated to address the remaining direct exposure pathway.

MTCA requires that cleanup levels be met at the point of compliance or at a conditional point of compliance. MTCA (WAC 173-340-720 through 173-340-760) defines development of cleanup levels for groundwater and soil and outlines the process for determining the point of compliance or conditional point of compliance (WAC 173-340-720(8)(c) for each medium. A conditional point of compliance can be at the Property boundary or beyond for sites adjacent to surface



water assuming that all property owners beyond the Property agree to the conditional point of compliance.

MTCA acknowledges that cleanup levels may not be met at the point of compliance initially but requires that cleanup levels be met within a reasonable time frame [WAC 173-340-360 (4)]. MTCA also allows the use of “remediation levels” [WAC 173-340-360 (2)(h)] for sites where cleanup levels cannot necessarily be achieved at the point of compliance or where a more permanent solution is not practical based in part on MTCA’s disproportionate cost analysis.

Based on the historical data and the data obtained during the Data Gap Supplemental Investigation, the FFS will:

- Finalize Remedial Action Objectives;
- Establish site-specific cleanup levels, points of compliance for soil and groundwater, and, if necessary, propose remediation levels;
- Identify applicable state and federal laws;
- Evaluate Cleanup Alternatives based on MTCA criteria (WAC 173-340-360), including threshold requirements, permanency of remedial solutions, restoration time frame, public concerns, and cost, including procedures to assess relative benefits versus disproportionate cost; and
- Recommend a Remedial Action Alternative.

The FFS will also present an expected schedule of implementation and a public participation plan.

### ***8.2.1 Review of Potential Remedial Alternatives***

A reasonable number and type of cleanup action alternatives have been previously evaluated in an earlier report (Exponent, 1998a). Based on the previous work and discussion with Ecology, the FFS will not redo the screening of technologies section of the previously approved Feasibility Study (FS). Instead, the FFS will proceed directly to the evaluation of feasible remediation alternatives. Consistent with discussions and meeting with Ecology, the FFS will focus on evaluating a select number of remediation alternatives that are considered potentially feasible to address petroleum hydrocarbon impacts in soil and groundwater at the Site. These remediation alternatives include:

1. Excavation of secondary source area to the degree practicable, capping of soils, and monitored natural attenuation to address downgradient groundwater;
2. Capping of the source area to contain site soils and Monitored Natural Attenuation to address downgradient groundwater;
3. Subsurface slurry wall containment barrier and capping of the source area and monitored natural attenuation to address downgradient groundwater; and

4. Enhanced natural attenuation through the use of an oxygen enhancer for downgradient groundwater.

The combinations of two or several remediation alternatives listed above are considered potentially appropriate to address hydrocarbon impacts along with the use of Institutional Controls at the Site. These alternatives will be evaluated in the FFS as standalone cleanup options. The alternatives consist of technologies or combination of technologies to address the source area soils and LPH, combined with one or two technologies to address downgradient groundwater.

The remediation technologies employed in these alternatives are described below.

#### EXCAVATION OF SECONDARY SOURCE MATERIAL

Remedial excavation involves excavation, transport, and off-site disposal of affected soil. Impacted soil could be removed based on assumptions specific to each of three options: (1) "secondary source area" removal, (2) removal of known source(s), and (3) comprehensive excavation. The limits of practicable soil removal will be evaluated in the FFS in accordance with MTCA's permanence criteria.

#### SLURRY WALL

A subsurface slurry barrier wall is a relatively narrow (6 inches to 3 feet thick), subsurface, low-permeability barrier wall that is installed using slurry-trenching technology. The wall is designed to impede groundwater flow and eliminate the potential migration of LPH. A slurry wall would be used in conjunction with a remediation system to address impacted soil and/or groundwater. A slurry wall would likely be constructed by mixing native soils with bentonite clay and possibly other admixtures in situ in an alignment partially surrounding the source area. The slurry wall would ideally be constructed such that the bottom of the wall is keyed to an aquitard; however, a "hanging" slurry wall, in which the bottom of the wall is in the aquifer at an appropriate depth below impacted material, may be acceptable, particularly to contain LPH. If the slurry wall is considered as one of the remedial options, groundwater wells will be installed with screens below the bottom of the slurry wall on and off-property to monitor the groundwater quality.

Geotechnical data necessary to design a slurry wall include lithologic descriptions at regular intervals; depth to an aquitard; permeability of the native material at the proposed bottom of the slurry wall; and suitability of the native material as aggregate. These data will be collected during the Data Gap Supplemental Investigation.

#### MONITORED NATURAL ATTENUATION

Monitored natural attenuation (MNA) is a remedial technology that can lead to permanent destruction of IHSs in a noninvasive manner. The approach relies on natural processes, including biodegradation by indigenous organisms and adsorption to soil, to retard and degrade organic compounds and to retard and immobilize metals in combination with appropriate monitoring. Ecology allows the use of MNA only in conjunction with source removal or control. This technology is especially appropriate to the petroleum hydrocarbon plume at the Site. The

depositional history of the shallow subsurface in the vicinity of the Property has resulted in a substantial amount of natural organic materials in the subsurface. This organic material supports natural microorganisms that can support natural biodegradation of groundwater constituents. The high organic content of soils at the Site is expected to provide a favorable environment for effective natural biodegradation of organic constituents that may be present in affected groundwater.

A monitoring network and program are typically associated with this technology to ensure that hazardous constituent degradation is effective and that cleanup levels are attained. Guidance by Ecology (July 2005) provides technical recommendations regarding the types of monitoring parameters and analyses useful for evaluating the effectiveness of MNA and will be used during data gaps sampling to determine the viability of this approach for the FFS.

## OXYGEN ENHANCED BIOREMEDIATION

MNA in some cases may not result in degradation of IHAs that meet cleanup levels or meet cleanup levels in an acceptable time frame. In these cases it may be necessary to enhance the natural biodegradation processes. Since hydrocarbon compounds degrade most quickly by aerobic processes, groundwater needs to be well oxygenated to maximize biodegradation. Where groundwater dissolved oxygen (DO) concentrations are too low, at some sites the addition of air or oxygen to the groundwater can increase the DO and thereby enhance the natural processes. A common means of increases the oxygen content of groundwater is to use a manufactured time release electron acceptor, for example a magnesium peroxide-based powder that slowly releases oxygen when hydrated. This slow release of oxygen is intended to increase the DO concentration in groundwater, facilitating conditions favorable to microbes that consume contaminants such as diesel-range hydrocarbons. Such products can be applied in three ways: (1) by injection into the aquifer in slurry form, typically through direct-push points; (2) by placing a bag (“sock”) containing the product in an existing well; and (3) by mixing the product into soil in an excavation.

Data necessary to determine applicability of a time release electron acceptor and an application regime are specified by the supplier. Typical parameters of interest in addition to contaminant concentrations include pH, total organic carbon, and temperature. These data can be collected during sampling of existing wells. The potential effectiveness of this remedial technology will be evaluated in the Focused Feasibility Study.

### **8.2.2 Contents of FFS**

A proposed table of contents for the FFS is presented below.

- 1.0 INTRODUCTION
  - 1.1 Overview
  - 1.2 Purpose and Scope of Work
  - 1.3 Report Organization
- 2.0 BACKGROUND

- 2.1 Site Description and History
- 2.2 Nature and Extent of Contamination
  - 2.2.1 Geology
  - 2.2.2 Hydrogeology
  - 2.2.3 Nature and Extent of Contamination
- 2.3 Beneficial Water and Land Use
- 2.4 MTCA Risk-Based Evaluation (a list of potential applicable or relevant and appropriate requirements is provide in Appendix H).
- 2.5 Ecological Setting and Terrestrial Ecological Evaluation
- 3.0 FEASIBILITY STUDY SCOPING
  - 3.1 Remedial Action Objectives
  - 3.2 Regulatory Requirements
    - 3.2.1 Ecology Requirements
    - 3.2.2 Applicable or Relevant and Appropriate Requirements
    - 3.2.3 Permits
  - 3.3 Cleanup Levels
    - 3.3.1 Indicator Hazardous Substances
    - 3.3.2 Site-Specific Cleanup Levels
    - 3.3.3 Remediation Levels
  - 3.4 Points of Compliance
  - 3.5 Areas Needing Remediation
- 4.0 CLEANUP ALTERNATIVES
  - 4.1 Capping with Monitored Natural Attenuation
  - 4.2 Slurry Wall Containment and Capping with Monitored Natural Attenuation
  - 4.3 Secondary Source Excavation and Capping with Monitored Natural Attenuation
  - 4.4 Expanded Excavation in Accordance with MTCA's Permanence Criteria
  - 4.5 Enhanced Natural Attenuation Using *Enhanced Aerobic Bioremediation*.
  - 4.6 Institutional Controls
- 5.0 DETAILED EVALUATION OF CLEANUP ACTION ALTERNATIVES
  - 5.1 Evaluation Criteria
    - 5.1.1 MTCA Threshold Requirements
    - 5.1.2 MTCA Disproportionate Cost Analysis
  - 5.2 Individual Analysis of Alternatives
  - 5.3 Comparative Analysis of Alternatives
  - 5.4 Summary Analysis of Alternatives
- 6.0 Recommended Remedial Action Alternative

REFERENCES

LIMITATIONS

Appendix A Cost Estimates for FFS Remediation Alternatives

## 9.0 REFERENCES

- AGRA (AGRA Earth & Environmental, Inc.). 1996a. "Work Plan for Liquid Petroleum Hydrocarbon Recovery Pilot Testing", Mobil Oil Corporation and American Distributing Bulk Plants, Everett, Washington. January (revised in March).
- . 1996b. Groundwater Monitoring and Sampling Report. Mobil Oil Corporation and American Distributing Company Facilities, Everett, Washington, April 4.
- . 1996c. "Off-Site Characterization Work Plan". Mobil Oil Corporation and American Distributing Company Facilities, Everett, Washington, April.
- . 1996d. "Off-Site Contamination Source Assessment", Mobil Oil Corporation and American Distributing Bulk Plants, Everett, Washington. October.
- . 1996e. Review of LPH Pilot Test, Mobil Oil Corporation/American Distributing Company Bulk Plant Properties, Everett, Washington (letter). October 18.
- . 1996f. Weekly and Monthly Field Reports regarding the CSO line repair. April to December.
- . 1997. LPH Recovery Technical Memorandums. Mobil Oil Corporation/American Distributing Company Bulk Plant Properties, Everett, Washington. February to December.
- AMEC Earth & Environmental, Inc. (AMEC). 2007. "Forth Quarter 2006: Groundwater Sampling and Liquid-Phase Hydrocarbon Recovery Report" ExxonMobil/ADC Properties, 2717-2731 Federal Avenue, Everett, Washington. March 5.
- . 2006. "First Quarter 2007: Groundwater Sampling and Liquid-Phase Hydrocarbon Recovery Report" ExxonMobil/ADC Properties, 2717-2731 Federal Avenue, Everett, Washington. June 27.
- . 2007. Video Survey of Storm Drain System East End of Site, ExxonMobil/ADC Properties, 2717-2731 Federal Avenue, Everett, Washington (letter). March, 23.
- . 2008a. Off-Site Groundwater Monitoring Well Installation Report, 2717-2731 Federal Avenue, Everett, Washington. April 22.
- . 2008b. Tidal Study Report, Former Mobil Oil Terminal 46-108, 2717-2731 Federal Avenue, Everett, Washington (letter). June 12.
- City of Everett (Everett). 2002. Everett Shoreline Master Program, Section 1- Introduction. <http://www.everettwa.org/default.aspx?ID=869>.
- . 2006. Fish & Wildlife Habitat Conservation Areas Critical Areas Map 6. City of Everett Planning and Community Development.
- . 2009. Critical Areas Map 1. City of Everett Planning and Community Development.

- Dilgard and Riddle, 1973. "Shoreline Historical Survey Report", Shoreline Master Plan Committee for City of Everett. 1973.
- Exponent. 1998a. "Remedial Investigation and Focused Feasibility Study", Mobil and ADC/Miller Properties, Everett, Washington. July 23.
- . 1998b. "Interim Action Workplan and Engineering Design Report," Mobil and ADC/Miller Properties, Everett, Washington. July 23.
- . 2000. "Closure Report", Mobil and ADC/Miller Properties, Everett, Washington. February.
- Kleinfelder, Inc. 2001. "Annual Liquid Petroleum Hydrocarbon Recovery Report", Mobil and ADC/Miller Properties, Everett, Washington. February 15.
- . 2001. Liquid Petroleum Hydrocarbon Recovery Options, Mobil and ADC/Miller Properties, Agreed Order DE98TCP-N223 (letter). March 29.
- . 2001. Liquid Petroleum Hydrocarbon 2001 Monitoring and Recovery Schedule, Mobil and ADC/Miller Properties, Agreed Order DE98TCP-N223 (letter). March 30.
- . 2001. 2001 Groundwater Monitoring Schedule, Mobil and ADC/Miller Properties, Agreed Order DE98TCP-N223 (letter). March 30.
- Miller, J.F., Frederick, R.H., and Tracey, R.H. 1973. Precipitation Frequency Atlas of the United States, Volume IX—Washington: National Weather Service, Silver Spring, Maryland. Prepared for Soil Conservation Service, Engineering Division.
- National Wetland Inventory (NWI). 2009. Online Mapper. Retrieved May 1, 2009 from <http://www.fws.gov/wetlands/Data/mapper.html>.
- Peck, Norman D. of the Washington Department of Ecology. 1997. Re: Removal of Containment Boom at Dunlap Towing, Everett, WA (letter). January 22.
- Peck, Norman D. and Polayes, Joanne of the Washington Department of Ecology. 1997. Re: Mobil-American Distributing Site (letter). December 30
- Polayes, Joanne of the Washington Department of Ecology. 2000. Completion of Construction Portion of the Interim Action at the Mobil and ADC/Miller Properties (letter), Everett, Washington. March 23.
- Premier (Premier Environmental Services, LLC.). 2002. Annual Liquid Petroleum Hydrocarbon Recovery Report, ExxonMobil Corporation/American Distributing Company (ExxonMobil/ADC) Site, Everett, Washington, Agreed Order DE 98TCP-N223 (letter). March 1.
- PTI (PTI Environmental Services). 1997a. "LPH Recovery Technical Memorandum," Federal Avenue Site, Everett, Washington. February.

- PTI. 1997b. Proposal for Completion of the MTCA Process, Federal Avenue Site, Everett, Washington (letter). September 5.
- Rittenhouse-Zeman & Associates, Inc. (RZA). 1985. "Preliminary Soil and Ground Water Quality Study", Mobil Oil Corporation Bulk Plant, 2731 Federal Avenue, Everett, Washington, June.
- . 1989. "Remedial Action Update Report", Mobil Oil Corporation Bulk Plant, 2731 Federal Avenue, Everett, Washington, September 28.
- RZA AGRA Earth and Environmental, Inc. (RZA AGRA). 1992. "Quarterly Groundwater Sampling Report", Former Bulk Plant, Everett, Washington. March 22.
- . 1994. "Off-Site Subsurface Characterization and Recovery Trench Installation", Former Bulk Plant, Everett, Washington. April 18.
- URS Corporation. 2000a. Extended Phase I Environmental Site Assessment. Proposed California Street Overcrossing, Everett, Washington. February 9.
- URS Corporation. 2000b. Draft Report. Phase II Site Investigation Report, California Street Overcrossing, Everett, Washington. November 3.
- URS Corporation. 2001. Addendum 1. Geotechnical Investigation Report. California Street Overcrossing, Everett, Washington. April 13.
- Washington State Department of Ecology (Ecology). 2001. Model Toxics Control Act Cleanup Regulation, Chapter 173-340 WAC. Publication No. 94-06.
- Washington State Department of Ecology (Ecology). 2005. "Guidance on Remediation of petroleum-Contaminated Groundwater by Natural Attenuation", Publication No. 05-09-091 (Version 1.0), July.
- WRCC (Western Regional Climatic Center). 2009. Climatological Data Summaries: Everett Junior College, Washington. <http://www.wrcc.dri.edu/index.html>, accessed May 30, 2009.



## TABLES

**Table 1 Chronology of Historical On-Site Environmental Investigations and Remedial Actions**

<b>Date</b>	<b>Consultant</b>	<b>Location</b>	<b>Reference</b>	<b>Activities</b>	<b>Tasks Performed</b>	<b>Notes</b>
May-85	Rittenhouse-Zeman and Associates, Inc. (RZA)	ExxonMobil Parcel		Borings, monitoring well installation	2-inch diameter monitoring wells B-1 through B-5 (MW-1 through MW-5 in several reports) installed.	B-1, B-2, B-4, and B-5. Petroleum odor noticed in borings, evidence found of contamination below groundwater table.
Mar-88	RZA	ExxonMobil Parcel		Borings, monitoring well installation	2-inch diameter monitoring wells MW-6 through MW-18 installed.	Soil and groundwater samples collected. LPH (1.29 feet) measured in MW-14.
Apr-88	RZA	ExxonMobil Parcel		Recovery trench installation, SVE and groundwater treatment system test (oil-water separator and air stripper)	Installation of recovery trench near MW-14, soil vapor extraction system and groundwater treatment system to evaluate feasibility of extracting LPH	Decommissioned in 1998 during construction of low-permeability cap at the Property.
May-88	RZA	ExxonMobil Parcel		Infiltration gallery, pumping subsurface fluids	Infiltration gallery installed in the vicinity of MW-14. Subsurface fluids were pumped with a vacuum truck from the sumps.	The gallery was T-shaped and 45 ft long with two 55 gal drums installed at both ends as sumps. 1,400 gal of liquid removed, 50 gal was LPH. As a result, LPH thickness in MW-14 decreased to 0.40 ft by August 1988.
Mar-89	RZA	ExxonMobil Parcel		Automated groundwater extraction and treatment system	An automated groundwater extraction and treatment system was installed in the location of the infiltration gallery. The system included fluid extraction sump stationed in RW-1 (formerly MW-14), oil-water separator, air stripper, and reinfiltration gallery.	The groundwater extraction and treatment system was shut down in March 1990 due to flooding of the re-infiltration gallery, and has not been restarted.

**Table 1 Chronology of Historical On-Site Environmental Investigations and Remedial Actions**

<b>Date</b>	<b>Consultant</b>	<b>Location</b>	<b>Reference</b>	<b>Activities</b>	<b>Tasks Performed</b>	<b>Notes</b>
Jan-90	Environmental Science and Engineering, Inc. (ESE)	ADC Parcel		Borings	Hand auger AD-01 through AD-19	Soil samples collected.
Feb-90	ESE	ADC Parcel		Borings, monitoring well installation	HSA borings W-1 through W-7. 2-inch diameter monitoring wells W-1 through W-6 installed.	W-7 was backfilled.
Jun-90	ESE	ADC Parcel		Hand-auger borings	Hand-auger borings W-8 through W-17 hand	No soil data found for W-8 through W-17.
Oct-90	RZA	ExxonMobil Parcel		Shallow grid soil sampling, bio-feasibility study	Hand auger B-1 through B-25. Two soil sample studies for the purpose of conducting a slurry flask bio-feasibility study.	0-3 ft bgs. Rapid biodegradation of TPH-G fraction was observed. Biodegradation of TPH (undifferentiated) was not achieved.
Nov-90	Unknown	ExxonMobil Parcel		Monitoring wells decommissioning	B-3 (MW-3), B-4 (MW-4), and MW-7 destroyed	No documentation of well decommissioning.
Mar through June-91	RZA	Parcels surrounding ExxonMobil Parcel		Borings, monitoring well installation	2-inch diameter monitoring wells MW-19 through MW-24 and 4-inch diameter monitoring wells MW-27 through MW-30 installed. Soil boring B-21-91 advanced.	MW-25 and MW-26 were inaccessible or dry and later renamed as B-25 and B-26. No well decommissioning records were found.
Jun-91	RZA and ESE	The Property		Quarterly groundwater monitoring	Groundwater monitoring event. New 2-inch diameter monitoring wells MW-25 and MW-26 installed. Gauged wells: RW-1, B-1, B-2, B-5, MW-6, MW-8 through MW-13, MW-15 through MW-18, AD-19, W-1 through W-6, and W-8 through W-15.	B-1, MW-8, AD-19, W-1, W-6, W-9, W-11, W-12, W-13, and W-15 contained LPH and were not sampled. Results are presented in April 4, 1996, Groundwater Monitoring and Sampling Report by AGRA.

**Table 1 Chronology of Historical On-Site Environmental Investigations and Remedial Actions**

<b>Date</b>	<b>Consultant</b>	<b>Location</b>	<b>Reference</b>	<b>Activities</b>	<b>Tasks Performed</b>	<b>Notes</b>
Nov-91	RZA AGRA	ExxonMobil Parcel		Borings, recovery well	8-inch diameter recovery well RW-2 installed. Deep soil borings B-1A, B-8A, and B-15A advanced.	Soil borings advanced in vicinity of existing wells B-1, B-8, and B-15. No analytical data found for this event.
Dec-91	RZA AGRA Earth & Environmental, Inc. (RZA AGRA)	ExxonMobil Parcel		Quarterly groundwater monitoring, aquifer and tidal study	Quarterly groundwater monitoring. Gauged wells: RW-1, B-1, B-2, B-5, MW-6, MW-8 through MW-13, MW-15 through MW-30, and AD-19. 24-hour pumping from MW-10 at a rate of 1 to 2 gpm and measuring response in MW-18, RW-1, and RW-2 for 48 hours.	B-1, MW-8, MW-11, MW-26, MW-27, MW-29, and AD-19 contained LPH and were not sampled. Results are presented in April 4, 1996, Groundwater Monitoring and Sampling Report by AGRA. Hydraulic conductivity at the Site was estimated as 4 to 9.5 ft/day. Minimum tidal influence was observed.
1992	RZA AGRA			Discussions with Ecology	Ecology discussed enforcement with Mobil and RZA AGRA. Ecology decided to allow site to go independent.	
Dec-93	RZA AGRA	West of ExxonMobil Parcel		Off-Property borings, monitoring well installation, GPR survey	2-inch diameter monitoring wells MW-31 through MW-33 and MW-35 through MW-37 were installed; B-34 advanced and backfilled. GPR survey was conducted to assess whether underground product lines had been removed.	Survey did not identify any subsurface linear features.
Dec-93	RZA AGRA	ExxonMobil Parcel and off-site property to the west		Quarterly groundwater monitoring	Groundwater monitoring event. Gauged wells B-1, B-2, MW-6, MW-8 through MW-13, MW-15 through MW-18, MW-27 through MW-33, MW-35 through MW-37.	B-1, MW-27, and MW-29 contained LPH and were not sampled. Results are presented in April 4, 1996, Groundwater Monitoring and Sampling Report by AGRA.

**Table 1 Chronology of Historical On-Site Environmental Investigations and Remedial Actions**

<b>Date</b>	<b>Consultant</b>	<b>Location</b>	<b>Reference</b>	<b>Activities</b>	<b>Tasks Performed</b>	<b>Notes</b>
Dec-93	RZA AGRA	West of ExxonMobil Parcel		Test pits, recovery trench	Excavated five test pits TP-1 through TP-5. Recovery trench installation along the western border of ExxonMobil Parcel.	Monitoring well MW-21 was decommissioned during the recovery trench installation activities. However, a 2002 decommissioning record was found that stated that MW-21 was decommissioned in 2002.
1995				Agreed Order DE-95TC-N402		Required evaluation of LPH.
Jul-95	RZA AGRA	ADC Parcel		Quarterly groundwater monitoring	Groundwater monitoring event. Gauged wells: W-3, W-5, W-9, W-10, W-12 through W-15.	W-9, W-12, and W-13 contained LPH and were not sampled. Results are presented in April 4, 1996, Groundwater Monitoring and Sampling Report by AGRA.
Oct-95	U.S. Coast Guard Puget Sound Marine Safety Office & City of Everett	North of the Property		Investigation of petroleum product discharge into Everett Harbor	Camera surveys of the sewer lines	Outfall located approximately 175 yards northwest of the ADC parcel, section of Combined Sewer Outflow (CSO) line with LPH seepage.
Nov-95	RZA AGRA	Site		Groundwater monitoring	Groundwater monitoring event. Gauged wells: RW-1, B-1, B-2, MW-6, MW-8 through MW-13, MW-15 through MW-18, and MW-27 through MW-37.	B-1, MW-18, MW-29, and MW-30 contained LPH and were not sampled. Results are presented in April 4, 1996, Groundwater Monitoring and Sampling Report by AGRA.
Dec-95	RZA AGRA	Site		Groundwater monitoring	Groundwater monitoring event. Gauged wells: RW-2, B-2, MW-8, MW-9, MW-18, MW-15 through MW-18, MW-27, and MW-28.	RW-2, MW-9, MW-18, and MW-28 contained LPH and were not sampled. Results are presented in April 4, 1996, Groundwater Monitoring and Sampling Report by AGRA.

**Table 1 Chronology of Historical On-Site Environmental Investigations and Remedial Actions**

<b>Date</b>	<b>Consultant</b>	<b>Location</b>	<b>Reference</b>	<b>Activities</b>	<b>Tasks Performed</b>	<b>Notes</b>
Mar-96	AGRA	North of the Property		Borings	Direct-push soil borings GP-1 through GP-13. Borings associated with the CSO line repair.	The collected soil sample results indicated that soil surrounding the damaged portion of the CSO line were impacted with petroleum hydrocarbons. LPH accumulation was noticed in temporary screens installed in soil borings. No groundwater samples were collected from temporary screens.
Apr-96	City of Everett			Meeting	Meeting held to discuss options for repairing the section of CSO line.	Replacement of the settled portion of the line and slip lining of the remaining portion of the line was decided.
May-96	AGRA	ADC Parcel		Borings	Bobcat borings BB-1 through BB-14.	Soil samples collected.
Jun-96	AGRA	North of the Property		CSO line repairs	Excavation of settled portion of pipe replaced. Slip-lining of remaining CSO line. CSO line excavation dewatering.	1,450,800 gal of groundwater and 23,050 gal of LPH were removed during CSO line excavation and dewatering.
Jun-96	AGRA	ADC Parcel		Borings, monitoring wells, and test pits	4-inch diameter recovery well VRW-1 and 2-inch diameter monitoring well MW-38 installed. Seven test pits TP-1-96 through TP-7-96 excavated.	Wells were installed on the northeast corner of the property. Test pits were throughout the ADC Parcel.
Jun-96	AGRA	LPH Vacuum Recovery Pilot Test		LPH vacuum recovery pilot test	14-day test included SVE and groundwater/LPH pumping system.	125 gal of LPH and 28,228 gal of groundwater removed from VRW-1 during test.
Aug-96	AGRA	Site		Monitoring wells	Gauged wells at the property.	LPH found in B-1, VRW-1, MW-27, MW-29, MW-30, MW-38, W-1, W-9, W-15.

**Table 1 Chronology of Historical On-Site Environmental Investigations and Remedial Actions**

<b>Date</b>	<b>Consultant</b>	<b>Location</b>	<b>Reference</b>	<b>Activities</b>	<b>Tasks Performed</b>	<b>Notes</b>
Feb-97	PTI Environmental Services (PTI)	Site		LPH recovery technical memorandum	Technical memorandum to summarize environmental investigations, LPH recovery activities, and geology.	PTI concluded that long-term, passive (LPH only) recovery may be the most effective method of LPH recovery.
Nov-97 Jan-98	Pacific Environmental Group, Inc. (PEG)	Kimberly-Clark Property		Boring, monitoring well	Direct push borings Probe-1 through Probe-15. 2-inch diameter HSA monitoring wells KC-1 and KC-2 inside the KC warehouse.	Groundwater samples were collected from temporary screens installed in each boring. LPH not identified in soil borings or monitoring wells. TPH-D and TPH-O were detected above MTCA Method A cleanup levels in borings advanced in the vicinity of repaired CSO line. Samples not collected in vicinity of former ASTs.
1998				Agreed Order DE98TC-P-N223		Required remedial investigation/focused feasibility study.
Jul-98	Exponent	Site		Remedial Investigation and Focused Feasibility Study	Report	Exponent recommended the installation of LPH recovery trenches and capping the property.
Nov-98	Kleinfelder, Inc. (Kleinfelder)	ADC Parcel		Survey, geotechnical evaluation	Initial survey. Asbestos survey prior to demolition.	Demolition activities included four buildings on the ADC parcel. Demolition completed in January 1999.

**Table 1 Chronology of Historical On-Site Environmental Investigations and Remedial Actions**

<b>Date</b>	<b>Consultant</b>	<b>Location</b>	<b>Reference</b>	<b>Activities</b>	<b>Tasks Performed</b>	<b>Notes</b>
Dec-98	Kleinfelder	The Property		Interim remedial action	Removed TPH-impacted soil, graded the property, removed purge water.	162 tons of contaminated shallow soil and vegetation removed from within the ADC firewall area during demolition and transported to TPS Technologies facility for disposal. 3.5 tons of class 3 petroleum-contaminated soil taken to CRS Associated. Marine Services, Inc. removed 110 gal of purge water.
1999	Kleinfelder	The Property		Interim remedial action (continued)	Monitoring well abandonment. Interceptor trench construction along the western and northern property boundaries. Low-permeability cap construction over the property. Recovery wells LPH-1 through LPH-9 installed in interceptor trench. Storm collection system that connects to the City of Everett sewer system was installed.	Monitoring wells abandoned (MW-6, MW-8, MW-9, MW-12, MW-13, MW-15, MW-16, MW-17, MW-38, WP-1, B-1, B-2, W-4, W-8, W-11, W-12, W-14, AD-11, AD-12, AD-13, AD-15, AD-19, W-10, W-15, and MW-40). Completed site grading, installation of two layers of geotextile fabric, asphalt-treated base material, and paving fabric and asphalt cap.
Oct-99	Kleinfelder	The Property		Monitoring wells installation	Monitoring wells W-10R, W-15R, and MW-40R.	Wells installed to replace wells W-10, W-15, and MW-40.
Dec-99	Dames and Moore	To the south and southeast from the Property		Geotechnical drilling and piezometer installation	DM-6, DM-7, and DM-8 were sampled for environmental samples.	Work associated with California Street Overcrossing (CSTO) Project.



**Table 1 Chronology of Historical On-Site Environmental Investigations and Remedial Actions**

<b>Date</b>	<b>Consultant</b>	<b>Location</b>	<b>Reference</b>	<b>Activities</b>	<b>Tasks Performed</b>	<b>Notes</b>
Sep-00	URS Corporation (URS)	To the south, east, and southeast from the Property		Borings	Phase II investigation for the CSTO Project. Push-probe borings UG-1 through UG-12.	Groundwater samples collected from temporary screens installed in UG-2 and UG-8. Estimated 7,600 cubic yards of petroleum-contaminated soil present along the overcrossing alignment.
Jul-01	URS	Johnston Petroleum parcel		Borings	Phase II investigation for Johnson Petroleum parcel. Push-probe borings JP-1 through JP-7.	Soil samples collected. Groundwater samples collected from JP-1, JP-4, and JP-7. No significant contamination found.
Feb-02	Environmental Resolutions, Inc. (ERI)	Site and vicinity		Monitoring wells decommissioning, monitoring well re-installment	Abandonment of monitoring wells (MW-22, MW-23, MW-24, MW-35, and MW-37) and piezometer DM-6 due to proximity to the CSTO Project. Re-installed well W-2.	No soil samples taken during W-2 installation.
2002	Reid Middleton	CSTO		Memorandum to Ecology	Southeast corner of the asphalt cap over the ExxonMobil Parcel removed. Steel piles for concrete foundation were installed.	No information regarding contaminant soil excavation and removal was found.
2002-2007	Kleinfelder, ERI, AMEC Earth & Environmental, Inc. (AMEC)	Site		Groundwater monitoring	Monthly LPH gauging and quarterly groundwater monitoring.	LPH greater than 0.02 ft thick is bailed manually and oleophilic socks are replaced.
Jul-02	ERI	West of the ExxonMobil Parcel		Well decommissioning	Monitoring wells MW-20, MW-21, and one unidentified well were decommissioned.	The record contradicts the records that indicate that MW-21 was decommissioned during the December 1993 recovery trench installation.

**Table 1 Chronology of Historical On-Site Environmental Investigations and Remedial Actions**

<b>Date</b>	<b>Consultant</b>	<b>Location</b>	<b>Reference</b>	<b>Activities</b>	<b>Tasks Performed</b>	<b>Notes</b>
2007-present	AMEC	Site		Groundwater monitoring	AMEC request to change to semiannual groundwater monitoring.	Request was accepted by Ecology.
2008	AMEC	West of the property		Monitoring wells	Off-property monitoring wells MW-A1 and MW-2A installed on the west side of Federal Avenue.	Monitoring wells MW-A1 and MW-2A are incorporated into existing groundwater monitoring network.
Feb-08	AMEC	Site		Tidal study	Tidal response was measured in W-3, W-6, MW-11, MW-28, and MW-40R	Minimal response in each well, except MW-11.
Jun-08	AMEC	Site		Well Head elevations survey	True North Land Surveying of Seattle, Washington, surveyed recovery and monitoring wells located on-site	Recovery wells LPH-1 through LPH-9 and monitoring wells W-1, W-2, W-3, W-6, W-10R, MW-10, MW-11, W-15R, W-17, RW-2, MW-19, MW-27, MW-28, MW-29, MW-30, MW-40R, and MW-A1 and MW-A2.
Jun-08	Floyd   Snider	North-Northeast of the property		Excavation and disposal of PCS and dewatering the excavation	Soil associated with Puget Sound Outfall 5 (PSO 5) Overflow Structure project was excavated and disposed off. In addition, dewatering also occurred during excavation.	Soil was field-screen. Soil that exhibited obvious signs of contamination was disposed off as Class II soil without sampling. Soil that appeared to be "clean", was sampled and then disposed as Class II soil. Water from the excavation was sampled for the City sewer discharge requirements.
2009	AMEC	Site		Proposed 2009 Agreed Order		Data Gap Investigations, followed by Focused Feasibility Study, and CAP.

**Table 1          Chronology of Historical On-Site Environmental Investigations and Remedial Actions**

Abbreviations

ADC = American Distributing Company  
AST = Above Ground Storage Tank  
bgs = below ground surface  
CAP = Cleanup Action Plan  
CSO = Combined Sewer Outflow  
CSTO = California Street Overcrossing  
Ecology = Washington State Department of Ecology  
ft = feet  
gal = gallons  
gpm = gallons per minute  
GPR = Ground Penetrating Radar  
HSA = Hollow Stem Auger  
KC = Kimberly-Clark  
LPH = Liquid Petroleum Hydrocarbons  
MTCA = Model Toxics Control Act  
PCS = petroleum-contaminated soil  
SVE = Soil Vapor Extraction  
TPH = Total Petroleum Hydrocarbons  
TPH-D = Total Petroleum Hydrocarbons-Diesel Range Organics  
TPH-G = Total Petroleum Hydrocarbons-Gasoline Range Organics  
TPH-O = Total Petroleum Hydrocarbons-Residual Range Organics

**Table 2 Analytical Results for Total Petroleum Hydrocarbons in Soil**

Sample ID	Depth (feet)	Date Sampled	Oil and Grease (mg/kg)	TPH (mg/kg)	TPH-Diesel (mg/kg)	TPH-Oil (mg/kg)
<b>MTCA Method A Cleanup Level Unrestricted/Residential</b>			2,000	2,000	2,000	2,000
AD-1	0.5 to 1	1/15/1990	--	780	--	--
AD-1	3	1/15/1990	--	3,900	--	--
AD-1	3	1/15/1990	--	2,380 <sup>1</sup>	--	--
AD-2	0.5 to 1	1/15/1990	--	250	--	--
AD-2	2.5 to 3	1/15/1990	--	280	--	--
AD-3	0.5 to 1	1/15/1990	--	31	--	--
AD-3	1.5 to 2	1/15/1990	--	9	--	--
AD-4	0.5 to 1	1/15/1990	--	720	--	--
AD-5	0.5 to 1	1/15/1990	--	8,800	--	--
AD-5	1.5 to 2	1/15/1990	--	1,900	--	--
AD-5	2.5 to 3	1/15/1990	--	2,300	--	--
AD-5	2.5 to 3	1/15/1990	--	2,100 <sup>1</sup>	--	--
AD-6	0.5 to 1	1/15/1990	--	2,700	--	--
AD-7	0.5 to 1	1/15/1990	--	5,800	--	--
AD-8	0.5 to 1	1/15/1990	--	1,600	--	--
AD-8	2.5 to 3	1/15/1990	--	2,700	--	--
AD-8	2.5 to 3	1/15/1990	--	1,530 <sup>1</sup>	--	--
AD-8	4.5 to 5	1/15/1990	--	6,200	--	--
AD-8	4.5 to 5	1/15/1990	--	7,080 <sup>1</sup>	--	--
AD-9	0.5 to 1	1/15/1990	--	630	--	--
AD-9	1.5 to 2	1/15/1990	--	4,400	--	--
AD-10	0.5 to 1	1/15/1990	--	33,000	--	--
AD-11	0.5 to 1	1/15/1990	--	8,000	--	--
AD-11	1 to 1.5	1/15/1990	--	12,000	--	--
AD-12	0.5 to 1	1/15/1990	--	230	--	--
AD-12	2.5 to 3	1/15/1990	--	14,000	--	--
AD-12	2.5 to 3	1/15/1990	--	9900 <sup>1</sup>	--	--
AD-12	3 to 3.5	1/15/1990	--	16,000	--	--
AD-12	3 to 3.5	1/15/1990	--	12,800 <sup>1</sup>	--	--
AD-13	0.5 to 1	1/15/1990	--	4,400	--	--
AD-13	2 to 2.5	1/15/1990	--	27,000	--	--
AD-13	2 to 2.5	1/15/1990	--	24,900 <sup>1</sup>	--	--
AD-14	0.5 to 1	1/15/1990	--	13,000	--	--
AD-14	2 to 2.5	1/15/1990	--	17,000	--	--
AD-14	2 to 2.5	1/15/1990	--	9,500 <sup>1</sup>	--	--
AD-15	0.5 to 1	1/15/1990	--	61	--	--
AD-15	0.5 to 1	1/15/1990	--	7 <sup>1</sup>	--	--
AD-15	2.5 to 3	1/15/1990	--	2,400	--	--
AD-15	2.5 to 3	1/15/1990	--	3,340 <sup>1</sup>	--	--
AD-16	0.5 to 1	1/15/1990	--	2,200	--	--
AD-16	0.5 to 1	1/15/1990	--	1,370 <sup>1</sup>	--	--
AD-17	0.5 to 1	1/15/1990	--	8,500	--	--
AD-17	0.5 to 1	1/15/1990	--	8,100 <sup>1</sup>	--	--
AD-18	0.5 to 1	1/15/1990	--	24	--	--
AD-18	4 to 4.5	1/15/1990	--	520	--	--
AD-19	0.5 to 1	1/15/1990	--	23,000	--	--

**Table 2 Analytical Results for Total Petroleum Hydrocarbons in Soil**

Sample ID	Depth (feet)	Date Sampled	Oil and Grease (mg/kg)	TPH (mg/kg)	TPH-Diesel (mg/kg)	TPH-Oil (mg/kg)
<b>MTCA Method A Cleanup Level Unrestricted/Residential</b>			2,000	2,000	2,000	2,000
AD-19	1 to 1.5	1/15/1990	--	<b>100,000</b>	--	--
B-1_Soil Grab	0 to 1.5	10/9/1990	--	<b>2,117</b>	--	--
B-1_Soil Grab	1.5 to 2	10/9/1990	--	446	--	--
B-2_Soil Grab	0 to 1.5	10/9/1990	--	90.6	--	--
B-3_Soil Grab	0 to 1.5	10/9/1990	--	213	--	--
B-3_Soil Grab	1.5 to 3	10/9/1990	--	831	--	--
B-4_Soil Grab	0 to 1.5	10/9/1990	--	65.2	--	--
B-5_Soil Grab	0 to 1.5	10/9/1990	--	701	--	--
B-6_Soil Grab	0 to 1	10/9/1990	--	428	--	--
B-7_Soil Grab	0 to 1.5	10/9/1990	--	434	--	--
B-8_Soil Grab	0 to 1.5	10/9/1990	--	126	--	--
B-8_Soil Grab	1.5 to 3	10/9/1990	--	174	--	--
B-9_Soil Grab	0 to 1.5	10/9/1990	--	469	--	--
B-9_Soil Grab	1.5 to 3	10/9/1990	--	643	--	--
B-10_Soil Grab	0 to 1.5	10/9/1990	--	206	--	--
B-10_Soil Grab	1.5 to 2	10/9/1990	--	231	--	--
B-11_Soil Grab	0 to 1.5	10/9/1990	--	323	--	--
B-11_Soil Grab	1.5 to 3	10/9/1990	--	406	--	--
B-12_Soil Grab	0 to 1.5	10/9/1990	--	191	--	--
B-12_Soil Grab	1.5 to 3	10/9/1990	--	<b>11,775</b>	--	--
B-13_Soil Grab	0 to 1.5	10/9/1990	--	277	--	--
B-13_Soil Grab	1.5 to 3	10/9/1990	--	15.9	--	--
B-14_Soil Grab	0 to 1.5	10/9/1990	--	212	--	--
B-14_Soil Grab	1.5 to 3	10/9/1990	--	128	--	--
B-15_Soil Grab	0 to 1.5	10/9/1990	--	132	--	--
B-15_Soil Grab	1.5 to 3	10/9/1990	--	17	--	--
B-16_Soil Grab	0 to 1.5	10/9/1990	--	1,898	--	--
B-16_Soil Grab	1.5 to 2.5	10/9/1990	--	<b>9,718</b>	--	--
B-17_Soil Grab	0 to 1.5	10/9/1990	--	1,513	--	--
B-17_Soil Grab	1.5 to 3	10/9/1990	--	<b>2,139</b>	--	--
B-18_Soil Grab	0 to 1.5	10/9/1990	--	46	--	--
B-18_Soil Grab	1.5 to 3	10/9/1990	--	738	--	--
B-19_Soil Grab	0 to 1.5	10/9/1990	--	626	--	--
B-19_Soil Grab	1.5 to 3	10/9/1990	--	<b>10,577</b>	--	--
B-20_Soil Grab	0 to 1.5	10/9/1990	--	117	--	--
B-20_Soil Grab	1.5 to 3	10/9/1990	--	46.9	--	--
B-21_Soil Grab	0 to 1.5	10/9/1990	--	<b>2,116</b>	--	--
B-21_Soil Grab	1.5 to 3	10/9/1990	--	1,974	--	--
B-21-91	5	6/24/1991	--	<b>12,000</b>	--	--
B-21-91	5	6/24/1991	--	<b>4,700<sup>1</sup></b>	--	--
B-21-91	6	6/24/1991	--	27	--	--
B-21-91	6	6/24/1991	--	10 U	--	--
B-22_Soil Grab	0 to 1.5	10/9/1990	--	360	--	--
B-22_Soil Grab	1.5 to 3	10/9/1990	--	1,800	--	--
B-23_Soil Grab	0 to 1.5	10/9/1990	--	1,691	--	--
B-23_Soil Grab	1.5 to 3	10/9/1990	--	<b>6,421</b>	--	--
B-24_Soil Grab	0 to 1.5	10/9/1990	--	560	--	--

**Table 2 Analytical Results for Total Petroleum Hydrocarbons in Soil**

Sample ID	Depth (feet)	Date Sampled	Oil and Grease (mg/kg)	TPH (mg/kg)	TPH-Diesel (mg/kg)	TPH-Oil (mg/kg)
<b>MTCA Method A Cleanup Level Unrestricted/Residential</b>			2,000	2,000	2,000	2,000
B-25_Soil Grab	0 to 1.5	10/9/1990	--	76	--	--
B-25_Soil Grab	1.5 to 3	10/9/1990	--	29.8	--	--
B-34/S-2	4 to 5.5	12/6/1993	--	--	500	--
B-34/S-5	12.5 to 14	12/6/1993	--	--	<b>4,800</b>	--
CSO Log yard backfill		6/27/1996	--	--	<b>3,910</b>	586
CSO Log yard N-2		7/1/1996	--	--	58.9	221
CSO Log yard pipe		6/27/1996	--	--	45.2	25 U
CSO Log yard W-1		7/1/1996	--	--	27	67.3
DM-6		12/6/1999	--	--	44.3	25 U
DM-7		12/8/1999	--	--	482	225
DM-8		12/1/1999	--	--	44.4	102
GP-1	10	3/20/1996	--	--	276	--
GP-2	11.5	3/20/1996	--	--	322	--
GP-3	6	3/20/1996	--	--	1,370	--
GP-4	6	3/20/1996	--	--	297	--
GP-5	3	3/20/1996	--	--	30.4	--
GP-5	8.5	3/20/1996	--	--	703.2	--
GP-7	5.5	3/20/1996	--	--	<b>3,800</b>	<b>4,300</b>
GP-8	7	3/20/1996	--	--	77	160
GP-8	8	3/20/1996	--	--	6.55	--
GP-9	8	3/20/1996	--	--	<b>12,000</b>	<b>2,900</b>
GP-10	7 to 7	3/20/1996	--	--	383	--
GP-11	6.5	3/20/1996	--	--	92	60
GP-12	11	3/20/1996	--	--	382	--
GP-12	12.5	3/20/1996	--	--	414	--
GP-13	7	3/20/1996	--	--	2 U	--
GP-13	10	3/20/1996	--	--	15	41
JP-1	4 to 8	6/21/2001	--	--	73.8	100
JP-2	0 to 3	6/21/2001	--	--	134	341
JP-2	3 to 6	6/21/2001	--	--	379	942
JP-3	4 to 6	6/21/2001	--	--	10 U	25 U
JP-4	3 to 6	6/21/2001	--	--	180	58.2
JP-5	3 to 6	6/21/2001	--	--	210	375
JP-6	6 to 9	6/21/2001	--	--	26.6	69.3
JP-7	1 to 2	6/21/2001	--	--	264	923
MW-6	2.5	3/9/1988	180	80	--	--
MW-7	2.5	3/9/1988	605	605	--	--
MW-8	2.5	3/9/1988	1,680	1,580	--	--
MW-9	2.5	3/9/1988	<b>33,500</b>	<b>33,500</b>	--	--
MW-10	2.5	3/9/1988	1,380	1,260	--	--
MW-11	2.5	3/9/1988	<b>10,100</b>	<b>9,480</b>	--	--
MW-12	2.5	3/9/1988	5 U	5 U	--	--
MW-15	2.5	3/9/1988	<b>3,430</b>	<b>3,030</b>	--	--
MW-16	2.5	3/9/1988	5 U	5 U	--	--
MW-17	2.5	3/9/1988	174	124	--	--
MW-18	2.5	3/9/1988	777	777	--	--
MW-19	2 to 3.5	3/11/1991	--	53	--	--

**Table 2 Analytical Results for Total Petroleum Hydrocarbons in Soil**

Sample ID	Depth (feet)	Date Sampled	Oil and Grease (mg/kg)	TPH (mg/kg)	TPH-Diesel (mg/kg)	TPH-Oil (mg/kg)
<b>MTCA Method A Cleanup Level Unrestricted/Residential</b>			2,000	2,000	2,000	2,000
MW-19	2 to 3.5	3/11/1991	--	10 U <sup>1</sup>	--	--
MW-19	3.5 to 5	3/11/1991	--	14	--	--
MW-19	3.5 to 5	3/11/1991	--	10 U <sup>1</sup>	--	--
MW-20	2 to 3.5	3/11/1991	--	18	--	--
MW-20	2 to 3.5	3/11/1991	--	10 U <sup>1</sup>	--	--
MW-20	3.5 to 5	3/11/1991	--	20	--	--
MW-20	3.5 to 5	3/11/1991	--	10 U <sup>1</sup>	--	--
MW-21	1.5 to 3	3/11/1991	--	110	--	--
MW-21	1.5 to 3	3/11/1991	--	10 U <sup>1</sup>	--	--
MW-21	3.5 to 5	3/11/1991	--	12,000	--	--
MW-21	3.5 to 5	3/11/1991	--	4,700 <sup>1</sup>	--	--
MW-22	2.5 to 4	3/11/1991	--	41,000	--	--
MW-22	2.5 to 4	3/11/1991	--	7,300 <sup>1</sup>	--	--
MW-22	4 to 5.5	3/11/1991	--	24,000	--	--
MW-22	4 to 5.5	3/11/1991	--	430 <sup>1</sup>	--	--
MW-23	1 to 2.5	3/11/1991	--	300	--	--
MW-23	1 to 2.5	3/11/1991	--	10 U <sup>1</sup>	--	--
MW-24	2.5 to 4	3/11/1991	--	260	--	--
MW-24	2.5 to 4	3/11/1991	--	10 U <sup>1</sup>	--	--
MW-24	4 to 5.5	3/11/1991	--	1,300	--	--
MW-24	4 to 5.5	3/11/1991	--	10 U <sup>1</sup>	--	--
MW-27	2	6/24/1991	--	4,700	--	--
MW-27	2	6/24/1991	--	900	--	--
MW-27	3	6/24/1991	--	61	--	--
MW-27	3	6/24/1991	--	10 U <sup>1</sup>	--	--
MW-28	2	6/24/1991	--	93	--	--
MW-28	2	6/24/1991	--	10 U <sup>1</sup>	--	--
MW-28	3	6/24/1991	--	51	--	--
MW-28	3	6/24/1991	--	10 U <sup>1</sup>	--	--
MW-29	1	6/24/1991	--	590	--	--
MW-29	1	6/24/1991	--	220 <sup>1</sup>	--	--
MW-29	2	6/24/1991	--	730,000	--	--
MW-29	2	6/24/1991	--	160,000	--	--
MW-30	2	6/24/1991	--	4,900	--	--
MW-30	2	6/24/1991	--	820	--	--
MW-30	3	6/24/1991	--	7,700	--	--
MW-30	3	6/24/1991	--	3,000	--	--
MW-31	12.5 to 14	12/6/1993	--	--	49	--
MW-31	2.5 to 4	12/6/1993	--	--	13	--
MW-32	12.5 to 14	12/6/1993	--	--	17	--
MW-32	7.5 to 9	12/6/1993	--	--	10 U	--
MW-33	12.5 to 14	12/6/1993	--	--	11	--
MW-33	5 to 6.5	12/6/1993	--	--	1,100	--
MW-35	12.5 to 14	12/6/1993	--	--	16	--
MW-35	2.5 to 4	12/6/1993	--	--	10 U	--
MW-36	12.5 to 14	12/6/1993	--	--	22	--

**Table 2 Analytical Results for Total Petroleum Hydrocarbons in Soil**

Sample ID	Depth (feet)	Date Sampled	Oil and Grease (mg/kg)	TPH (mg/kg)	TPH-Diesel (mg/kg)	TPH-Oil (mg/kg)
<b>MTCA Method A Cleanup Level Unrestricted/Residential</b>			2,000	2,000	2,000	2,000
MW-36	2.5 to 4	12/6/1993	--	--	700	--
MW-37	2.5 to 4	12/6/1993	--	--	<b>3,500</b>	--
MW-37	12.5 to 14	12/6/1993	--	--	380	--
MW-A1	7.5 to 8	2/4/2008	--	--	74.1	79.5
MW-A1	8.5 to 9	2/4/2008	--	--	<b>5,160</b>	471 U
MW-A2	6 to 6.5	2/4/2008	--	--	33.3	290
MW-A2	7.5 to 8	2/4/2008	--	--	<b>2,370</b>	279
RW-1/MW-14	2.5	3/9/1988	1,730	1,730	--	--
TP-2	3.5	12/6/1993	--	--	10 U	--
TP-2	3.5	12/8/1993	--	--	--	--
TP-3	3.5	12/6/1993	--	--	16	--
TP-3	3.5	12/8/1993	--	--	--	--
TP-5	3.5	12/6/1993	--	--	10 U	--
TP-5	3.5	12/8/1993	--	--	--	--
UG-1	5 to 7	9/25/2000	--	--	<b>27,100</b>	<b>52,300</b>
UG-2	10 to 12	9/25/2000	--	--	364	353
UG-3	7.5 to 9.5	9/25/2000	--	--	190	79.5
UG-4	5 to 7	9/25/2000	--	--	10 U	25 U
UG-5	5 to 7	9/25/2000	--	--	10 U	25 U
UG-6	5 to 7	9/26/2000	--	--	10 U	25 U
UG-7	2.5 to 4.5	9/26/2000	--	--	402	1,860
UG-8	5 to 7	9/26/2000	--	--	<b>5,180</b>	730
UG-9	2.5 to 4.5	9/26/2000	--	--	<b>8,560</b>	327
UG-9	10 to 12	9/26/2000	--	--	<b>2,170</b>	320
UG-10	5 to 7	9/26/2000	--	--	10 U	25 U
UG-11	5 to 7	9/26/2000	--	--	153	176
UG-12	5 to 7	9/26/2000	--	--	10 U	25 U
W-1	3	2/23/1990	--	<b>13,000</b>	--	--
W-2	3	2/23/1990	--	<b>17,000</b>	--	--
W-3	3	2/23/1990	--	28	--	--
W-4	3	2/23/1990	--	<b>4,600</b>	--	--
W-5	3	2/23/1990	--	<b>2,300</b>	--	--
W-6	3	2/23/1990	--	1,200	--	--
W-7	3	2/23/1990	--	910	--	--

Notes:

1. Duplicate result analyzed using EPA Method 8015 Modified. The primary results were analyzed using EPA Method 418.1.

mg/kg = milligrams per kilogram

MTCA = Model Toxics Control Act

TPH = Total Petroleum Hydrocarbon

U = Analyte not detected above the reporting limit indicated

-- = Not analyzed

**Bold and cell in orange = Result greater than MTCA A CUL criteria**



**Table 3 Analytical Results for TPH as Gasoline, Benzene, Toluene, Ethylbenzene, Total Xylenes, and Lead in Soil**

Sample ID	Depth	Date Sampled	TPH-Gas mg/kg	Benzene mg/kg	Ethylbenzene mg/kg	Toluene mg/kg	Total Xylene mg/kg	Lead mg/kg
MTCNA Method A Industrial Cleanup Level								1,000
MTCNA Method A Cleanup Level, Unrestricted/Residential			100/30 <sup>1</sup>	0.03	6	7	9	250
AD-1	3	1/15/1990	--	0.4 U	0.8 U	8 U	2 U	22
AD-5	2.5 to 3	1/15/1990	--	0.4 U	0.8 U	8 U	2 U	76
AD-8	2.5 to 3	1/15/1990	--	0.4 U	0.8 U	8 U	2 U	10
AD-8	4.5 to 5	1/15/1990	--	0.4 U	0.8 U	8 U	2 U	2.8
AD-12	2.5 to 3	1/15/1990	--	0.4 U	1.5	8 U	2 U	--
AD-12	3 to 3.5	1/15/1990	--	0.4 U	2.5	8 U	2 U	44
AD-13	2 to 2.5	1/15/1990	--	0.4 U	10	8 U	2 U	180
AD-14	2 to 2.5	1/15/1990	--	5.1	15	8 U	2 U	58
AD-15	0.5 to 1	1/15/1990	--	0.4 U	0.8 U	8 U	2 U	97
AD-15	2.5 to 3	1/15/1990	--	0.4 U	0.25	8 U	0.61	14
AD-16	0.5 to 1	1/15/1990	--	0.4 U	0.8 U	8 U	2 U	7.9
AD-17	0.5 to 1	1/15/1990	--	0.4 U	0.8 U	8 U	2 U	69
B-21-91	5	6/24/1991	--	0.035	2	0.53	8.8	30
B-21-91	6	6/24/1991	--	0.05 U	0.05 U	0.05 U	0.05 U	3.7
B-34/S-2	4 to 5.5	12/6/1993	670	0.63	2.6	0.05 U	0.9	15 U
B-34/S-5	12.5 to 14	12/6/1993	2,600	6.6	14	0.05 U	3.8	860
DM-6		12/6/1999	10.5	--	--	--	--	--
DM-7		12/8/1999	20.1	--	--	--	--	--
DM-8		12/1/1999	5 U	--	--	--	--	--
GP-7	5.5	3/20/1996	150	0.05 U	0.05 U	0.05 U	0.1 U	--
GP-8	7	3/20/1996	3.9	0.05 U	0.05 U	0.05 U	0.1 U	--
GP-9	8	3/20/1996	880	0.05 U	0.05 U	0.18	0.6	--
GP-11	6.5	3/20/1996	160	0.05 U	0.05 U	0.05 U	0.1 U	--
GP-13	10	3/20/1996	1 U	0.05 U	0.05 U	0.05 U	0.1 U	--
JP-1	4 to 8	6/21/2001	5 U	0.05 U	0.05 U	0.05 U	0.1 U	--
JP-2	0 to 3	6/21/2001	5 U	0.05 U	0.05 U	0.05 U	0.1 U	--
JP-2	3 to 6	6/21/2001	5 U	0.05 U	0.05 U	0.05 U	0.1 U	--
JP-3	4 to 6	6/21/2001	5 U	0.05 U	0.05 U	0.05 U	0.1 U	--
JP-4	3 to 6	6/21/2001	6.04	0.05 U	0.05 U	0.05 U	0.1 U	--
JP-5	3 to 6	6/21/2001	5 U	0.05 U	0.05 U	0.05 U	0.1 U	--
JP-6	6 to 9	6/21/2001	5 U	0.05 U	0.05 U	0.05 U	0.1 U	--
JP-7	1 to 2	6/21/2001	26.5	0.05 U	0.05 U	0.05 U	0.1 U	--
MW-6	2.5	3/9/1988	--	0.015 U	1.001	0.01 U	2.95	--
MW-7	2.5	3/9/1988	--	0.015 U	0.087 U	0.01 U	0.064 U	--
MW-8	2.5	3/9/1988	--	0.015 U	0.01 U	0.01 U	0.015 U	--
MW-9	2.5	3/9/1988	--	0.015 U	0.432	0.01 U	1.207	--
MW-10	2.5	3/9/1988	--	0.015 U	0.122	0.02	1.399	--
MW-11	2.5	3/9/1988	--	0.362	1.994	1.31	10.39	--
MW-12	2.5	3/9/1988	--	0.015 U	0.01 U	0.01 U	0.015 U	--
MW-15	2.5	3/9/1988	--	0.158 U	0.781	0.66	11.018	--
MW-16	2.5	3/9/1988	--	0.015 U	0.01 U	0.01 U	0.015 U	--
MW-17	2.5	3/9/1988	--	0.015 U	0.01 U	0.01 U	0.015 U	--
MW-18	2.5	3/9/1988	--	0.048	2.685	0.028	10.215	--

**Table 3 Analytical Results for TPH as Gasoline, Benzene, Toluene, Ethylbenzene, Total Xylenes, and Lead in Soil**

Sample ID	Depth	Date Sampled	TPH-Gas mg/kg	Benzene mg/kg	Ethylbenzene mg/kg	Toluene mg/kg	Total Xylene mg/kg	Lead mg/kg
<b>MTCA Method A Industrial Cleanup Level</b>								1,000
<b>MTCA Method A Cleanup Level, Unrestricted/Residential</b>			100/30 <sup>1</sup>	0.03	6	7	9	250
MW-19	2 to 3.5	3/11/1991	--	0.05 U	0.1 U	0.1 U	0.1 U	--
MW-19	3.5 to 5	3/11/1991	--	0.05 U	0.1 U	0.1 U	0.1 U	--
MW-20	2 to 3.5	3/11/1991	--	0.05 U	0.1 U	0.1 U	0.1 U	--
MW-20	3.5 to 5	3/11/1991	--	0.05 U	0.1 U	0.1 U	0.1 U	--
MW-21	1.5 to 3	3/11/1991	--	0.05 U	0.1 U	0.1 U	0.1 U	--
MW-21	3.5 to 5	3/11/1991	--	0.05 U	0.1 U	0.1 U	0.1 U	--
MW-22	2.5 to 4	3/11/1991	--	0.05 U	0.1 U	0.1 U	0.1 U	--
MW-22	4 to 5.5	3/11/1991	--	0.05 U	0.1 U	0.1 U	0.1 U	--
MW-23	1 to 2.5	3/11/1991	--	0.05 U	0.1 U	0.1 U	0.1 U	--
MW-24	2.5 to 4	3/11/1991	--	0.05 U	0.1 U	0.1 U	0.1 U	--
MW-24	4 to 5.5	3/11/1991	--	0.05 U	0.1 U	0.1 U	0.1 U	--
MW-27	2 to 2	6/24/1991	--	0.05 U	0.57	0.05 U	0.64	310
MW-27	3 to 3	6/24/1991	--	0.05 U	0.05 U	0.05 U	0.05 U	10
MW-28	2 to 2	6/24/1991	--	0.05 U	0.05 U	0.05 U	0.05 U	15
MW-28	3 to 3	6/24/1991	--	0.05 U	0.66	0.05 U	1.9	11
MW-29	1 to 1	6/24/1991	--	0.05 U	0.84	0.55	3.5	29
MW-29	2 to 2	6/24/1991	--	0.18	2.9	5.3	7.9	89
MW-30	2 to 2	6/24/1991	--	0.05 U	0.74	0.77	2.6	37
MW-30	3 to 3	6/24/1991	--	0.5	0.24	0.13	1	570
MW-31	12.5 to 14	12/6/1993	31	0.05 U	0.05 U	0.05 U	0.1 U	15 U
MW-31	2.5 to 4	12/6/1993	1 U	0.05 U	0.05 U	0.05 U	0.1 U	44
MW-32	12.5 to 14	12/6/1993	1 U	0.05 U	0.05 U	0.05 U	0.1 U	200
MW-32	7.5 to 9	12/6/1993	1 U	0.05 U	0.05 U	0.05 U	0.1 U	15 U
MW-33	12.5 to 14	12/6/1993	1 U	0.05 U	0.05 U	0.05 U	0.1 U	15 U
MW-33	5 to 6.5	12/6/1993	49	0.05 U	0.05 U	0.05 U	0.1 U	54
MW-35	12.5 to 14	12/6/1993	1.3	0.05 U	0.05 U	0.05 U	0.1 U	15 U
MW-35	2.5 to 4	12/6/1993	1 U	0.05 U	0.05 U	0.05 U	0.1 U	15 U
MW-36	12.5 to 14	12/6/1993	1 U	0.05 U	0.05 U	0.05 U	0.1 U	15 U
MW-36	2.5 to 4	12/6/1993	30	0.05 U	0.05 U	0.05 U	0.1 U	26
MW-37	12.5 to 14	12/6/1993	170	0.18	0.19	0.05 U	0.26	15 U
MW-37	2.5 to 4	12/6/1993	180	0.77	1.4	0.05 U	2.3	55
MW-A1	7.5 to 8	2/4/2008	50 U	0.0322 U	0.0322 U	0.0376	0.0965 U	--
MW-A1	8.5 to 9	2/4/2008	168	0.0319 U	0.0319 U	0.0319 U	0.0956 U	--
MW-A2	6 to 6.5	2/4/2008	10.2 U	0.102 U	0.102 U	0.102 U	0.306 U	--
MW-A2	7.5 to 8	2/4/2008	203	0.0355	0.04	0.0313 U	0.6	--
RW-1/MW-14	2.5	3/9/1988	--	0.575	2.348	1.301	12.975	--
TP-2	3.5	12/6/1993	1 U	0.05 U	0.05 U	0.05 U	0.1 U	10 U
TP-3	3.5	12/6/1993	3.4	0.05 U	0.05 U	0.05 U	0.1 U	10 U
TP-5	3.5	12/6/1993	1 U	0.05 U	0.05 U	0.05 U	0.1 U	10 U
UG-1	5 to 7	9/25/2000	173	--	--	--	--	--
UG-2	10 to 12	9/25/2000	55.3	--	--	--	--	--
UG-3	7.5 to 9.5	9/25/2000	108	--	--	--	--	--
UG-4	5 to 7	9/25/2000	5 U	--	--	--	--	--

**Table 3 Analytical Results for TPH as Gasoline, Benzene, Toluene, Ethylbenzene, Total Xylenes, and Lead in Soil**

Sample ID	Depth	Date Sampled	TPH-Gas mg/kg	Benzene mg/kg	Ethylbenzene mg/kg	Toluene mg/kg	Total Xylene mg/kg	Lead mg/kg
MTCA Method A Industrial Cleanup Level								1,000
MTCA Method A Cleanup Level, Unrestricted/Residential			100/30 <sup>1</sup>	0.03	6	7	9	250
UG-5	5 to 7	9/25/2000	5 U	--	--	--	--	--
UG-6	5 to 7	9/26/2000	5 U	--	--	--	--	--
UG-7	2.5 to 4.5	9/26/2000	5 U	--	--	--	--	--
UG-8	5 to 7	9/26/2000	<b>3410</b>	--	--	--	--	--
UG-9	2.5 to 4.5	9/26/2000	<b>6050</b>	2.5 U	34 U	5.5 U	30.5 U	--
UG-9	10 to 12	9/26/2000	<b>630</b>	--	--	--	--	--
UG-10	5 to 7	9/26/2000	5 U	--	--	--	--	--
UG-11	5 to 7	9/26/2000	5 U	--	--	--	--	--
UG-12	5 to 7	9/26/2000	5 U	--	--	--	--	--

Notes:

1. Cleanup level for TPH-Gas is 100 mg/kg when benzene is absent, and 30 mg/kg in presence of benzene.

mg/kg = milligrams per kilogram

MTCA = Model Toxics Control Act

U = Analyte not detected above the reporting limit indicated

-- = Not analyzed

Bold TPH-Gas = Result greater than 30 mg/kg but presence of benzene is unknown due to high detection limit

**Bold and cell in orange** = Result greater than MTCA Method A Unrestricted Land Use

cell in yellow = analyte not detected, but detection limit is greater than MTCA Unrestricted Land Use

**Bold and cell in green** = Result greater than MTCA Unrestricted Land Use but less than MTCA Method A Industrial Cleanup Level

Table 4 Analytical Results for Polycyclic Aromatic Hydrocarbons in Soil

Sample ID	Depth	Date Sampled	Acenaphthene (mg/kg)	Acenaphthylene (mg/kg)	Anthracene (mg/kg)	Benzo(a) anthracene* (mg/kg)	Benzo(a) pyrene* (mg/kg)	Benzo(b) fluoranthene* (mg/kg)	Benzo(g,h,i) perylene (mg/kg)	Benzo(k) fluoranthene* (mg/kg)	Chrysene* (mg/kg)	Dibenz(a,h) anthracene* (mg/kg)	Indeno(1,2,3-cd) pyrene* (mg/kg)	Naphthalene (mg/kg)	Phenanthrene (mg/kg)	Pyrene (mg/kg)	Total cPAH <sup>1</sup> TEQ-Adjusted (mg/kg)	
MTCA A Industrial CUL							2										2	
MTCA A Unrestricted/Residential CUL							0.1										0.1	
MTCA B Carcinogen CUL							0.14											
MTCA B Non-Carcinogen CUL			4,800		24,000									1,600		2,400		
B-34/S-2	4 to 5.5	12/6/1993	0.1 U	0.1 U	0.1 U	0.1 U	0.1 U	0.1 U	0.1 U	0.1 U	0.1 U	0.1 U	0.1 U	1.1	0.24	0.1 U	0.0755 U	
B-34/S-5	12.5 to 14	12/6/1993	2 U	2 U	4.9	2 U	2 U	2 U	2 U	2 U	2 U	2 U	2 U	2 U	4.9	2 U	1.51 U	
GP-7	5.5	3/20/1996	0.15 U	0.993	0.261	4.25	0.024	0.468	0.744	0.132	3.43	0.01 U	1.43	0.15 U	0.844	1.3	0.6868	
GP-8	7	3/20/1996	0.32	0.168	0.147	0.717	0.166	0.141	0.0728	0.0435	25.2	0.01 U	0.0967	0.15 U	0.669	0.02 U	0.51832	
GP-9	8	3/20/1996	1.27	2.98	0.15 U	0.01 U	0.105	0.173	0.412	0.111	12.4	0.409	0.0858	0.15 U	1.3	1.35	0.30738	
GP-11	6.5	3/20/1996	0.15 U	0.15 U	0.15 U	0.0859	0.0106	0.053	0.165	0.01 U	0.192	0.0644	0.0483	0.15 U	0.276	0.202	0.03818	
GP-13	10	3/20/1996	0.15 U	0.15 U	0.15 U	0.0479	0.0361	0.0173	0.01 U	0.0365	0.0597	0.0312	0.0157	0.15 U	0.15 U	0.0482	0.051557	
MW-31	2.5 to 4	12/6/1993	0.1 U	0.1 U	0.1 U	0.1 U	0.1 U	0.1 U	0.1 U	0.1 U	0.1 U	0.1 U	0.1 U	0.1 U	0.12	0.14	0.0755 U	
MW-31	12.5 to 14	12/6/1993	0.1 U	0.1 U	0.1 U	0.1 U	0.1 U	0.1 U	0.1 U	0.1 U	0.1 U	0.1 U	0.1 U	0.1 U	0.1 U	0.1 U	0.0755 U	
MW-32	7.5 to 9	12/6/1993	0.1 U	0.1 U	0.1 U	0.1 U	0.1 U	0.1 U	0.1 U	0.1 U	0.1 U	0.1 U	0.1 U	0.1 U	0.1 U	0.1 U	0.0755 U	
MW-32	12.5 to 14	12/6/1993	0.1 U	0.1 U	0.1	0.34	0.26	0.33	0.18	0.16	0.16	0.1 U	0.17	0.1 U	0.68	0.98	0.3666	
MW-33	5 to 6.5	12/6/1993	0.1 U	0.1 U	0.1 U	0.1 U	0.1 U	0.1 U	0.1 U	0.1 U	0.1 U	0.1 U	0.1 U	0.1 U	0.1 U	0.1 U	0.0755 U	
MW-33	12.5 to 14	12/6/1993	0.1 U	0.1 U	0.1 U	0.1 U	0.1 U	0.1 U	0.1 U	0.1 U	0.1 U	0.1 U	0.1 U	0.1 U	0.1 U	0.1 U	0.0755 U	
MW-35	2.5 to 4	12/6/1993	0.1 U	0.1 U	0.1 U	0.1 U	0.1 U	0.1 U	0.1 U	0.1 U	0.1 U	0.1 U	0.1 U	0.1 U	0.1 U	0.1 U	0.0755 U	
MW-35	12.5 to 14	12/6/1993	0.1 U	0.1 U	0.1 U	0.1 U	0.1 U	0.1 U	0.1 U	0.1 U	0.1 U	0.1 U	0.1 U	0.1 U	0.1 U	0.1 U	0.0755 U	
MW-36	2.5 to 4	12/6/1993	2 U	2 U	2 U	2 U	2 U	2 U	2 U	2 U	2 U	2 U	2 U	2 U	2 U	0.31	0.31	1.51 U
MW-36	12.5 to 14	12/6/1993	0.1 U	0.1 U	0.1 U	0.1 U	0.1 U	0.1 U	0.1 U	0.1 U	0.1 U	0.1 U	0.1 U	0.1 U	0.1 U	0.1 U	0.1 U	0.0755 U
MW-37	2.5 to 4	12/6/1993	0.5 U	0.5 U	0.5 U	0.5 U	0.5 U	0.5 U	0.5 U	0.5 U	0.5 U	0.5 U	0.5 U	0.5 U	0.5 U	0.5 U	0.5 U	0.3775 U
MW-37	12.5 to 14	12/6/1993	0.1 U	0.1 U	0.1 U	0.1 U	0.1 U	0.1 U	0.1 U	0.1 U	0.1 U	0.1 U	0.1 U	0.1 U	0.1 U	0.1 U	0.1 U	0.0755 U
TP-2	3.5	12/8/1993	0.1 U	0.1 U	0.1 U	0.1 U	0.1 U	0.1 U	0.1 U	0.1 U	0.1 U	0.1 U	0.1 U	0.1 U	0.1 U	0.1 U	0.1 U	0.0755 U
TP-3	3.5	12/8/1993	0.1 U	0.1 U	0.1 U	0.1 U	0.1 U	0.1 U	0.1 U	0.1 U	0.1 U	0.1 U	0.1 U	0.1 U	0.1 U	0.1 U	0.1 U	0.0755 U
TP-5	3.5	12/8/1993	0.1 U	0.1 U	0.1 U	0.1 U	0.1 U	0.1 U	0.1 U	0.1 U	0.1 U	0.1 U	0.1 U	0.1 U	0.1 U	0.1 U	0.1 U	0.0755 U

Notes:

- \* = Compounds is a cPAH compound included in calculations of TEQ-adjusted total cPAH concentration. Values for individual cPAH constituents are actual analytical results.
- 1. Total cPAH concentration expressed as TEQ-adjusted total cPAH concentration adjusted using Toxicity Equivalency Factors for maximum required cPAHs (Table 708-2 under WAC 173-340-708).
- cPAH = Carcinogenic Polycyclic Aromatic Hydrocarbon
- CUL = cleanup level
- mg/kg = milligrams per kilogram
- MTCA = Model Toxics Control Act
- TEQ = toxicity-equivalent quotient
- U = Sample was analyzed but not detected above the reporting limit indicated
- = Not analyzed
- Bold and cell in blue** = Benzo(a)pyrene result greater than MTCA Method A CUL Residential and MTCA Method B CUL Carcinogen but less than MTCA Method A CUL Industrial
- Bold and cell in yellow** = Analyte not detected, but detection limit is greater than MTCA Method A CUL Unrestricted and/or Industrial land use
- Bold and cell in orange** = Result for TEQ-adjusted total cPAHs greater than MTCA Method A residential/unrestricted CUL.

**Table 5 Analytical Results for Total Petroleum Hydrocarbons in Groundwater**

Well ID	Date Sampled	Oil and Grease (µg/L)	TPH (undifferentiated) (µg/L)	TPH-Diesel (µg/L)	TPH-Oil (µg/L)
MTCA Method A		500	500	500	500
B-2_well	3/27/1991	--	<b>3,800</b>	--	--
	6/24/1991	--	500 U	--	--
	12/26/1991	--	--	500 U	--
	12/9/1993	--	--	<b>780</b>	--
	11/21/1995	--	--	<b>4,400</b>	<b>3,900</b>
B-5_well	3/27/1991	--	1,000 U	--	--
MW-10	3/17/1988	<b>86,200</b>	86.2	--	--
	3/27/1991	--	<b>27,000</b>	--	--
	6/24/1991	--	500 U	--	--
	9/26/1991	--	--	<b>2,600</b>	--
	12/26/1991	--	--	<b>9,000</b>	--
	12/9/1993	--	--	<b>10,000</b>	--
	11/22/1995	--	--	<b>4,200</b>	<b>6,800</b>
	12/8/2000	--	--	<b>19,000</b>	<b>18,000 J</b>
2/28/2002	--	--	<b>5,700</b>	<b>2,300 J</b>	
MW-11	3/17/1988	<b>48,400</b>	41.4	--	--
	3/27/1991	--	<b>15,000</b>	--	--
	6/24/1991	--	<b>7,200</b>	--	--
	9/26/1991	--	--	<b>3,900</b>	--
	12/9/1993	--	--	<b>10,000</b>	--
	11/22/1995	--	--	<b>2,400</b>	<b>1,200</b>
	12/8/2000	--	--	230 J	400 U
	3/19/2001	--	--	<b>540</b>	310 J
	5/16/2001	--	--	<b>760</b>	<b>590</b>
	8/21/2001	--	--	<b>670</b>	<b>820</b>
	2/28/2002	--	--	460	<b>520</b>
	8/27/2002	--	--	<b>3,700</b>	<b>1,300 J</b>
	11/26/2002	--	--	480	<b>520</b>
	2/6/2003	--	--	460	460 J
	5/15/2003	--	--	470	440 J
	8/20/2003	--	--	<b>610</b>	<b>610</b>
	11/14/2003	--	--	360	330 J
	2/26/2004	--	--	430	410 J
	5/27/2004	--	--	270 J	310 J
	11/18/2004	--	--	500 J	480 U
	2/24/2005	--	--	240	430 J
	5/23/2005	--	--	470	380 J
	8/30/2005	--	--	79 U	98 U
	11/29/2005	--	--	160 J	200 J
	2/23/2006	--	--	77 U	96 U
	8/24/2006	--	--	93.9 U	93.9 U
	11/27/2006	--	--	108	94.3 U
2/12/2007	--	--	93.9 U	141	
8/29/2007	--	--	94.3 U	109	
2/11/2008	--	--	<b>19,200</b>	<b>1,280</b>	
2/12/2009	--	--	94.3 U	94.3 U	

**Table 5 Analytical Results for Total Petroleum Hydrocarbons in Groundwater**

Well ID	Date Sampled	Oil and Grease (µg/L)	TPH (undifferentiated) (µg/L)	TPH-Diesel (µg/L)	TPH-Oil (µg/L)
MTCA Method A		500	500	500	500
MW-12	3/17/1988	10,500	4	--	--
	3/27/1991	--	5,200	--	--
	6/24/1991	--	500 U	--	--
	9/26/1991	--	--	4,100	--
	12/26/1991	--	--	500 U	--
	12/9/1993	--	--	550	--
	11/22/1995	--	--	2,100	3,600
MW-13	3/17/1988	25,000	16.9	--	--
	3/27/1991	--	8,200	--	--
	6/24/1991	--	4,300	--	--
	9/26/1991	--	--	400 U	--
	12/9/1993	--	--	2,600	--
	11/22/1995	--	--	6,700	3,100
MW-15	3/17/1988	9,500	9.5	--	--
	3/27/1991	--	4,000	--	--
	6/24/1991	--	4,000	--	--
	9/26/1991	--	--	860	--
	12/26/1991	--	--	790	--
	12/9/1993	--	--	600	--
	11/21/1995	--	--	1,700	1,700
MW-16	3/17/1988	2,700	2.7	--	--
	3/27/1991	--	1,000 U	--	--
	6/24/1991	--	500 U	--	--
	9/26/1991	--	--	400 U	--
	12/26/1991	--	--	910	--
	12/9/1993	--	--	610	--
	11/21/1995	--	--	770	1,200
MW-17	3/17/1988	3,800	3.8	--	--
	3/27/1991	--	1,000 U	--	--
	6/24/1991	--	500 U	--	--
	9/26/1991	--	--	460	--
	12/26/1991	--	--	1,000	--
	12/9/1993	--	--	320	--
	11/21/1995	--	--	490	970
MW-18	3/17/1988	31,000	18	--	--
	3/27/1991	--	43,000	--	--
	6/24/1991	--	15,000	--	--
	9/26/1991	--	--	5,300	--
	12/26/1991	--	--	11,000	--
	12/9/1993	--	--	46,000	--
	11/21/1995	--	--	16,000	4,400
	2/28/2002	--	--	2,500	950 U
MW-19	3/27/1991	--	1,000 U	--	--
	6/24/1991	--	500 U	--	--
	9/26/1991	--	--	400 U	--
	12/26/1991	--	--	1,800	--
	12/7/2000	--	--	830 J	1,000 U
	3/19/2001	--	--	1,600	800

**Table 5 Analytical Results for Total Petroleum Hydrocarbons in Groundwater**

Well ID	Date Sampled	Oil and Grease (µg/L)	TPH (undifferentiated) (µg/L)	TPH-Diesel (µg/L)	TPH-Oil (µg/L)
MTCA Method A		500	500	500	500
MW-19 (continued)	5/16/2001	--	--	760	590
	8/21/2001	--	--	1,100	1,200
	2/28/2002	--	--	1,200	580
	8/27/2002	--	--	680	410 J
	11/26/2002	--	--	860	570
	2/6/2003	--	--	1,900	1,100 J
	5/15/2003	--	--	3,300	2,000
	8/20/2003	--	--	1,400 J	1,400 J
	11/14/2003	--	--	1,400	750
	2/26/2004	--	--	1,800 J	4,700 J
	5/27/2004	--	--	680	460 J
	8/30/2004	--	--	850	460 J
	11/18/2004	--	--	640	190 U
	2/24/2005	--	--	860	500
	5/23/2005	--	--	1,000	550 J
	8/30/2005	--	--	1,200	470 J
	11/29/2005	--	--	200 J	180 J
	2/12/2006	--	--	1,570	705
	2/23/2006	--	--	200 J	100 U
	8/24/2006	--	--	1,740	825
11/27/2006	--	--	209	118	
8/29/2007	--	--	1,390	547	
2/11/2008	--	--	794	587	
8/28/2008	--	--	1,050	1,200	
2/12/2009	--	--	993	303	
MW-20	3/27/1991	--	1,000 U	--	--
	6/24/1991	--	500 U	--	--
	9/26/1991	--	--	400 U	--
	12/26/1991	--	--	520	--
	12/7/2000	--	--	410 J	400 U
	3/19/2001	--	--	610	480 J
	5/17/2001	--	--	540	390 J
	2/28/2002	--	--	540	410 J
MW-21	3/27/1991	--	1,058,000	--	--
	6/24/1991	--	63,000	--	--
	2/28/2002	--	--	9,800	5,800
MW-22	3/27/1991	--	800,000	--	--
	12/26/1991	--	--	26,000	--
MW-23	3/27/1991	--	25,000	--	--
	6/24/1991	--	500 U	--	--
MW-24	3/27/1991	--	6,000	--	--
MW-27	6/24/1991	--	16,000	--	--
	9/26/1991	--	--	9,400	--
	11/21/1995	--	--	4,700	4,400

**Table 5 Analytical Results for Total Petroleum Hydrocarbons in Groundwater**

Well ID	Date Sampled	Oil and Grease (µg/L)	TPH (undifferentiated) (µg/L)	TPH-Diesel (µg/L)	TPH-Oil (µg/L)
MTCA Method A		500	500	500	500
MW-28	6/24/1991	--	<b>600</b>	--	--
	9/26/1991	--	--	400 U	--
	12/26/1991	--	--	500 U	--
	12/9/1993	--	--	<b>2,600</b>	--
	11/21/1995	--	--	<b>3,400</b>	<b>3,700</b>
MW-30	6/24/1991	--	<b>7,200</b>	--	--
	9/26/1991	--	--	<b>1,300</b>	--
	12/26/1991	--	--	<b>3,500</b>	--
	12/9/1993	--	--	<b>2,200</b>	--
MW-31	12/9/1993	--	--	470	--
	11/21/1995	--	--	470	<b>750 U</b>
MW-32	12/9/1993	--	--	490	--
	11/21/1995	--	--	400	<b>750 U</b>
MW-33	12/9/1993	--	--	<b>5,500</b>	--
	11/21/1995	--	--	<b>790</b>	<b>750 U</b>
MW-35	12/9/1993	--	--	<b>900</b>	--
	11/22/1995	--	--	330	<b>1,100</b>
	12/8/2000	--	--	160 J	400 U
	3/19/2001	--	--	190 J	200
MW-36	12/9/1993	--	--	<b>790</b>	--
	11/21/1995	--	--	<b>710</b>	<b>750 U</b>
MW-37	12/9/1993	--	--	<b>13,000</b>	--
	11/21/1995	--	--	<b>1,600</b>	<b>2,400</b>
MW-40R	12/8/2000	--	--	<b>11,000</b>	<b>6,400 J</b>
	3/19/2001	--	--	<b>20,000</b>	<b>14,000</b>
	5/16/2001	--	--	<b>18,000</b>	<b>14,000</b>
	8/21/2001	--	--	<b>15,000</b>	<b>8,100</b>
	2/28/2002	--	--	<b>13,000</b>	<b>6,500</b>
	8/27/2002	--	--	<b>6,600</b>	<b>2,700</b>
	11/26/2002	--	--	<b>5,900</b>	<b>3,600 J</b>
	2/6/2003	--	--	<b>9,100</b>	<b>5,300</b>
	5/15/2003	--	--	<b>14,000</b>	<b>7,200</b>
	8/20/2003	--	--	<b>16,000</b>	<b>6,300 J</b>
	11/14/2003	--	--	<b>5,300</b>	<b>2,300 J</b>
	2/26/2004	--	--	<b>13,000</b>	<b>4,600 J</b>
	5/27/2004	--	--	<b>11,000</b>	<b>4,800 J</b>
	8/30/2004	--	--	<b>15,000</b>	<b>5,000</b>
	2/24/2005	--	--	<b>4,200</b>	<b>1,900</b>
	5/23/2005	--	--	<b>15,000</b>	<b>4,200 J</b>
	8/30/2005	--	--	<b>23,000</b>	<b>6,600</b>
	11/29/2005	--	--	<b>2,100</b>	<b>790 J</b>
	2/23/2006	--	--	<b>2,000</b>	<b>540 U</b>
	8/24/2006	--	--	<b>6,550</b>	<b>2,090</b>
11/27/2006	--	--	<b>3,750</b>	<b>968</b>	
2/12/2007	--	--	<b>3,970</b>	<b>1,060</b>	
8/29/2007	--	--	<b>5,150</b>	<b>520</b>	
2/11/2008	--	--	<b>2,840</b>	<b>1,080</b>	
8/28/2008	--	--	<b>10,600</b>	<b>8,990</b>	
2/12/2009	--	--	<b>3,110</b>	<b>959</b>	



**Table 5 Analytical Results for Total Petroleum Hydrocarbons in Groundwater**

Well ID	Date Sampled	Oil and Grease (µg/L)	TPH (undifferentiated) (µg/L)	TPH-Diesel (µg/L)	TPH-Oil (µg/L)
MTCA Method A		500	500	500	500
MW-6	3/17/1988	12,400	1.1	--	--
	3/27/1991	--	1,000 U	--	--
	6/24/1991	--	500 U	--	--
	9/26/1991	--	--	400 U	--
	12/26/1991	--	--	5,500	--
	12/9/1993	--	--	670	--
	11/21/1995	--	--	800	1,400
MW-7	3/17/1988	4,700	1.6	--	--
MW-8	3/17/1988	132,000	11.5	--	--
	6/24/1991	--	1,300	--	--
	12/9/1993	--	--	26,000	--
	11/21/1995	--	--	3,300	3,100
MW-9	3/17/1988	7,600	1.5	--	--
	3/27/1991	--	1,000 U	--	--
	6/24/1991	--	500 U	--	--
	9/26/1991	--	--	770	--
	12/26/1991	--	--	4,800	--
	12/9/1993	--	--	2,600	--
	11/21/1995	--	--	3,300	3,300
MW-A1	2/11/2008	--	--	2,060	488
	8/28/2008	--	--	2,850	2,600
	2/12/2009	--	--	2,080	414
MW-A2	2/11/2008	--	--	1,310	550
	8/28/2008	--	--	1,790	1100
	2/12/2009	--	--	1840	339
RW-1/MW-14	8/22/1989	--	19,000	--	--
	3/27/1991	--	1,000 U	--	--
	6/24/1991	--	530	--	--
	9/26/1991	--	--	5,100	--
	12/26/1991	--	--	500 U	--
RW-2	2/11/2002	--	--	2,500	950 U
UG-2	9/25/2000	--	--	95	49
UG-8	9/25/2000	--	--	66,500	7,360
VWPT-1	6/6/1995	--	--	2,600	1,300
W-15R	2/28/2002	--	--	300,000	20,000 U
W-17	12/7/2000	--	--	53,000	26,000
	3/19/2001	--	--	12,000	6,400
	5/16/2001	--	--	43,000	19,000 J
	8/21/2001	--	--	31,000	9,800
W-2	3/2/1990	--	7,400	--	--
W-3	3/2/1990	--	530 U	--	--
	12/7/2000	--	--	990	350 J
	3/19/2001	--	--	900	370 J
	5/17/2001	--	--	1,500	440 J
	8/21/2001	--	--	700	360 J
	3/1/2002	--	--	810	750
	8/27/2002	--	--	1,100	540 J
	11/26/2002	--	--	850	260 J

**Table 5 Analytical Results for Total Petroleum Hydrocarbons in Groundwater**

Well ID	Date Sampled	Oil and Grease (µg/L)	TPH (undifferentiated) (µg/L)	TPH-Diesel (µg/L)	TPH-Oil (µg/L)
MTCA Method A		500	500	500	500
W-3 (continued)	2/6/2003	--	--	2,600	1,200
	5/15/2003	--	--	1,000	350 J
	8/20/2003	--	--	1,000	290 J
	11/14/2003	--	--	820	260 J
	2/26/2004	--	--	880	260 J
	5/27/2004	--	--	1,600	380 J
	8/30/2004	--	--	950	230 J
	11/18/2004	--	--	1,800 J	960 U
	2/24/2005	--	--	1,400	250 J
	5/23/2005	--	--	2,000	480 J
	8/30/2005	--	--	470	98 U
	11/29/2005	--	--	850	390 J
	2/23/2006	--	--	480	110 U
	8/24/2006	--	--	683	481
	11/27/2006	--	--	1,310	153
	2/12/2007	--	--	863	169
	8/29/2007	--	--	1,360	95.2 U
2/11/2008	--	--	1,720	508	
8/28/2008	--	--	2,100	1,840	
2/12/2009	--	--	1,400	364	
W-4	3/2/1990	--	23,200	--	--
W-5	3/2/1990	--	3,800	--	--
W-6	12/7/2000	--	--	32,000	15,000 J
	3/19/2001	--	--	25,000	10,000
	5/16/2001	--	--	49,000	23,000 J
	8/21/2001	--	--	20	6,400 J
	2/28/2002	--	--	680	740
	8/27/2002	--	--	160,000	71,000
	11/26/2002	--	--	3,600	3,300 J
	2/6/2003	--	--	8,800	6,300
	5/15/2003	--	--	18,000	11,000
	8/20/2003	--	--	59,000	29,000
	11/14/2003	--	--	6,100	3,700 J
	2/26/2004	--	--	20,000	15,000
	5/27/2004	--	--	19,000	16,000
	8/30/2004	--	--	10,000	6,400
	11/18/2004	--	--	900 J	530 J
	2/24/2005	--	--	13,000	11,000
	5/23/2005	--	--	8,800	5,000 J
	8/30/2005	--	--	170,000	120,000
	11/29/2005	--	--	1,500	2,600
	2/23/2006	--	--	270	610
8/24/2006	--	--	3,300	1,580	
11/27/2006	--	--	1,030	429	
2/12/2007	--	--	1,660	532	
8/29/2007	--	--	2,080	756	
2/21/2008	--	--	1,590	890	

**Table 5 Analytical Results for Total Petroleum Hydrocarbons in Groundwater**

Well ID	Date Sampled	Oil and Grease (µg/L)	TPH (undifferentiated) (µg/L)	TPH-Diesel (µg/L)	TPH-Oil (µg/L)
MTCA Method A		500	500	500	500
W-6 (continued)	8/26/2008	--	--	<b>27,900</b>	<b>23,800</b>
	2/12/2009	--	--	444	323

Notes:

J = The result is an approximation

µg/L = microgram per liter

MTCA = Model Toxics Control Act

TPH = Total Petroleum Hydrocarbon

U = Analyte not detected above the reporting limit indicated

-- = Not analyzed

**Bold and cell in orange** = Result greater than MTCA Method A cleanup level

**cell in yellow** = analyte not detected, but reporting limit is greater than MTCA Method A cleanup level

**Table 6 Analytical Results for TPH as Gasoline, Benzene, Toluene, Ethylbenzene, Total Xylenes, and Lead in Groundwater**

Well ID	Date Sampled	TPH-Gas (µg/L)	Benzene (µg/L)	Ethylbenzene (µg/L)	Toluene (µg/L)	Total Xylene (µg/L)	Dissolved Lead (µg/L)	Total Lead (µg/L)
MTCA Method A Cleanup Level		1,000/800	5	700	1,000	1,000	15	15
B-2_well	3/27/1991	--	1 U	1 U	1 U	1 U	--	--
	6/24/1991	--	1 U	1 U	1 U	1 U	--	--
	12/26/1991	50 U	0.5 U	0.5 U	0.5 U	0.5 U	--	--
	12/9/1993	50 U	0.5 U	0.5 U	1.1	1 U	2.8	20
	11/21/1995	50 U	0.78	0.5 U	0.5 U	1 U	--	--
	3/27/1991	--	1 U	1 U	1 U	1 U	--	--
MW-10	3/17/1988	--	27	12.7	30	192	--	--
	3/27/1991	--	5	4	7	6	--	--
	6/24/1991	--	1	1 U	1 U	1 U	--	--
	9/26/1991	1,800	19	0.5 U	0.5 U	7.2	--	--
	12/26/1991	960	11	0.5 U	0.55	2.5	--	--
	12/9/1993	1,100	0.88	0.5 U	1.6	3.8	2.3	65
	11/22/1995	1,300	1.3	0.5 U	0.5 U	2	--	--
	12/8/2000	1,100	0.84 J	4	1.1	4.1	--	--
2/28/2002	1,100	0.86 J	1 U	0.73 J	5	--	--	
MW-11	3/17/1988	--	149	18.5	12	160	--	--
	3/27/1991	--	205	68	25	86	--	--
	6/24/1991	--	36	15	13	20	--	--
	9/26/1991	440	3.7	0.5 U	0.5 U	1.1	--	--
	12/9/1993	880	90	9.9	0.5 U	25	5.5	110
	11/22/1995	790	36	1.8	0.8	1.6	--	--
	12/8/2000	48 U	2.8	0.2 U	0.22 J	0.6 U	--	--
	3/19/2001	48 U	0.46 J	0.2 U	0.2 U	0.6 U	--	--
	5/16/2001	48 U	0.2 U	0.2 U	0.2 U	0.6 U	--	--
	8/21/2001	48 U	0.2 U	0.2 U	0.2 U	0.6 U	--	--
	2/28/2002	48 U	0.2 U	0.2 U	0.2 U	0.6 U	--	--
	8/27/2002	48 U	1.3	0.2 U	0.2 U	0.6 U	--	--
	11/26/2002	48 U	0.94 J	0.2 U	0.2 U	0.6 U	--	--
	2/6/2003	48 U	0.92 J	0.2 U	0.2 U	0.6 U	--	--
	5/15/2003	70 J	4.4	1.5	8.7	9.3	--	--
	8/20/2003	48 U	0.2 U	0.2 U	0.3 J	0.6 U	--	--
	11/14/2003	48 U	0.5 J	0.6 J	0.9 J	3.2	--	--
	2/26/2004	48 U	0.2 U	0.5 J	0.2 U	1.7 J	--	--
	5/27/2004	48 U	0.2 U	0.3 J	0.5 J	1.2 J	--	--
	11/18/2004	48 U	0.9 J	0.6 J	0.8 J	2.4 J	--	--
	2/24/2005	48 U	0.2 U	0.5 J	0.4 J	2.1 J	--	--
	5/23/2005	140 J	1	3.5	9.5	19	--	--
	8/30/2005	48 U	0.2 U	0.2 U	0.2 U	0.6 U	--	--
	11/29/2005	48 U	0.2 U	0.2 U	0.2 U	0.6 U	--	--
	2/23/2006	51 J	0.9 J	1.8	2.8	6.8	--	--
	8/24/2006	100 U	1 U	1 U	1 U	3 U	--	--
11/27/2006	100 U	1 U	1 U	1 U	3 U	--	--	
2/12/2007	100 U	1 U	1 U	1 U	3 U	--	--	
8/29/2007	1 U	1 U	1 U	1 U	3 U	--	--	
2/11/2008	2,300	21.1	4.44	2.65	13.5	--	--	
2/12/2009	100 U	1 U	1 U	1 U	3 U	--	--	

**Table 6 Analytical Results for TPH as Gasoline, Benzene, Toluene, Ethylbenzene, Total Xylenes, and Lead in Groundwater**

Well ID	Date Sampled	TPH-Gas (µg/L)	Benzene (µg/L)	Ethylbenzene (µg/L)	Toluene (µg/L)	Total Xylene (µg/L)	Dissolved Lead (µg/L)	Total Lead (µg/L)
MTCA Method A Cleanup Level		1,000/800	5	700	1,000	1,000	15	15
MW-12	3/17/1988	--	<b>218</b>	2 U	7.2	146.5	--	--
	3/27/1991	--	1 U	1 U	1 U	3	--	--
	6/24/1991	--	1 U	1 U	1 U	1 U	--	--
	9/26/1991	160	2.1	0.42	0.5 U	0.56	--	--
	12/26/1991	65	<b>20</b>	0.5 U	0.43	2.9	--	--
	12/9/1993	50 U	<b>21</b>	0.5 U	0.86	3.2	4.3	<b>23</b>
	11/22/1995	50 U	<b>9.2</b>	0.5 U	0.5 U	1	--	--
MW-13	3/17/1988	--	<b>163</b>	42	8.9	169.8	--	--
	3/27/1991	--	1 U	2	1	1	--	--
	6/24/1991	--	1 U	1 U	1 U	1 U	--	--
	9/26/1991	500 U	0.5 U	0.5 U	0.5 U	0.5 U	--	--
	12/9/1993	50 U	2.2	0.5 U	0.5 U	1 U	5.5	<b>30</b>
	11/22/1995	120	<b>5.2</b>	0.5 U	0.5 U	1 U	--	--
MW-15	3/17/1988	--	<b>850</b>	108	351	<b>1,453</b>	--	--
	3/27/1991	--	5	31	9	204	--	--
	6/24/1991	--	<b>7</b>	13	2	29	--	--
	9/26/1991	220	0.5 U	0.5 U	0.5 U	0.5 U	--	--
	12/26/1991	<b>890</b>	<b>15</b>	34	1.1	69	--	--
	12/9/1993	140	1.4	1.8	0.95	1.8	3.7	<b>19</b>
	11/21/1995	<b>4,800</b>	<b>540</b>	26	9.8	140	--	--
MW-16	3/17/1988	--	2.5 U	2 U	2 U	2 U	--	--
	3/27/1991	--	1 U	1 U	1 U	1 U	--	--
	6/24/1991	--	1 U	1 U	1 U	1 U	--	--
	9/26/1991	500 U	0.5 U	0.5 U	0.5 U	0.5 U	--	--
	12/26/1991	50 U	0.5 U	0.5 U	0.5 U	0.5 U	--	--
	12/9/1993	50 U	0.5 U	0.5 U	0.7	1 U	2.8	<b>21</b>
	11/21/1995	50 U	0.5 U	0.5 U	0.5 U	1 U	--	--
MW-17	3/17/1988	--	2.5 U	2 U	2 U	2 U	--	--
	3/27/1991	--	<b>44</b>	1 U	1 U	1 U	--	--
	6/24/1991	--	<b>280</b>	1	4	2	--	--
	9/26/1991	<b>2,600</b>	<b>1,100</b>	0.5 U	0.5 U	0.5 U	--	--
	12/26/1991	<b>1,100</b>	<b>480</b>	1.3	2.2	4	--	--
	12/9/1993	50 U	<b>20</b>	0.5 U	0.88	1.4	6.5	10
	11/21/1995	50 U	<b>66</b>	0.5 U	0.53	1 U	--	--
MW-18	3/17/1988	--	<b>800</b>	115	194	<b>1,941</b>	--	--
	3/27/1991	--	<b>141</b>	24	22	158	--	--
	6/24/1991	--	1 U	1 U	1 U	1 U	--	--
	9/26/1991	750	0.69	0.5 U	0.5 U	2.4	--	--
	12/26/1991	<b>4,400</b>	<b>223</b>	24	0.5 U	0.5 U	--	--
	12/9/1993	<b>1,700</b>	<b>140</b>	8.3	0.5 U	58	6.1	<b>230</b>
	11/21/1995	<b>4,000</b>	<b>170</b>	5.9	2 U	3.7	--	--
	2/28/2002	<b>1,300</b>	<b>110</b>	0.98 J	1.6	7.8	--	--

**Table 6 Analytical Results for TPH as Gasoline, Benzene, Toluene, Ethylbenzene, Total Xylenes, and Lead in Groundwater**

Well ID	Date Sampled	TPH-Gas (µg/L)	Benzene (µg/L)	Ethylbenzene (µg/L)	Toluene (µg/L)	Total Xylene (µg/L)	Dissolved Lead (µg/L)	Total Lead (µg/L)
MTCA Method A Cleanup Level		1,000/800	5	700	1,000	1,000	15	15
MW-19	3/27/1991	--	1 U	1 U	1 U	1 U	--	--
	6/24/1991	--	1 U	1 U	1 U	1 U	--	--
	9/26/1991	150	0.5 U	0.5 U	0.5 U	0.5 U	--	--
	12/26/1991	130	0.5 U	0.5 U	0.5 U	0.5 U	--	--
	12/7/2000	700	0.2 U	2.2	0.2 U	3	--	--
	3/19/2001	580	0.2 U	5 U	1 U	6.7	--	--
	5/16/2001	48 U	0.2 U	0.2 U	0.2 U	0.6 U	--	--
	8/21/2001	400	0.2 U	0.2 U	1.1	1.3 J	--	--
	2/28/2002	220 J	0.2 U	0.2 U	0.2 U	2 J	--	--
	8/27/2002	160 J	0.2 U	0.2 U	0.2 U	0.81 J	--	--
	11/26/2002	210 J	0.21 J	0.2 U	0.2 U	0.92 J	--	--
	2/6/2003	260	0.34 J	0.2 U	0.2 U	0.66 J	--	--
	5/15/2003	300	1.8	0.9 J	5 U	6.6	--	--
	8/20/2003	240 J	<b>15</b>	0.7 J	1.2	2.7 J	--	--
	11/14/2003	220 J	0.3 J	0.3 J	0.3 J	1.4 J	--	--
	2/26/2004	93 J	0.2 U	0.2 U	0.2 U	0.6 U	--	--
	5/27/2004	210 J	0.2 U	0.2 U	0.2 U	0.6 U	--	--
	8/30/2004	230 J	0.2 U	0.2 U	1 U	1.1 J	--	--
	11/18/2004	130 J	0.2 U	0.2 U	0.2 U	0.6 U	--	--
	2/24/2005	180 J	0.2 U	0.2 U	0.2 U	1.2 J	--	--
	5/23/2005	<b>4,600</b>	<b>63</b>	92	340	530	--	--
	8/30/2005	160 J	0.2 U	0.2 U	0.2 U	0.6 U	--	--
	11/29/2005	48 U	0.2 U	0.2 U	0.2 U	0.6 U	--	--
2/12/2006	336	1 U	1 U	1 U	3 U	--	--	
2/23/2006	350	0.3 J	0.2 U	0.2 U	0.6 U	--	--	
8/24/2006	100 U	1 U	1 U	1 U	3 U	--	--	
11/27/2006	100 U	1 U	1 U	1 U	3 U	--	--	
8/29/2007	208	1 U	1 U	1 U	3 U	--	--	
2/11/2008	250 U	1 U	1 U	1 U	3 U	--	--	
8/28/2008	135	1 U	1 U	1 U	3 U	--	--	
2/12/2009	187	1 U	1 U	1 U	3 U	--	--	
MW-20	3/27/1991	--	1 U	1 U	1 U	1 U	--	--
	6/24/1991	--	1 U	1 U	1 U	1 U	--	--
	9/26/1991	110	0.5 U	0.5 U	0.5 U	0.5 U	--	--
	12/26/1991	50 U	0.5 U	0.5 U	0.5 U	0.5 U	--	--
	12/7/2000	84 J	0.21 J	0.2 U	0.2 U	0.99 J	--	--
	3/19/2001	69 J	0.2 U	0.2 U	0.2 U	0.6 U	--	--
	5/17/2001	68 J	0.2 U	0.2 U	0.2 U	0.61 J	--	--
	2/28/2002	56 J	0.2 U	0.2 U	0.2 U	0.6 U	--	--
MW-21	3/27/1991	--	3	2	2	25	--	--
	6/24/1991	--	<b>9</b>	110	220	560	--	--
	2/28/2002	310	0.62 J	1.5	1	2.8 J	--	--
MW-22	3/27/1991	--	1 U	1 U	2	7	--	--
	12/26/1991	<b>4,500</b>	0.5 U	0.5 U	0.5 U	0.5 U	--	--
MW-23	3/27/1991	--	1 U	1 U	2	8	--	--
	6/24/1991	--	1 U	1 U	1 U	2	--	--

**Table 6 Analytical Results for TPH as Gasoline, Benzene, Toluene, Ethylbenzene, Total Xylenes, and Lead in Groundwater**

Well ID	Date Sampled	TPH-Gas (µg/L)	Benzene (µg/L)	Ethylbenzene (µg/L)	Toluene (µg/L)	Total Xylene (µg/L)	Dissolved Lead (µg/L)	Total Lead (µg/L)
MTCA Method A Cleanup Level		1,000/800	5	700	1,000	1,000	15	15
MW-24	3/27/1991	--	1 U	1 U	2	1	--	--
MW-27	6/24/1991	--	1 U	3	7	9	--	--
	9/26/1991	500 U	0.5 U	0.5 U	0.5 U	0.5 U	--	--
	11/21/1995	160	0.5 U	0.5 U	0.5 U	1 U	--	--
MW-28	6/24/1991	--	1 U	1	1	3	--	--
	9/26/1991	500 U	0.5 U	0.5 U	0.5 U	0.5 U	--	--
	12/26/1991	59	0.5 U	0.5 U	0.5 U	0.5 U	--	--
	12/9/1993	94	0.5 U	0.5 U	0.5 U	1 U	2 U	120
	11/21/1995	50 U	0.5 U	0.5 U	0.5 U	1 U	--	--
MW-30	6/24/1991	--	40	0.5 U	150	70	--	--
	9/26/1991	280	1.6	0.5 U	0.5 U	0.68	--	--
	12/26/1991	680	1.8	0.5 U	0.5 U	0.5 U	--	--
	12/9/1993	320	1.6	0.5 U	0.5	1.3	2 U	11
MW-31	12/9/1993	50 U	0.5 U	0.5 U	0.5 U	1 U	2 U	24
	11/21/1995	50 U	0.5 U	0.5 U	0.5 U	1 U	--	--
MW-32	12/9/1993	50 U	0.5 U	0.5 U	0.5 U	1 U	2.2	92
	11/21/1995	50 U	0.5 U	0.5 U	0.5 U	1 U	--	--
MW-33	12/9/1993	50 U	0.5 U	0.5 U	1.7	1 U	4.7	99
	11/21/1995	50 U	0.5 U	0.5 U	0.5 U	1 U	--	--
MW-35	12/9/1993	50 U	2.9	0.5 U	0.5 U	1.6	2.8	77
	11/22/1995	50 U	2.7	0.5 U	0.5 U	1.7	--	--
	12/8/2000	48 U	0.62 J	0.2 U	0.32 J	3 U	--	--
	3/19/2001	48	0.2 U	0.2 U	0.2 U	0.6 U	--	--
MW-36	12/9/1993	50 U	0.5 U	0.5 U	0.75	1 U	2 U	45
	11/21/1995	50 U	0.5 U	0.5 U	0.5 U	1 U	--	--
MW-37	12/9/1993	3,900	630	26	0.5 U	12	2 U	140
	11/21/1995	50 U	0.5	0.5 U	0.5 U	1 U	--	--
MW-40R	12/8/2000	950	19	2.9	3.5	4.2	--	--
	3/19/2001	1,400	28	1.4	3.6	8.4	--	--
	5/16/2001	1,300	25	2.1	5.6	9	--	--
	8/21/2001	1,600	30	3.1	2.3	5.8	--	--
	2/28/2002	1,300	21	1.2	2.4	5.8	--	--
	8/27/2002	1,200	23	1.6	4.4	7.1	--	--
	11/26/2002	1,800	14	0.8 J	1.6	4.9	--	--
	2/6/2003	1,900	21	1.1	2.3	5.1	--	--
	5/15/2003	1,700	21	1.5	5.4	7.9	--	--
	8/20/2003	1,200	17	1.6	4.3	7	--	--
	11/14/2003	1,600	12	1.7	3	9	--	--
	2/26/2004	1,400	13	1.1	2.8	6.6	--	--
	5/27/2004	980	10	0.9 J	2.4	4.5	--	--
	8/30/2004	1,100	11	1.4	4.2	7.6	--	--
	2/24/2005	1,200	9.1	1.3	2.4	6.7	--	--
	5/23/2005	1,700	17	12	42	69	--	--
	8/30/2005	910	13	2.6	6.4	8.8	--	--
	11/29/2005	1,100	10 U	1.4	2.6	5.6	--	--
2/23/2006	1,200	10 U	1.4	3.1	5.6	--	--	

**Table 6 Analytical Results for TPH as Gasoline, Benzene, Toluene, Ethylbenzene, Total Xylenes, and Lead in Groundwater**

Well ID	Date Sampled	TPH-Gas (µg/L)	Benzene (µg/L)	Ethylbenzene (µg/L)	Toluene (µg/L)	Total Xylene (µg/L)	Dissolved Lead (µg/L)	Total Lead (µg/L)
MTCA Method A Cleanup Level		1,000/800	5	700	1,000	1,000	15	15
MW-40R (continued)	8/24/2006	410	<b>6.38</b>	1 U	1.88	7.55	--	--
	11/27/2006	<b>1,390</b>	<b>6.42</b>	2.68	1.32	5.05	--	--
	2/12/2007	<b>1,560</b>	<b>6.38</b>	3.14	1 U	3 U	--	--
	8/29/2007	<b>1,000</b>	<b>6.6</b>	1 U	1.5	3.48	--	--
	2/11/2008	<b>1,100</b>	3.18	1.09	1.24	7.12	--	--
	8/28/2008	<b>1,070</b>	4.91	1.2	2.29	5.97	--	--
	2/12/2009	<b>855</b>	3.65	1.25	3.39	6.4	--	--
MW-6	3/17/1988	--	2.5 U	2 U	2 U	2 U	--	--
	3/27/1991	--	1 U	1 U	1 U	1 U	--	--
	6/24/1991	--	1	1 U	1 U	1 U	--	--
	9/26/1991	500 U	0.5 U	0.5 U	0.5 U	0.5 U	--	--
	12/26/1991	760	<b>47</b>	45	8.3	19	--	--
	12/9/1993	50 U	0.5 U	0.5 U	0.83	1 U	12	14
	11/21/1995	50 U	0.5 U	0.5 U	0.5 U	1 U	--	--
MW-7	3/17/1988	--	2.5 U	2 U	2 U	2 U	--	--
MW-8	3/17/1988	--	<b>1,050</b>	359	37	237	--	--
	6/24/1991	--	<b>47</b>	5	72	17	--	--
	12/9/1993	130	0.71	0.5 U	0.5	1 U	3.2	<b>79</b>
	11/21/1995	110	<b>7.7</b>	0.5 U	0.5 U	1 U	--	--
MW-9	3/17/1988	--	2.5 U	2 U	2 U	2 U	--	--
	3/27/1991	--	<b>140</b>	8	3	20	--	--
	6/24/1991	--	<b>280</b>	1	4	2	--	--
	9/26/1991	220	1.1	0.5 U	0.5 U	0.54	--	--
	12/26/1991	50 U	<b>9.3</b>	0.5 U	0.5 U	0.5 U	--	--
	12/9/1993	50 U	<b>6.7</b>	0.5 U	0.5 U	1 U	4.2	<b>70</b>
	11/21/1995	50 U	1.3	0.5 U	0.5 U	1 U	--	--
MW-A1	2/11/2008	250 U	1 U	1 U	1 U	3 U	--	--
	8/28/2008	134	1 U	1 U	1 U	3 U	--	--
	2/12/2009	145	1 U	1 U	1 U	3 U	--	--
MW-A2	2/11/2008	250 U	1 U	1 U	1 U	3 U	--	--
	8/28/2008	159	1 U	1 U	1 U	3 U	--	--
	2/12/2009	188	1 U	1 U	1 U	3 U	--	--
RW-1/ MW-14	8/22/1989	--	1 U	1 U	1 U	1 U	--	--
	3/27/1991	--	5	1 U	1 U	8	--	--
	6/24/1991	--	1 U	1 U	1 U	1	--	--
	9/26/1991	<b>2,200</b>	<b>410</b>	19	6.4	10	--	--
	12/26/1991	<b>3,200</b>	<b>590</b>	170	11	56	--	--
RW-2	2/11/2002	<b>1,300 J</b>	<b>110</b>	0.98 J	1.6	7.8	--	--
UG-2	9/25/2000	5.98	<b>61</b>	2.5 U	7.45 U	31 U	--	--
UG-8	9/25/2000	5.31	--	--	--	--	--	--
W-15R	2/28/2002	<b>5,000</b>	<b>520</b>	8.1	7.8	11	--	--
W-17	12/7/2000	<b>2,600</b>	0.67 J	0.2 U	6.6	3.2	--	--
	3/19/2001	<b>2,000</b>	0.2 U	10 U	1.1	11	--	--
	5/16/2001	500	0.2 U	0.2 U	0.51 J	2.8 J	--	--
	8/21/2001	<b>1,900</b>	1 U	0.54 J	0.2 U	0.6 U	--	--
W-2	3/2/1990	--	0.3 U	0.3 U	0.5	1	--	--



**Table 6 Analytical Results for TPH as Gasoline, Benzene, Toluene, Ethylbenzene, Total Xylenes, and Lead in Groundwater**

Well ID	Date Sampled	TPH-Gas (µg/L)	Benzene (µg/L)	Ethylbenzene (µg/L)	Toluene (µg/L)	Total Xylene (µg/L)	Dissolved Lead (µg/L)	Total Lead (µg/L)
MTCA Method A Cleanup Level		1,000/800	5	700	1,000	1,000	15	15
W-3	3/2/1990	--	0.3 U	0.3 U	0.3 U	0.3 U	--	--
	12/7/2000	410	0.2 U	0.72 UJ	1 U	1.2 J	--	--
	3/19/2001	280	0.2 U	0.2 U	0.2 U	0.8 J	--	--
	5/17/2001	290	0.2 U	0.2 U	0.2 U	0.61 J	--	--
	8/21/2001	230 J	0.2 U	0.2 U	0.47 J	0.6 U	--	--
	3/1/2002	84 J	0.2 U	0.2 U	0.2 U	0.6 U	--	--
	8/27/2002	460	0.2 U	0.2 U	0.2 J	0.6 U	--	--
	11/26/2002	460	1 U	0.2 U	0.2 U	0.6 J	--	--
	2/6/2003	390	1 U	0.2 U	0.26 J	0.94 J	--	--
	5/15/2003	400	1.6	1 J	4.4	6.5	--	--
	8/20/2003	290	0.2 U	0.2 U	0.2 U	0.6 U	--	--
	11/14/2003	370	3.8	1.5	3	7.3	--	--
	2/26/2004	200 J	0.2 J	0.2 U	0.2 U	0.9 J	--	--
	5/27/2004	200 J	0.2 J	0.3 J	0.5 J	1.2 J	--	--
	8/30/2004	220 J	0.4 J	0.8 J	5 U	5 U	--	--
	11/18/2004	390	1.3	0.9 J	1.3	3.7	--	--
	2/24/2005	230 J	0.2 U	0.2 U	0.2 U	0.6 U	--	--
	5/23/2005	550	2.3	5.3	17	30	--	--
	8/30/2005	170 J	0.2 U	0.2 U	0.2 U	0.6 U	--	--
	11/29/2005	450	0.2 U	0.2 U	0.2 U	0.6 U	--	--
2/23/2006	270	2 U	1.2	2.2	4.8	--	--	
8/24/2006	100 U	1 U	1 U	1 U	3 U	--	--	
11/27/2006	102	1 U	1 U	1 U	3 U	--	--	
2/12/2007	352	1 U	1 U	1 U	3 U	--	--	
8/29/2007	190	1 U	1 U	1 U	3 U	--	--	
2/11/2008	271	1 U	1 U	1 U	3 U	--	--	
8/28/2008	314	1 U	1 U	1 U	3 U	--	--	
2/12/2009	239	1 U	1 U	1 U	3 U	--	--	
W-4	3/2/1990	--	7	17	7	15	--	--
W-5	3/2/1990	--	3.5	0.3 U	0.3 U	0.3 U	--	--
W-6	12/7/2000	3,400	0.2 U	0.2 U	1 U	8	--	--
	3/19/2001	3,400	0.39 J	20 U	3.2	27	--	--
	5/16/2001	710	0.2 U	2 U	0.5 J	3.5	--	--
	8/21/2001	2.2	1.1	7.3	0.2 U	0.6 U	--	--
	2/28/2002	120 J	1.7	1.2	0.4 J	3.5	--	--
	8/27/2002	850	1.8	0.2 U	2.5	3 U	--	--
	11/26/2002	2,300	1	1 U	1 U	10 U	--	--
	2/6/2003	400	3.3	0.6 J	0.89 J	2.7 J	--	--
	5/15/2003	400	4.7	1.7	9.4	11	--	--
	8/20/2003	530	1.4	1 U	1.9	3 U	--	--
	11/14/2003	700	12	7.9	14	39	--	--
	2/26/2004	150 J	1 U	2 U	1 U	3 J	--	--
	5/27/2004	380	5	7.2	18	35	--	--
	8/30/2004	220 J	0.9 J	0.3 J	1.6	2.2 J	--	--
11/18/2004	79 J	1.8	0.9 J	1.5	3.9	--	--	

**Table 6 Analytical Results for TPH as Gasoline, Benzene, Toluene, Ethylbenzene, Total Xylenes, and Lead in Groundwater**

Well ID	Date Sampled	TPH-Gas (µg/L)	Benzene (µg/L)	Ethylbenzene (µg/L)	Toluene (µg/L)	Total Xylene (µg/L)	Dissolved Lead (µg/L)	Total Lead (µg/L)
MTCA Method A Cleanup Level		1,000/800	5	700	1,000	1,000	15	15
W-6 (continued)	2/24/2005	230 J	0.8 J	1 U	0.9 J	3 J	--	--
	5/23/2005	<b>2,900</b>	<b>22</b>	53	170	300	--	--
	8/30/2005	190 J	1.2	0.2 U	0.7 J	0.6 U	--	--
	11/29/2005	48 U	0.2 U	0.2 U	0.2 U	0.6 U	--	--
	2/23/2006	48 U	0.2 U	0.2 U	0.2 U	0.6 U	--	--
	8/24/2006	100 U	1 U	1 U	2.33	3 U	--	--
	11/27/2006	670	1 U	1 U	1 U	3 U	--	--
	2/12/2007	<b>835</b>	1.28	1 U	1.32	3 U	--	--
	8/29/2007	603	1.03	1 U	1.08	3 U	--	--
	2/21/2008	372	1.18	1 U	1 U	3 U	--	--
	8/26/2008	1 U	1 U	1 U	1 U	3 U	--	--
2/12/2009	280	1 U	1 U	1 U	3 U	--	--	

Notes:

J = The result is an approximation

µg/L = microgram per liter

MTCA = Model Toxics Control Act

TPH = Total Petroleum Hydrocarbon

U = Analyte was not detected above the reporting limit indicated

UJ = Analyte was not detected above the reporting limit. Indicated value is estimated reporting limit.

-- = Not analyzed

**Bold and cell in orange** = Result greater than MTCA Method A cleanup level

**Bold and cell in yellow** = Analyte not detected, but reporting limit is greater than MTCA Method A cleanup level.

Table 7 Analytical Results for Polycyclic Aromatic Hydrocarbons in Groundwater

Well ID	Date Sampled	Acenaphthene (µg/L)	Acenaphthylene (µg/L)	Anthracene (µg/L)	Benzo(a)anthracene* (µg/L)	Benzo(a)pyrene* (µg/L)	Benzo(b)fluoranthene* (µg/L)	Benzo(g,h,i)perylene (µg/L)	Benzo(k)fluoranthene* (µg/L)	Chysene* (µg/L)	Dibenz(a,h)anthracene* (µg/L)	Fluoranthene (µg/L)	Fluorene (µg/L)	Indeno(1,2,3-cd)pyrene* (µg/L)	Naphthalene (µg/L)	Phenanthrene (µg/L)	Pyrene (µg/L)	cPAHs <sup>1</sup> (µg/L)
MTCA Method A Cleanup Level						0.1												0.1
MTCA Method B Cleanup Level Carcinogenic																	480	
MTCA Method B Cleanup Level Non-Carcinogenic		960		4,800											160			
B-2_well	12/1/1993	5 U	5 U	5 U	0.1 U	0.1 U	0.1 U	0.1 U	0.1 U	0.1 U	0.1 U	0.1 U	5 U	0.1 U	5 U	5 U	0.5 U	0.0755 U
	12/1/1995	5 U	5 U	5 U	0.1 U	0.1 U	0.1 U	0.1 U	0.1 U	0.1 U	0.1 U	0.1 U	5 U	0.1 U	5 U	5 U	0.5 U	0.0755 U
MW-6	12/1/1993	5 U	5 U	5 U	0.1 U	0.1 U	0.1 U	0.1 U	0.1 U	0.1 U	0.1 U	0.1 U	5 U	0.1 U	5 U	5 U	0.5 U	0.0755 U
MW-8	12/1/1993	1 U	1 U	1 U	0.1 U	0.1 U	0.1 U	0.1 U	0.1 U	0.1 U	0.1 U	0.1 U	1 U	0.1 U	1 U	1 U	0.5 U	0.0755 U
	12/1/1995	5 U	5 U	5 U	0.41	0.1 U	0.1 U	0.1 U	0.1 U	1.2	0.1 U	0.1 U	5 U	0.1 U	5 U	5 U	0.5 U	0.123
MW-9	12/1/1993	1 U	1 U	1 U	0.1 U	0.1 U	0.1 U	0.1 U	0.1 U	0.1 U	0.1 U	0.1 U	1 U	0.1 U	1 U	1 U	0.5 U	0.0755 U
	12/1/1995	5 U	5 U	5 U	0.1 U	0.1 U	0.1 U	0.1 U	0.1 U	0.1 U	0.1 U	0.1 U	5 U	0.1 U	5 U	5 U	0.5 U	0.0755 U
MW-10	12/1/1993	1 U	1 U	1 U	0.1 U	0.1 U	0.1 U	0.1 U	0.1 U	0.1 U	0.1 U	1.2	1 U	0.1 U	1 U	1 U	1.1	0.0755 U
	11/22/1995	5 U	5 U	5 U	0.65	0.29	0.15	0.19	0.1 U	3.7	0.28	1.5	5 U	0.1 U	5 U	5 U	1.6	0.445
	12/8/2000	8.1 U	9.9 J	2	2.75	2.07	1.73	2.1 J	0.58 J	10.3	0.3 U	5.7	5 J	2.36 J	8.1 U	13.1	19.2	2.93
	2/28/2002	3 J	2 J	0.4	0.1	0.1	0.1 J	0.2 J	0.05 J	0.08 U	0.04 U	0.8	1	0.1 J	1 U	2	1	0.1374
MW-11	12/1/1993	2.1	1 U	1.1	4.9	1.4	0.1 U	0.1 U	0.45	1.3	0.1 U	1.7	1.8	1	1 U	4.1	3.8	2.058
	12/8/2000	0.76 U	0.76 U	0.028 U	0.019 U	0.019 U	0.036 U	0.095 U	0.0095 U	0.057 U	0.028 U	0.028 U	0.16 U	0.063 U	0.76 U	0.068 U	0.16 U	0.01756
	3/19/2001	0.76 U	0.76 U	0.038 J	0.047 J	0.03 J	0.036 U	0.095 U	0.0095 U	0.057 U	0.028 U	0.082 J	0.16 U	0.063 U	0.76 U	0.095 J	0.16 U	0.04181
	5/16/2001	0.8 U	2.7 J	0.11 J	0.04 J	0.04 J	0.4 U	0.09 U	0.017 J	0.19 J	0.03 U	0.054 J	0.43 J	0.07 J	2.7 J	0.07 U	0.52 J	0.0761
	8/21/2001	0.8 U	0.8 U	0.03 U	0.05 J	0.04 J	0.04 U	0.09 U	0.01 J	0.16 J	0.03 U	0.03 U	0.2 U	0.06 U	0.8 U	0.07 U	0.2 U	0.0541
	2/28/2002	0.8 U	0.8 U	0.04 U	0.02 U	0.02 U	0.04 U	0.1 U	0.02 U	0.08 U	0.04 U	0.04 U	0.2 U	0.08 U	1 U	0.08 U	0.2 U	0.0204 U
MW-12	12/1/1993	5 U	5 U	5 U	0.1 U	0.1 U	0.1 U	0.1 U	0.1 U	0.1 U	0.1 U	0.11	5 U	0.1 U	5 U	5 U	0.5 U	0.0755 U
	11/22/1995	5 U	5 U	5 U	0.1 U	0.1 U	0.1 U	0.1 U	0.1 U	61	0.1 U	0.22	5 U	0.1 U	5 U	5 U	0.5 U	0.685
MW-13	12/1/1993	5 U	5 U	5 U	0.1 U	0.1 U	0.1 U	0.1 U	0.1 U	0.1 U	0.1 U	0.1 U	5 U	0.1 U	5 U	5 U	0.5 U	0.0755 U
	11/22/1995	5 U	5 U	5 U	0.76	2	1.4	2.2	0.72	2.5	0.83	2.2	5 U	1.2	5 U	5 U	2	2.516
MW-15	12/1/1993	5 U	5 U	5 U	0.1 U	0.1 U	0.1 U	0.1 U	0.1 U	0.1 U	0.1 U	0.1 U	5 U	0.1 U	5 U	5 U	0.5 U	0.0755 U
MW-16	12/1/1993	5 U	5 U	5 U	0.1 U	0.1 U	0.1 U	0.1 U	0.1 U	0.1 U	0.1 U	0.1 U	5 U	0.1 U	5 U	5 U	0.5 U	0.0755 U
MW-17	12/1/1993	5 U	5 U	5 U	0.1 U	0.1 U	0.1 U	0.1 U	0.1 U	0.1 U	0.1 U	0.1 U	5 U	0.1 U	5 U	5 U	0.5 U	0.0755 U
MW-18	12/1/1993	17	5 U	5 U	0.1 U	0.1 U	0.1 U	0.1 U	0.1 U	0.1 U	0.1 U	17	13	0.1 U	5 U	5 U	0.5 U	0.0755 U
	12/1/1995	8	5 U	5 U	7.4	0.1 U	0.1 U	0.1 U	0.1 U	20	0.1 U	13	13	0.1 U	7.2	23	9.2	1.01
	2/28/2002	1 J	3 J	0.3 U	0.03 J	0.04 J	0.04 U	0.1 U	0.02 U	0.08 U	0.04 U	0.3	0.5 J	0.08 U	1 U	0.4	0.8 U	0.0524
MW-19	12/7/2000	0.77 U	2.6 J	0.029 U	0.019 U	0.019 U	0.037 U	0.096 U	0.0096 U	0.123 J	0.029 U	0.029 U	0.16 U	0.064 U	0.77 U	0.067 U	0.16 U	0.01866
	3/19/2001	0.76 U	4.29 J	0.029 U	0.019 U	0.019 U	0.036 U	0.095 U	0.0095 U	0.057 U	0.029 U	0.029 U	0.27 J	0.064 U	0.79 J	0.067 U	0.16 U	0.01766 U
	5/16/2001	0.6 U	6.6 J	0.17 J	0.02 U	0.02 U	0.04 U	0.09 U	0.009 U	0.06 U	0.03 U	0.03 U	0.78 J	0.06 U	0.8 U	0.7 U	0.2 U	0.01825 U
	8/21/2001	0.8 U	0.8 U	0.03 U	0.02 U	0.02 U	0.04 U	0.09 U	0.009 U	0.06 U	0.03 U	0.03 U	0.21 J	0.06 U	0.8 U	0.06 U	0.2 U	0.01825 U
	2/28/2002	0.8 U	0.8 U	0.04 U	0.02 U	0.02 U	0.04 U	0.1 U	0.02 U	0.08 U	0.04 U	0.04 U	0.2 U	0.08 U	1 U	0.08 U	0.2 U	0.0204 U
MW-20	12/7/2000	1.3 J	2.53 J	0.159 J	0.02 U	0.02 U	0.037 U	0.098 U	0.0098 U	0.059 U	0.029 U	0.047 J	1.03	0.066 U	2.47 J	0.136 J	0.58 J	0.018385 U
	3/19/2001	0.76 U	0.76 U	0.19	0.019 U	0.019 U	0.036 U	0.095 U	0.0095 U	0.057 U	0.028 U	0.056 J	1.05	0.064 U	0.76 U	0.144 J	0.31 J	0.01761 U
	5/17/2001	0.9 J	2.3 J	0.3	0.02 J	0.02 J	0.04 U	0.1 U	0.01 J	0.06 U	0.035 J	0.16 J	1.3	0.073 J	0.8 U	0.35	1.4	0.0361
	2/28/2002	0.9 U	0.9 U	0.3	0.02 U	0.02 U	0.04 U	0.1 U	0.02 U	0.09 U	0.04 U	0.06 J	0.6 J	0.09 U	1 U	0.09 J	0.9 U	0.01995 U
MW-21	2/28/2002	4 U	4 U	5	2	0.9	2	0.5 U	0.3 J	12	0.3 J	1	6	0.9 J	5 U	7	1 U	1.57
MW-27	12/1/1995	5 U	5 U	5 U	2.1	0.1 U	0.1 U	0.1 U	0.1 U	0.8	0.1 U	1.4	5 U	0.1 U	5 U	5 U	1.5	0.288
MW-28	12/1/1993	5 U	5 U	5 U	0.1 U	0.1 U	0.1 U	0.1 U	0.1 U	0.1 U	0.1 U	0.1 U	5 U	0.1 U	5 U	5 U	0.5	0.0755 U
	12/1/1995	5 U	5 U	5 U	0.1 U	0.1 U	0.1 U	0.1 U	0.1 U	0.18	0.1 U	0.1 U	5 U	0.1 U	5 U	5 U	0.5 U	0.0768
MW-30	12/1/1993	5 U	5 U	5 U	0.1 U	0.1 U	0.1 U	0.1 U	0.1 U	0.1 U	0.1 U	0.1 U	5 U	0.1 U	5 U	5 U	0.5 U	0.0755 U
MW-35	12/8/2000	0.79 U	0.81 J	0.045 J	0.02 U	0.02 U	0.037 U	0.098 U	0.0098 U	0.294 J	0.031 J	0.029 U	0.17 U	0.066 U	0.79 U	0.069 U	0.17 U	0.02268
	3/19/2001	0.77 U	0.77 U	0.029 U	0.02 J	0.019 U	0.037 U	0.096 U	0.0096 U	0.064 J	0.029 U	0.029 U	0.16 U	0.064 U	0.77 U	0.067 U	0.16 U	0.01912
MW-37	11/22/1995	5 U	5 U	5 U	0.1 U	0.1 U	0.14	0.1 U	0.1 U	0.1 U	2.8	0.1 U	5 U	0.1 U	5 U	5 U	0.5 U	0.3595

Table 7 Analytical Results for Polycyclic Aromatic Hydrocarbons in Groundwater

Well ID	Date Sampled	Acenaphthene (µg/L)	Acenaphthylene (µg/L)	Anthracene (µg/L)	Benzo(a)anthracene* (µg/L)	Benzo(a)pyrene* (µg/L)	Benzo(b)fluoranthene* (µg/L)	Benzo(g,h,i)perylene (µg/L)	Benzo(k)fluoranthene* (µg/L)	Chysene* (µg/L)	Dibenz(a,h)anthracene* (µg/L)	Fluoranthene (µg/L)	Fluorene (µg/L)	Indeno(1,2,3-cd)pyrene* (µg/L)	Naphthalene (µg/L)	Phenanthrene (µg/L)	Pyrene (µg/L)	cPAHs <sup>1</sup> (µg/L)
MTCA Method A Cleanup Level						0.1												0.1
MTCA Method B Cleanup Level Carcinogenic																	480	
MTCA Method B Cleanup Level Non-Carcinogenic		960		4,800											160			
MW-40R	12/8/2000	3.8 U	27.3 J	0.6 J	0.45	<b>0.243 J</b>	0.18 U	0.48 U	0.048 U	1.9	0.14 U	0.73 J	4	0.4 J	4.4 J	2.9	6.4	<b>0.3654</b>
	3/19/2001	7.7 U	29.7 J	0.93 J	0.9	<b>0.33 J</b>	0.37 U	1 U	0.097 U	5.4	0.29 U	0.95 J	4.8 J	0.89 J	7.7 U	3.9	1.6 U	<b>0.60085</b>
	5/16/2001	4 U	21 J	0.76 J	0.1 U	<b>0.2 J</b>	0.2 U	0.5 J	0.08 J	0.3 U	0.1 U	1	5	0.63 J	4 J	2.1	13	<b>0.2925</b>
	8/21/2001	8 U	8 U	0.96 J	1.4	<b>0.6 J</b>	0.7	0.9 U	0.2 J	7.7	0.3 U	1.5 J	6.3 J	0.68 J	8 U	5.7	21	<b>0.99</b>
	2/28/2002	4 U	4 U	0.2 U	0.3 J	<b>0.3 J</b>	0.3 J	0.5 U	0.1 U	0.4 U	0.2 U	1	3 J	0.4 U	5 U	3	0.9 U	<b>0.397</b>
W-15R	2/28/2002	50 J	40 J	78	9	<b>5</b>	4	3 J	2	26	0.5 U	51	90	3 J	10 U	200	2 U	<b>7.085</b>
W-17	12/7/2000	4.6 J	5.6 J	2.2	2	<b>1.45</b>	0.97	1.1 J	0.4	8	0.14 U	4	6.5	1.28 J	3.8 U	14.4	27.9	<b>2.002</b>
	3/19/2001	7.9 U	7.9 U	4.3	3.74	<b>2.05</b>	1.63	1.4 J	0.473 J	21.8	0.3 U	5.8	10.1	0.66 U	7.9 U	25.5	58.8	<b>2.9003</b>
	5/16/2001	6 J	6 J	5	2.1	<b>1.7</b>	1.1	0.5 U	0.7	7.6	0.46 J	8	12	2.5	4 U	7	95	<b>2.462</b>
	8/21/2001	8 U	8 U	5	4.4	<b>2.1</b>	1.9	0.9 U	0.7	23	0.3 U	9	19	0.6 U	6 U	37	120	<b>3.075</b>
W-3	12/7/2000	1.2 J	6.79 J	0.191 J	0.02 U	0.02 U	0.038 U	0.1 U	0.01 U	0.06 U	0.03 U	0.03 U	0.76 J	0.067 U	1.29 J	0.071 J	0.17 U	0.01855 U
	3/19/2001	1.1 J	6.97 J	0.53	0.019 U	0.019 U	0.036 U	0.096 U	0.0096 U	0.057 U	0.029 U	0.029 J	1.44	0.064 U	1.35 J	0.067 U	0.16 U	0.017665 U
	5/17/2001	2.4 J	20	0.3	0.02 U	0.02 U	0.04 U	0.09 U	0.013 J	0.06 U	0.03 U	0.15	3.2	0.06 U	13	1	0.31	0.0191 U
	8/21/2001	0.9 J	0.8 U	0.03 U	0.02 U	0.02 U	0.04 U	0.09 U	0.009 U	0.06 U	0.03 U	0.03 U	0.9	0.06 U	1.2 J	0.06 U	0.2 U	0.01825 U
	3/1/2002	0.9 U	0.9 U	0.04 U	0.02 U	0.02 U	0.04 U	0.1 U	0.02 U	0.09 U	0.04 U	0.04 U	0.5 J	0.09 U	1 U	0.09 U	0.2 U	0.02095 U
W-6	12/7/2000	130 J	118 J	96	58.1	<b>32</b>	26.9	10 U	5.9 J	341	3 U	110	242	31	80 U	680	728	<b>47.75</b>
	3/19/2001	7.9 U	14 J	2.4	1.41	<b>0.74 J</b>	0.57 J	1 U	0.098 U	0.59 U	0.3 U	2.3	9.5	0.84 J	7.9 U	17.5	1.7 U	<b>1.04485</b>
	5/16/2001	4 U	4 U	0.26 J	0.2 J	<b>0.3 J</b>	0.26 J	0.5 U	0.14 J	0.6 J	0.16 J	0.58 J	0.8 U	0.82 J	4 U	0.49 J	12	<b>0.464</b>
	8/21/2001	8 U	8 U	0.34 J	1.1	<b>0.6 J</b>	0.7	0.9 U	0.26 J	7.2	0.3 U	0.58 J	2.6 J	0.86 J	6 U	1.9 J	22	<b>0.979</b>
	2/28/2002	4 U	4 U	0.2 U	0.2 J	<b>0.3 J</b>	0.4 J	0.5 U	0.1 J	0.4 U	0.2 U	0.5 J	0.9 U	0.8 J	5 U	0.8 J	0.9 U	<b>0.462</b>

Notes:

\*Compound is cPAH constituent included in TEQ-adjusted total cPAH concentrations. Values for individual cPAH constituents are actual analytical results.

1. Total cPAH concentration expressed as TEQ-adjusted concentration adjusted using Toxicity Equivalency Factors for Maximum Required cPAHs (Table 708-2 under WAC 173-340-708).

cPAH = carcinogenic polycyclic aromatic hydrocarbon

J = The result is an approximation

µg/L = microgram per liter

MTCA = Model Toxics Control Act

TEQ = toxicity-equivalent quotient

U = Analyte not detected above the reporting limit indicated

-- = Not analyzed

**Bold and cell in orange** = Result greater than MTCA Method A cleanup level.

Table 8 Statistical Summary of Soil Analytical Results

Parameter	CAS Number	Analyte	MTCA A Unrestricted (mg/kg)	MTCA A Industrial (mg/kg)	MTCA B Carcinogen (mg/kg)	MTCA B Noncarcinogen (mg/kg)	Indicator Hazardous Substance (yes/no)	Number Analyzed	Frequency of Detection (percent)	Maximum Detection Limit (mg/kg)	Minimum Detection Limit (mg/kg)	Maximum Result (mg/kg)	Minimum Result (mg/kg)	Average Result (mg/kg)	Number of Results Exceeding MTCA A Industrial	Number of Results Exceeding MTCA A Unrestricted	Number of Results Exceeding MTCA B Carcinogen	Number of Results Exceeding MTCA B Noncarcinogen
Metals	7439-92-1	Lead	250	1000			no	38	71	15	10	860	2.8	108	0	3	0	0
SVOCs	120-12-7	Anthracene				24,000	no	22	18	2	0.1	4.9	0.1	1.4	0	0	0	0
	129-00-0	Pyrene				2,400	no	22	32	2	0.02	1.35	0.0482	0.62	0	0	0	0
	191-24-2	Benzo(g,h,i)perylene					no	22	23	2	0.01	0.744	0.0728	0.31	0	0	0	0
	193-39-5	Indeno(1,2,3-cd)pyrene					no	22	27	2	0.1	1.43	0.0157	0.31	0	0	0	0
	205-99-2	Benzo(b)fluoranthene					no	22	27	2	0.1	0.468	0.0173	0.20	0	0	0	0
	206-44-0	Fluoranthene				3,200	no	22	36	2	0.1	1.75	0.019	0.52	0	0	0	0
	207-08-9	Benzo(k)fluoranthene					no	22	23	2	0.01	0.16	0.0365	0.097	0	0	0	0
	208-96-8	Acenaphthylene					no	22	14	2	0.1	2.98	0.168	1.4	0	0	0	0
	218-01-9	Chysene					no	22	27	2	0.1	25.2	0.0597	6.9	0	0	0	0
	50-32-8	Benzo(a)pyrene	0.1	2	0.14		yes	22	27	2	0.1	0.26	0.0106	0.10	0	3	2	0
	53-70-3	Dibenz(a,h)anthracene					no	22	14	2	0.01	0.409	0.0312	0.17	0	0	0	0
	56-55-3	Benzo(a)anthracene					no	22	23	2	0.01	4.25	0.0479	1.1	0	0	0	0
	83-32-9	Acenaphthene				4,800	no	22	9	2	0.1	1.27	0.32	0.80	0	0	0	0
	85-01-8	Phenanthrene					no	22	41	0.5	0.1	4.9	0.12	1.0	0	0	0	0
	86-73-7	Fluorene				3,200	no	22	18	2	0.1	3.52	0.17	1.6	0	0	0	0
91-20-3	Naphthalene				1,600	no	22	5	2	0.1	1.1	1.1	1.1	0	0	0	0	
91-20-3	cPAH <sup>1</sup>		0.1	2	0.14		yes	22	27	1.51	0.0755	0.6868	0.03818	0.33	0	4	4	0
Oil and Grease TPH	TPH_O&G	Oil and Grease					na	12	83	5	5	33,500	174	5,356	0	0	0	0
	TPH	TPH	2,000	2,000			yes	152	91	10	5	730,000	7	11,470	58	58	0	0
	TPH-D	TPH-Diesel	2,000	2,000			yes	67	82	10	2	27,100	7	1,627	11	11	0	0
	TPH-G	TPH-Gas	30	30			yes	50	50	50	1	6,050	1	632	17	17	0	0
	TPH-O	TPH-Oil	2,000	2,000			yes	37	76	471	25	52,300	41	2,438	3	3	0	0
VOC	71-43-2	Benzene	0	0			yes	80	30	34	0.01	15	0.04	2.70	3	3	0	0
	100-41-4	Ethylbenzene	6	6			no	80	15	8	0.01	5.3	0.02	0.90	0	0	0	0
	108-88-3	Toluene	7	7			no	80	26	30.5	0.015	12.975	0.26	4.07	4	4	0	0
	1330-20-7	Total Xylene	9	9			no	80	15	2.5	0.015	6.6	0.035	1.25	12	12	0	0

Notes:

1. Total cPAH concentration expressed as TEQ-adjusted concentration adjusted using Toxicity Equivalency Factors for Maximum Required cPAHs (Table 708-2 under WAC 173-340-708).

CAS = Chemical Abstract Service

cPAH = carcinogenic polycyclic aromatic hydrocarbons

mg/kg = microgram per kilogram

MTCA = Model Toxics Control Act

SVOC = Semivolatile Organic Compound

TPH = Total Petroleum Hydrocarbon

VOC = Volatile Organic Compound

**Table 9 Statistical Summary of Groundwater Analytical Results**

Parameter	CAS Number	Analyte	MTCA A Groundwater (µg/L)	MTCA B Carcinogen (µg/L)	MTCA B Noncarcinogen (µg/L)	Indicator Hazardous Substance (yes/no)	Number Analyzed	Frequency of Detection (percent)	Maximum Detection Limit	Minimum Detection Limit	Maximum Result (µg/L)	Minimum Result (µg/L)	Average Result (µg/L)	Number of Results Exceeding MTCA A	Number of Results Exceeding MTCA B Carcinogen	Number of Results Exceeding MTCA B Noncarcinogen
Metals	7439-92-1	Total Lead	15	--	--	no	20	100	--	--	230	10	65	17	--	--
	7439-92-1	Dissolved Lead	15	--	--	yes	20	75	2	2	12	2	4	0	--	--
SVOCs	120-12-7	Anthracene			4,800	no	64	44	5	0.028	96	0.028	4.9	0	0	0
	129-00-0	Pyrene			480	no	64	38	2	0.16	728	0.16	18.25	0	0	1
	191-24-2	Benzo(g,h,i)perylene				no	64	13	10	0.09	10	0.09	0.51	0	0	0
	193-39-5	Indeno(1,2,3-cd)pyrene				no	64	30	0.66	0.06	31	0.06	0.85	0	0	0
	205-99-2	Benzo(b)fluoranthene				no	64	28	0.4	0.036	26.9	0.036	0.77	0	0	0
	206-44-0	Fluoranthene			640	no	64	56	0.1	0.028	110	0.028	3.84	0	0	0
	207-08-9	Benzo(k)fluoranthene				no	64	31	0.1	0.009	5.9	0.009	0.248	0	0	0
	208-96-8	Acenaphthylene				no	64	33	8	0.76	118	0.76	7.7	0	0	0
	218-01-9	Chysene				no	64	41	0.59	0.057	341	0.057	8.9	0	0	0
	50-32-8	Benzo(a)pyrene	0.1			yes	64	41	0.1	0.019	32	0.019	0.89	20	0	0
	53-70-3	Dibenz(a,h)anthracene				no	64	13	3	0.028	3	0.028	0.22	0	0	0
	56-55-3	Benzo(a)anthracene				no	64	45	0.1	0.019	58.1	0.019	1.7	0	0	0
	83-32-9	Acenaphthene			960	no	64	23	8.1	0.6	130	0.6	6.46	0	0	0
	85-01-8	Phenanthrene				no	64	44	5	0.06	680	0.06	18.0	0	0	0
	86-73-7	Fluorene			640	no	64	52	5	0.16	242	0.16	8.8	0	0	0
91-20-3	Naphthalene			160	no	64	16	80	0.76	80	0.76	5.0	0	0	0	
		cPAH <sup>1</sup>	0.1		160	yes	64	56	0.0755	0.01761	47.75	0.01756	1.32	36	26	0
Oil and Grease TPH	TPH_O&G	Oil and Grease	na	--	--	na	12	100	--	--	132,000	2,700	31,150	12	--	--
	TPH	TPH	500	--	--	yes	56	66	1,000	500	1,058,000	1.1	38,955	0	--	--
	TPH-D	TPH-Diesel	500	--	--	yes	232	93	500	77	300,000	20	7,951	181	--	--
	TPH-G	TPH-Gas	800	--	--	yes	231	69	500	1	5,980	1	671	59	--	--
	TPH-O	TPH-Oil	500	--	--	yes	181	86	500,000	93.9	500,000	49	6,782	108	--	--
VOC	71-43-2	Benzene	5	--	--	yes	286	50	10	0.2	1,100	0.2	37.30	73	--	--
	100-41-4	Ethylbenzene	700	--	--	no	286	33	20	0.2	359	0.2	6.15	0	--	--
	108-88-3	Toluene	1000	--	--	no	286	43	7.45	0.2	351	0.2	7.47	0	--	--
	1330-20-7	Total Xylene	1000	--	--	no	286	50	31	0.3	1,941	0.3	26.7	2	--	--

Notes:

1. Total cPAH concentration expressed as TEQ-adjusted concentration adjusted using Toxicity Equivalency Factors for Maximum Required cPAHs (Table 708-2 under WAC 173-340-708).

CAS = Chemical Abstract Service

cPAH = carcinogenic polycyclic aromatic hydrocarbon

µg/L = microgram per liter

MTCA = Model Toxics Control Act

na = not available

SVOC = Semivolatile Organic Compound

TPH = Total Petroleum Hydrocarbon

VOC = Volatile Organic Compound

## FIGURES

JOB NO.: 9-915-15716-C DWG DATE: 3-27-2009 10:50am SCALE: 1"=60' DESIGN BY: JRS FILE NAME: 15716-C-01.dwg

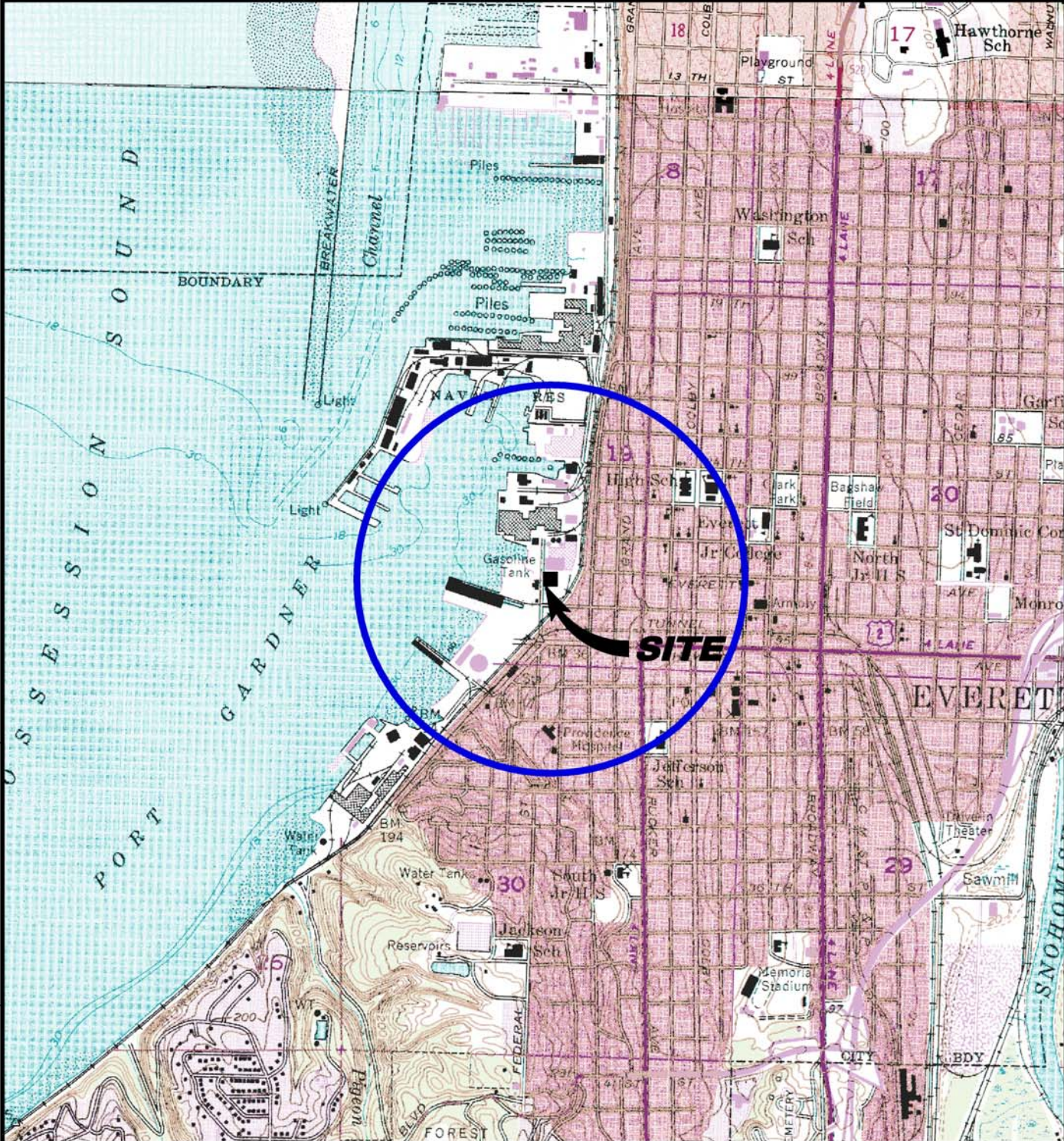

**EXPLANATION**

 1/2-MILE RADIUS CIRCLE



0 2000 4000 Feet

SCALE: 1:24,000

SOURCE: USGS Quad Topo of Everett and Marysville, Photorevised 1973.

**amec**  
 AMEC EARTH & ENVIRONMENTAL, INC.  
 11810 North Creek Parkway North  
 Bothell, WA, U.S.A. 98011-8201

**SITE LOCATION MAP**  
 EXXONMOBIL/ADC PROPERTY, ECOLOGY SITE ID 2728  
 2717/2731 FEDERAL AVENUE  
 EVERETT, WASHINGTON

**FIGURE**  
**1**



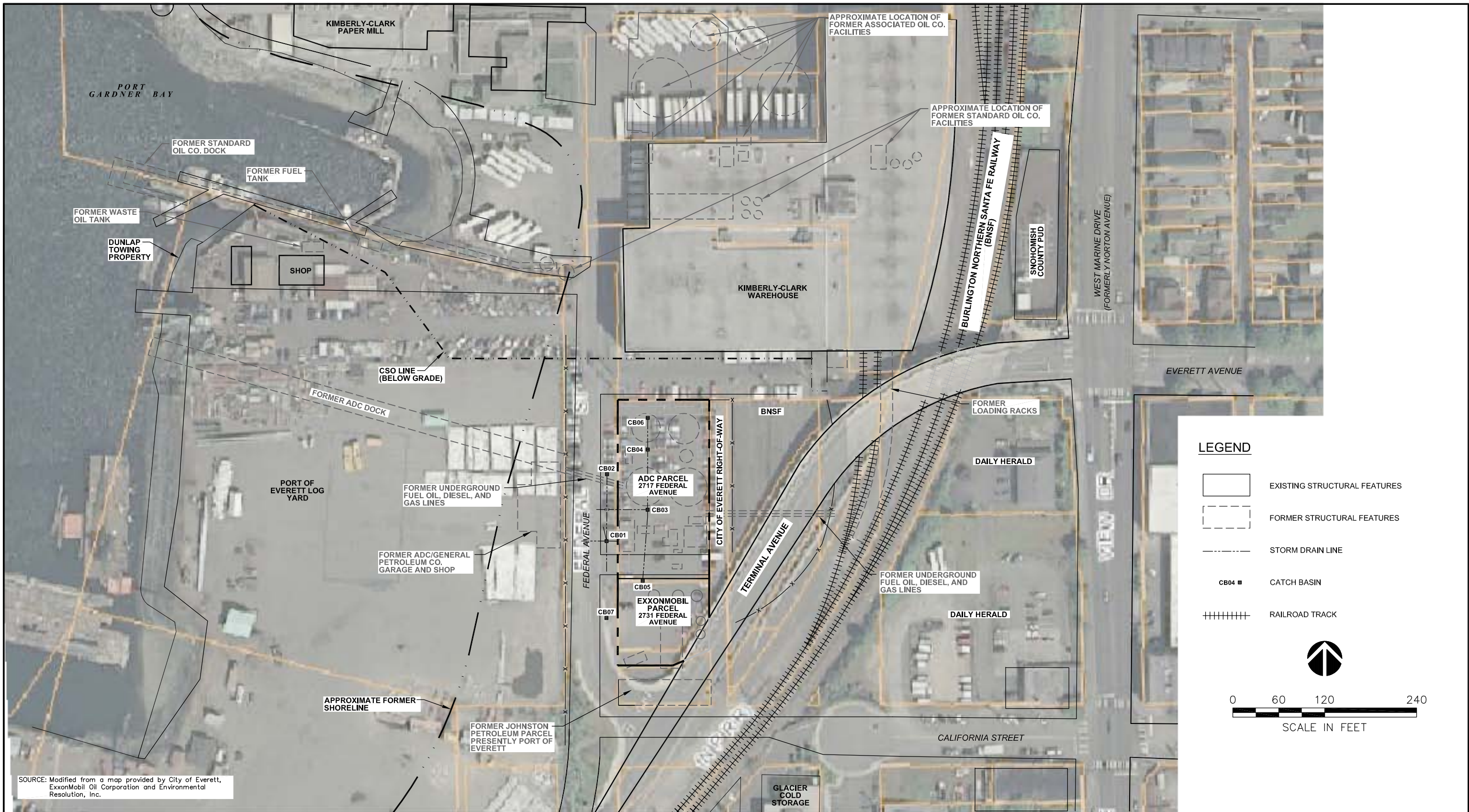

SOURCE: Modified from a map provided by City of Everett, ExxonMobil Oil Corporation and Environmental Resolution, Inc.

CLIENT LOGO	CLIENT:	EXXONMOBIL AND AMERICAN DISTRIBUTING COMPANY		DWN BY:	JRS	PROJECT	EXXONMOBIL/ADC PROPERTY	DATE:	FENRUARY 2010
				CHK'D BY:	AS			ECOLOGY SITE ID 2728	PROJECT NO.:
				DATUM:	NONE	TITLE	PLAN OF THE PROPERTY AND VICINITY	REV. NO.:	
				PROJECTION:	NONE			FIGURE No.	2
				SCALE:	AS SHOWN				
		CLIENT:	AMEC Earth & Environmental 11810 North Creek Parkway North Bothell, WA, U.S.A. 98011-8201						

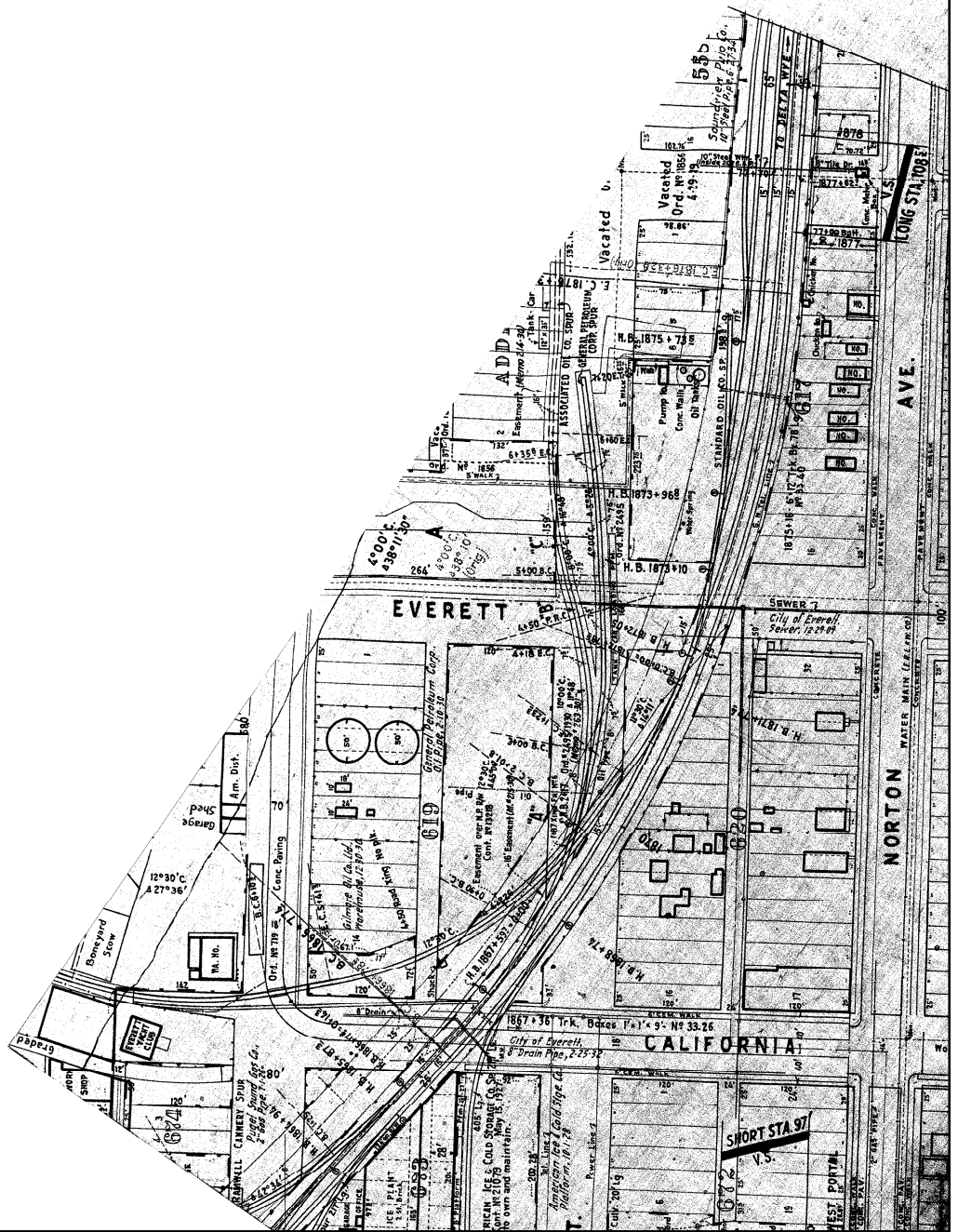

Note:  
 Parcels layer from Snohomish County, ftp://ftp.snoco.org  
 2003 aerial from Washington Department of Transportation

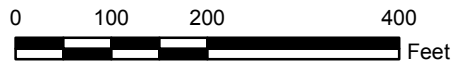

**AMEC Earth & Environmental**  
 11820 North Creek Parkway North  
 Bothell, Washington 98011



CLIENT:

**EXXONMOBIL  
 AND AMERICAN  
 DISTRIBUTING CO.**

PROJECT: **EXXONMOBIL/ADC PROPERTY  
 ECOLOGY SITE ID 2728**



DWN BY: BRJ      DATUM: NAD83      DATE: AUGUST 2009

CHKD BY: AIS/MS      REV. NO.: 1      PROJECT NO.: 9-915-15716C

TITLE: **1930 GREAT NORTHERN RAILWAY EVERETT MAP**

PROJECTION: WA SP North      SCALE: 1 inch = 200 feet      FIGURE No.: **FIGURE 3**

# LEGEND

-  Above Ground Tanks (ASTs) in 1930 Map
-  Buildings in 1930 Map
-  Taxlot Parcels

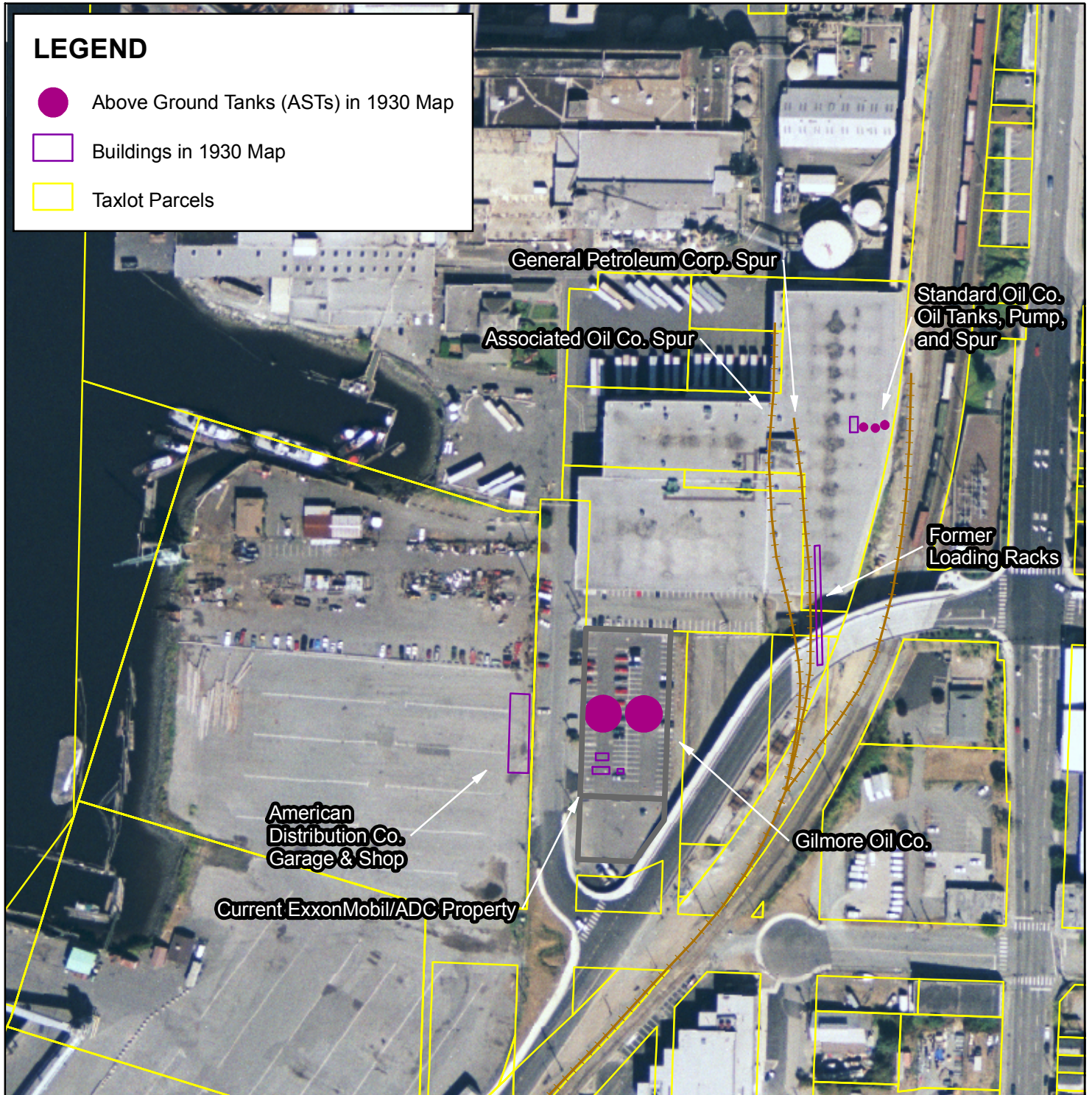

**Note:**  
 Parcels layer from Snohomish County, <ftp://ftp.snoco.org>  
 2003 aerial from Washington Department of Transportation

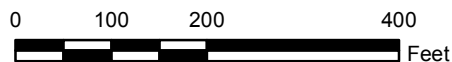

**AMEC Earth & Environmental**  
 11820 North Creek Parkway North  
 Bothell, Washington 98011



CLIENT:  
**EXXONMOBIL  
 AND AMERICAN  
 DISTRIBUTING CO.**

PROJECT: **EXXONMOBIL/ADC PROPERTY  
 ECOLOGY SITE ID 2728**

DWN BY: BRJ      DATUM: NAD83      DATE: AUGUST 2009

CHKD BY: AIS/MS      REV. NO.: 1      PROJECT NO.: 9-915-15716C

TITLE: **FEATURES SEEN IN  
 1930 GREAT NORTHERN RAILWAY EVERETT MAP  
 OVER 2003 AERIAL**

PROJECTION: WA SP North      SCALE: 1 inch = 200 feet      FIGURE No.: **FIGURE 4**



**Note:**  
 Parcels layer from Snohomish County, ftp://ftp.snoco.org  
 2003 aerial from Washington Department of Transportation

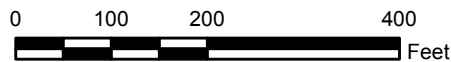

**AMEC Earth & Environmental**  
 11820 North Creek Parkway North  
 Bothell, Washington 98011



CLIENT:

**EXXONMOBIL  
 AND AMERICAN  
 DISTRIBUTING CO.**

PROJECT: **EXXONMOBIL/ADC PROPERTY  
 ECOLOGY SITE ID 2728**

DWN BY: BRJ	DATUM: NAD83	DATE: AUGUST 2009
----------------	-----------------	----------------------

CHK'D BY: AIS/MS	REV. NO.: 1	PROJECT NO.: 9-915-15716C
---------------------	----------------	------------------------------

TITLE: **AERIAL 1947**

PROJECTION: WA SP North	SCALE: 1 inch = 200 feet	FIGURE No.: <b>FIGURE 5</b>
----------------------------	-----------------------------	--------------------------------

# LEGEND

- Above Ground Tanks (ASTs) in 1947 Aerial
- Buildings in 1947 Aerial
- Taxlot Parcels

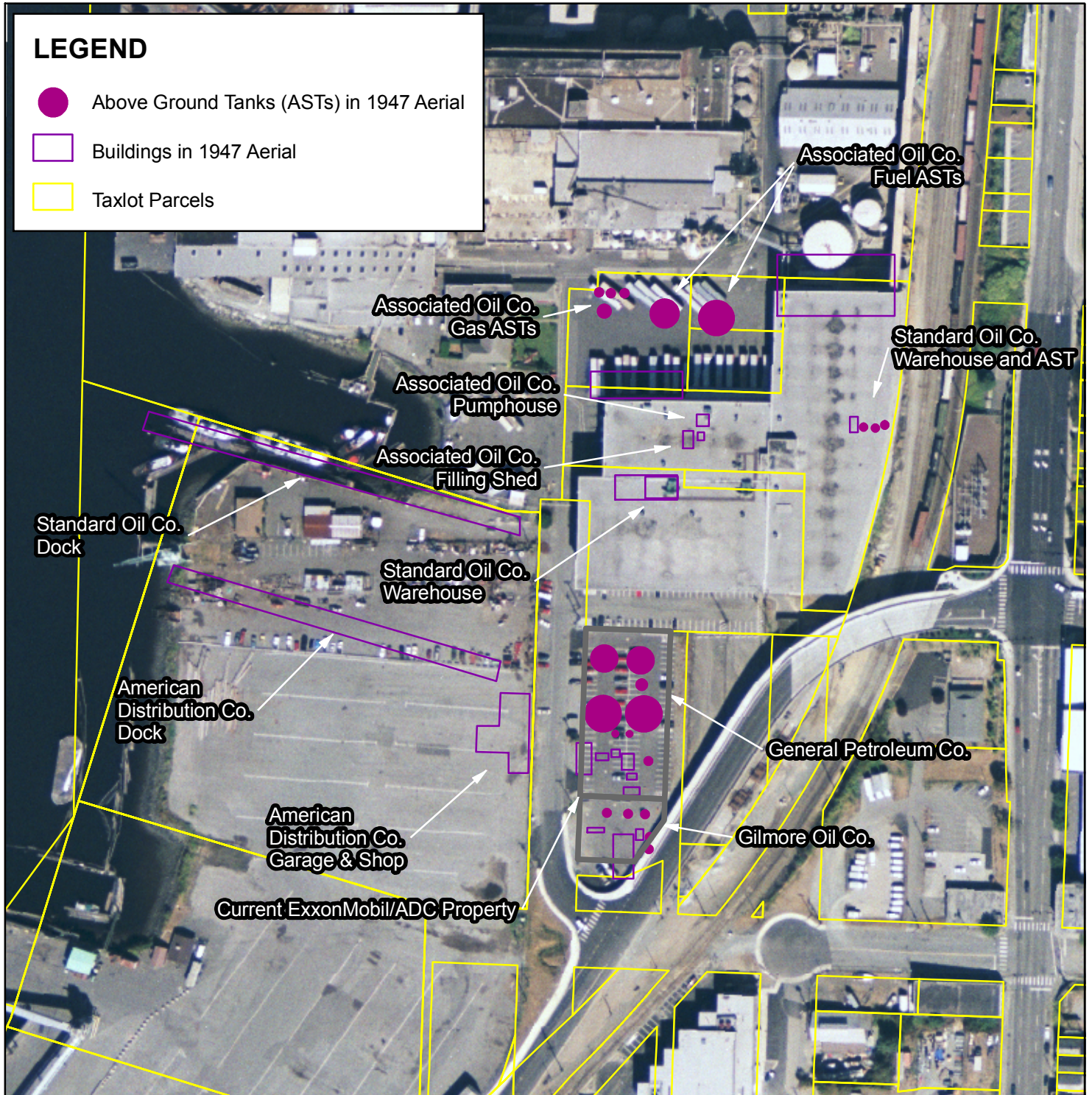

**Note:**  
 Parcels layer from Snohomish County, <ftp://ftp.snoco.org>  
 2003 aerial from Washington Department of Transportation

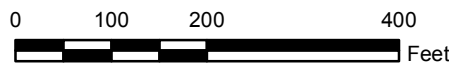

**AMEC Earth & Environmental**  
 11820 North Creek Parkway North  
 Bothell, Washington 98011



**CLIENT:**  
**EXXONMOBIL AND AMERICAN DISTRIBUTING CO.**

**PROJECT:** EXXONMOBIL/ADC PROPERTY  
 ECOLOGY SITE ID 2728

**DWN BY:** BRJ **DATUM:** NAD83 **DATE:** AUGUST 2009

**CHKD BY:** AIS/MS **REV. NO.:** 1 **PROJECT NO.:** 9-915-15716C

**TITLE:** FEATURES SEEN IN  
 1947 AERIAL  
 OVER 2003 AERIAL

**PROJECTION:** WA SP North **SCALE:** 1 inch = 200 feet **FIGURE No.:** FIGURE 6

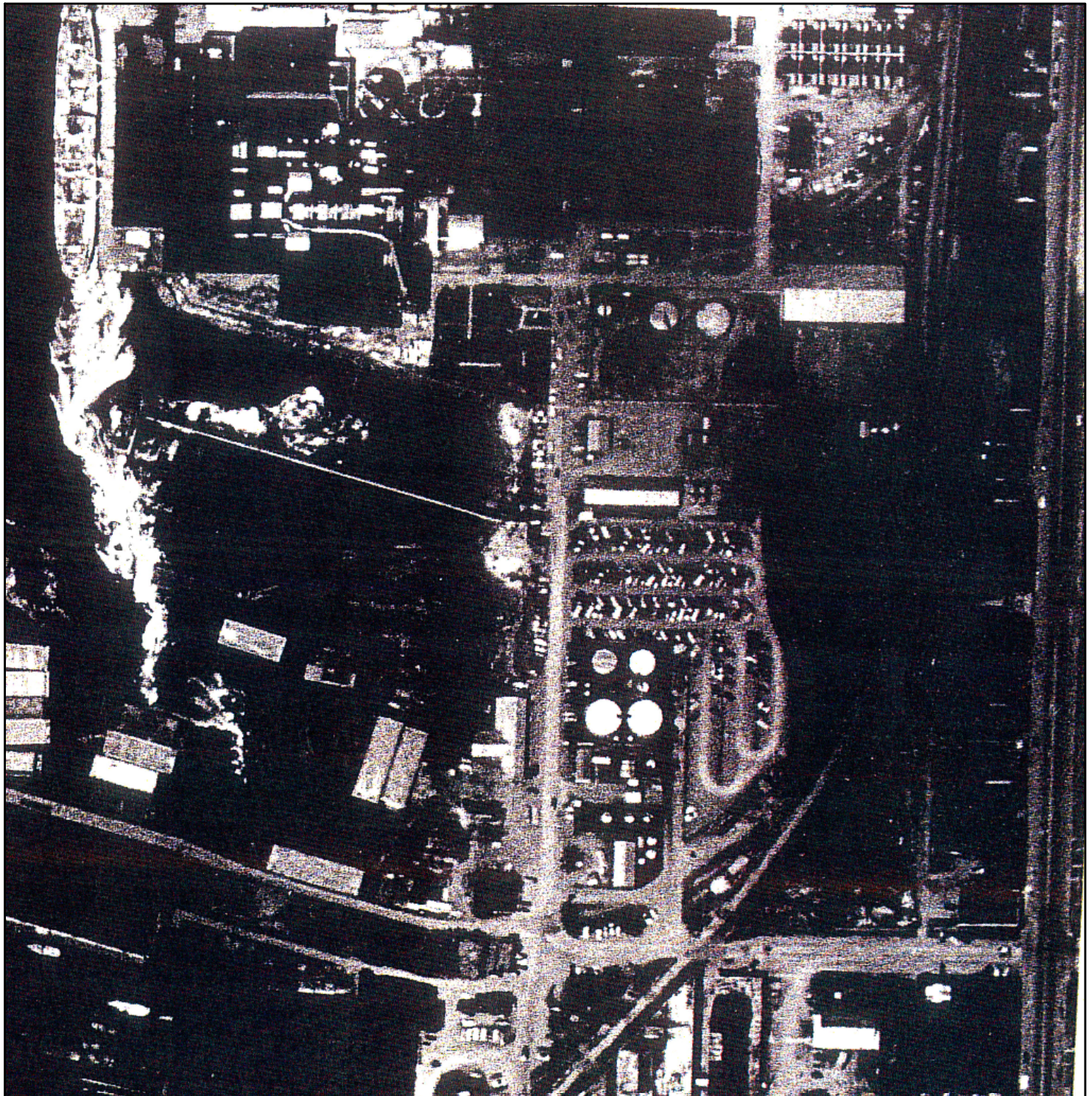

**Note:**  
 Parcels layer from Snohomish County, <ftp://ftp.snoco.org>  
 2003 aerial from Washington Department of Transportation

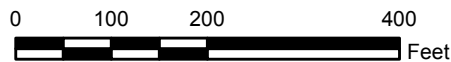

**AMEC Earth & Environmental**  
 11820 North Creek Parkway North  
 Bothell, Washington 98011



CLIENT:

**EXXONMOBIL  
 AND AMERICAN  
 DISTRIBUTING CO.**

PROJECT: **EXXONMOBIL/ADC PROPERTY  
 ECOLOGY SITE ID 2728**

DWN BY: BRJ

DATUM: NAD83

DATE: AUGUST 2009

CHK'D BY: AIS/MS

REV. NO.: 1

PROJECT NO.: 9-915-15716C

TITLE: **AERIAL 1955**

PROJECTION: WA SP North

SCALE: 1 inch = 200 feet

FIGURE No.: **FIGURE 7**

# LEGEND

- Above Ground Tanks (ASTs) in 1955 Aerial
- Buildings in 1955 Aerial
- Taxlot Parcels

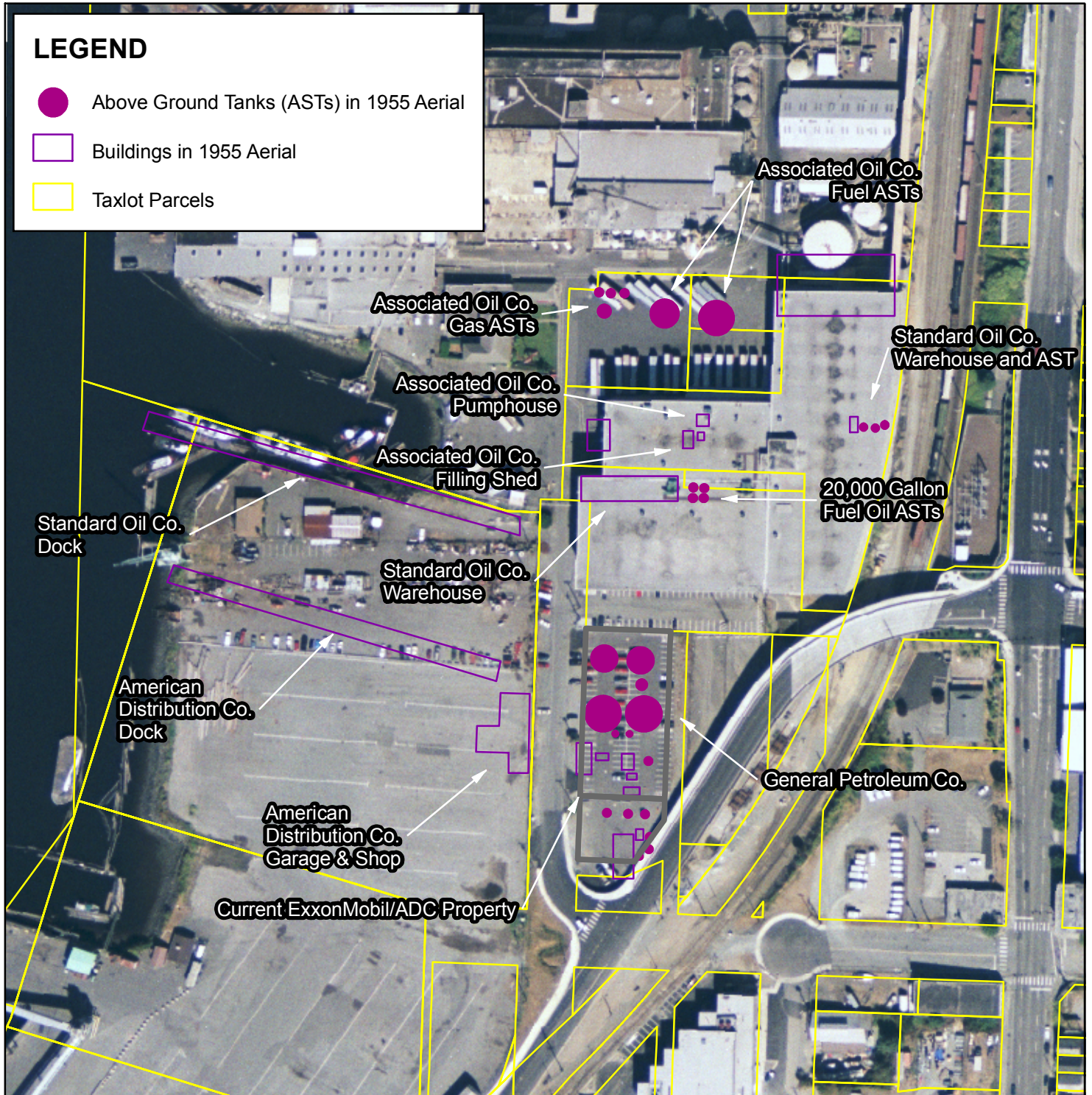

**Note:**  
 Parcels layer from Snohomish County, <ftp://ftp.snoco.org>  
 2003 aerial from Washington Department of Transportation

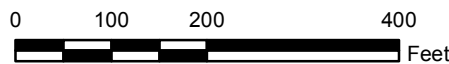

<b>AMEC Earth &amp; Environmental</b> 11820 North Creek Parkway North Bothell, Washington 98011				CLIENT: <b>EXXONMOBIL AND AMERICAN DISTRIBUTING CO.</b>	
PROJECT: <b>EXXONMOBIL/ADC PROPERTY ECOLOGY SITE ID 2728</b>		DWN BY: BRJ	DATUM: NAD83	DATE: AUGUST 2009	
TITLE: <b>FEATURES SEEN IN 1955 AERIAL OVER 2003 AERIAL</b>		CHKD BY: AIS/MS	REV. NO.: 1	PROJECT NO.: 9-915-15716C	
		PROJECTION: WA SP North	SCALE: 1 inch = 200 feet	FIGURE No.: <b>FIGURE 8</b>	

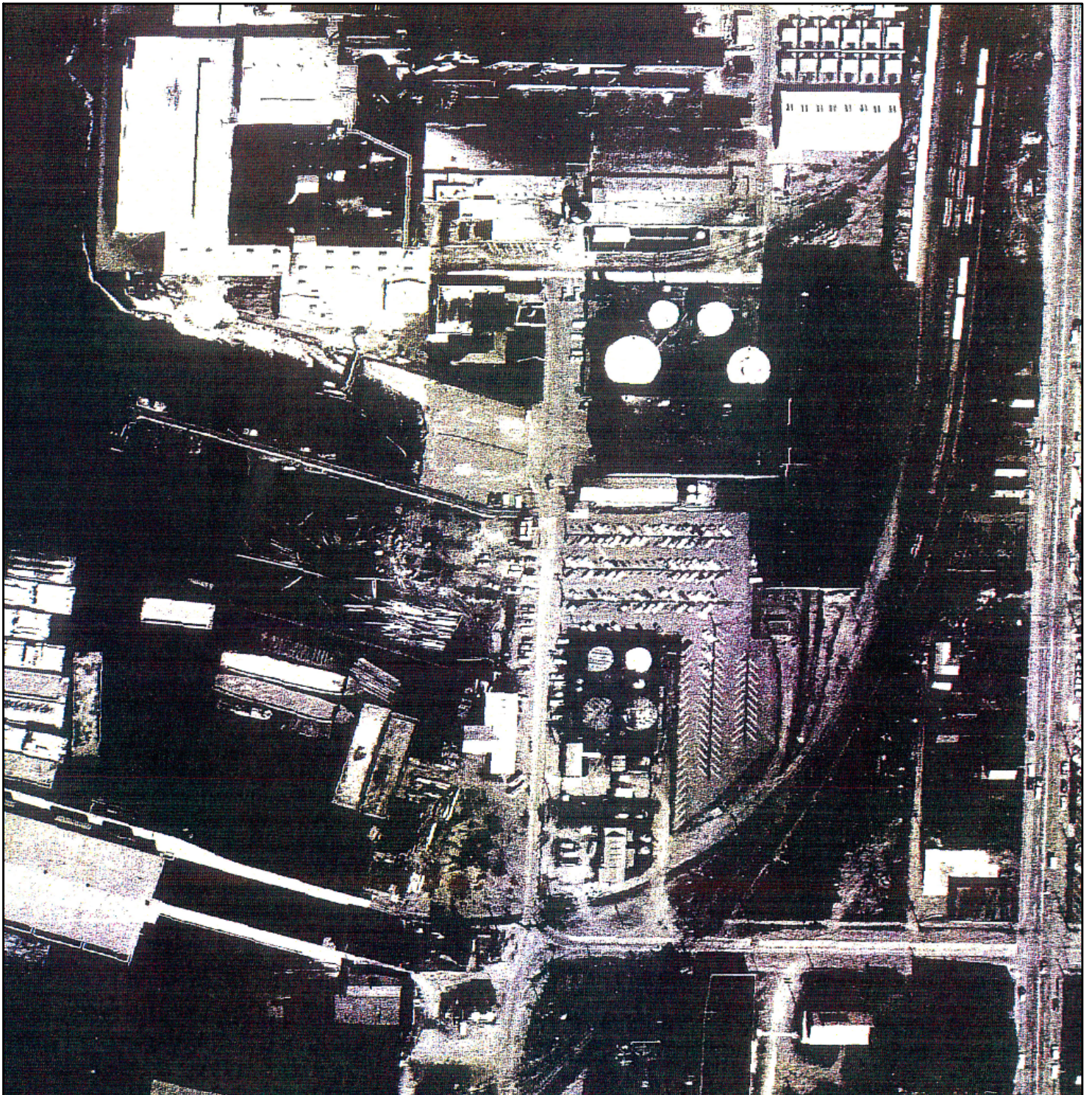

**Note:**  
 Parcels layer from Snohomish County, <ftp://ftp.snoco.org>  
 2003 aerial from Washington Department of Transportation

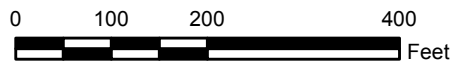

**AMEC Earth & Environmental**  
 11820 North Creek Parkway North  
 Bothell, Washington 98011



CLIENT:

**EXXONMOBIL  
 AND AMERICAN  
 DISTRIBUTING CO.**

PROJECT: **EXXONMOBIL/ADC PROPERTY  
 ECOLOGY SITE ID 2728**

DWN BY: BRJ	DATUM: NAD83	DATE: AUGUST 2009
----------------	-----------------	----------------------

CHK'D BY: AIS/MS	REV. NO.: 1	PROJECT NO.: 9-915-15716C
---------------------	----------------	------------------------------

TITLE: **AERIAL 1967**

PROJECTION: WA SP North	SCALE: 1 inch = 200 feet	FIGURE No.: <b>FIGURE 9</b>
----------------------------	-----------------------------	--------------------------------



# LEGEND

- Above Ground Tanks (ASTs) in 1967 Aerial
- Buildings in 1967 Aerial
- Taxlot Parcels

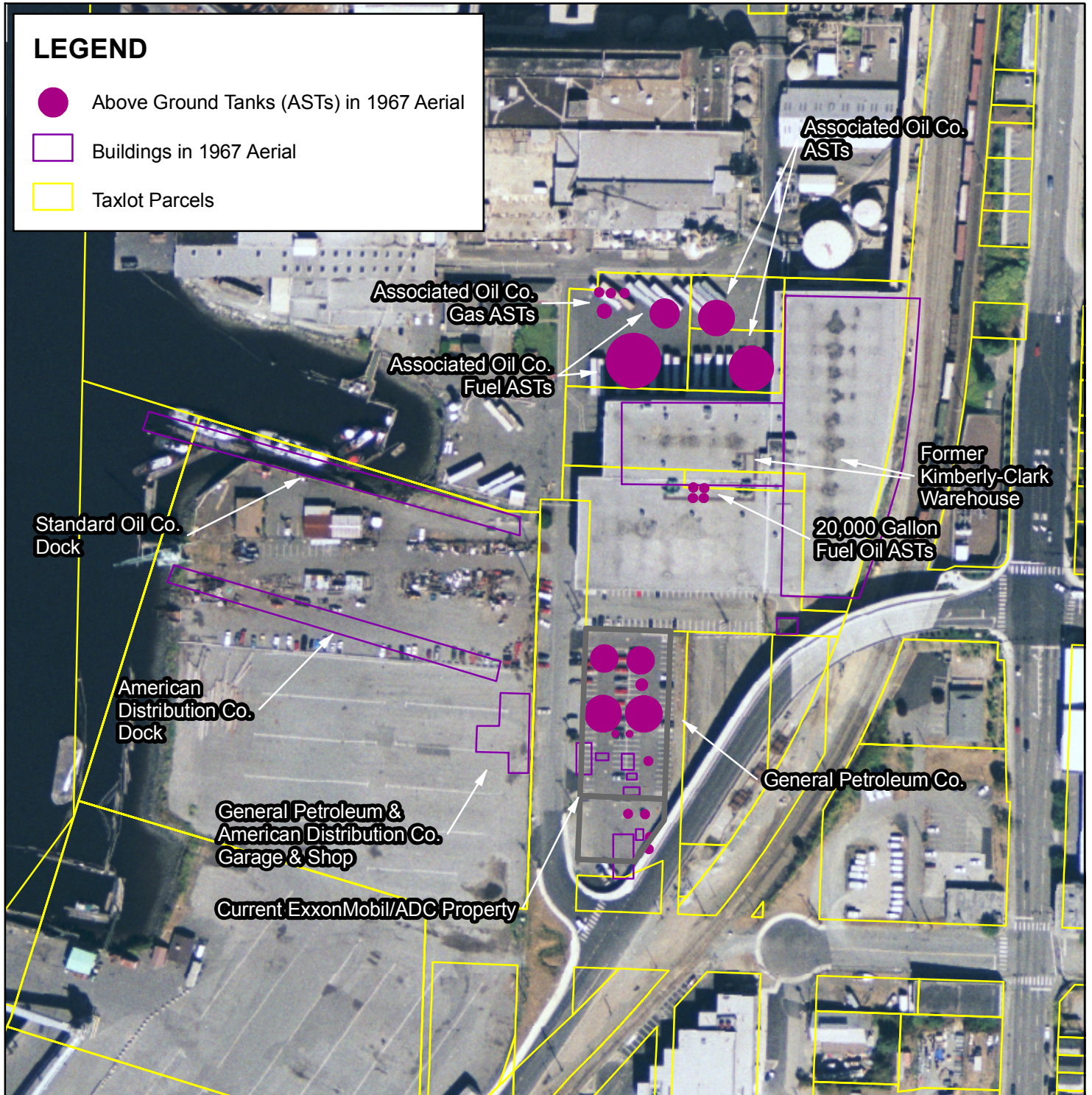

**Note:**  
 Parcels layer from Snohomish County, <ftp://ftp.snoco.org>  
 2003 aerial from Washington Department of Transportation

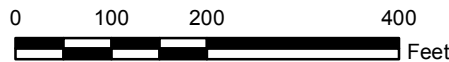

<b>AMEC Earth &amp; Environmental</b> 11820 North Creek Parkway North Bothell, Washington 98011				CLIENT: <b>EXXONMOBIL AND AMERICAN DISTRIBUTING CO.</b>	
PROJECT: <b>EXXONMOBIL/ADC PROPERTY ECOLOGY SITE ID 2728</b>		DWN BY: BRJ	DATUM: NAD83	DATE: AUGUST 2009	
TITLE: <b>FEATURES SEEN IN 1967 AERIAL OVER 2003 AERIAL</b>		CHKD BY: AIS/MS	REV. NO.: 1	PROJECT NO.: 9-915-15716C	
		PROJECTION: WA SP North	SCALE: 1 inch = 200 feet	FIGURE No.: <b>FIGURE 10</b>	

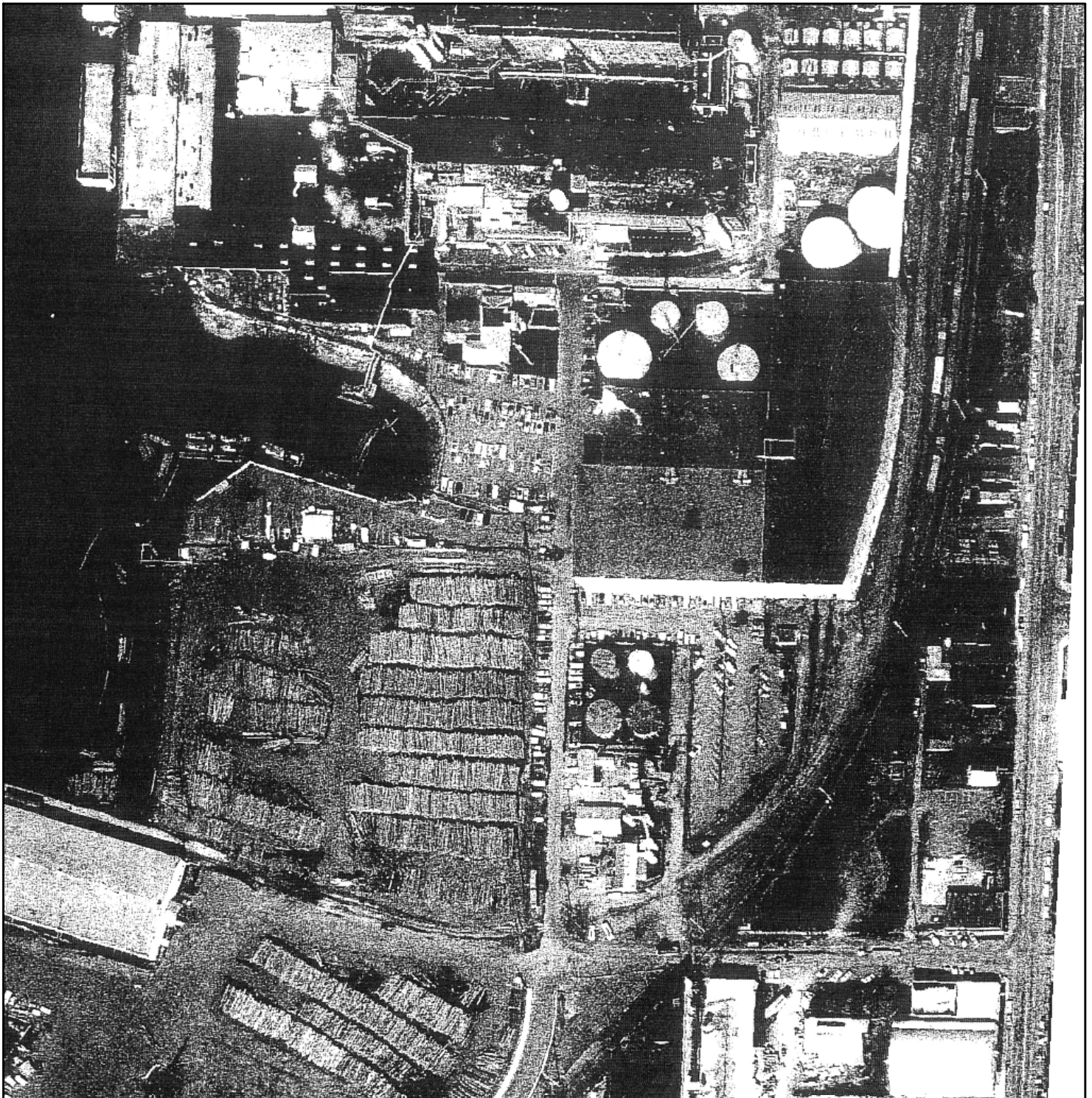

**Note:**  
 Parcels layer from Snohomish County, ftp://ftp.snoco.org  
 2003 aerial from Washington Department of Transportation

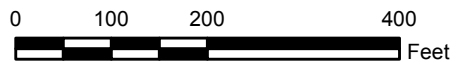

**AMEC Earth & Environmental**  
 11820 North Creek Parkway North  
 Bothell, Washington 98011



CLIENT:

**EXXONMOBIL  
 AND AMERICAN  
 DISTRIBUTING CO.**

PROJECT: **EXXONMOBIL/ADC PROPERTY  
 ECOLOGY SITE ID 2728**

DWN BY: BRJ	DATUM: NAD83	DATE: AUGUST 2009
----------------	-----------------	----------------------

CHK'D BY: AIS/MS	REV. NO.: 1	PROJECT NO.: 9-915-15716C
---------------------	----------------	------------------------------

TITLE: **AERIAL 1976**

PROJECTION: WA SP North	SCALE: 1 inch = 200 feet	FIGURE No.: FIGURE 11
----------------------------	-----------------------------	--------------------------

# LEGEND

- Above Ground Tanks (ASTs) in 1976 Aerial
- Buildings in 1976 Aerial
- Taxlot Parcels

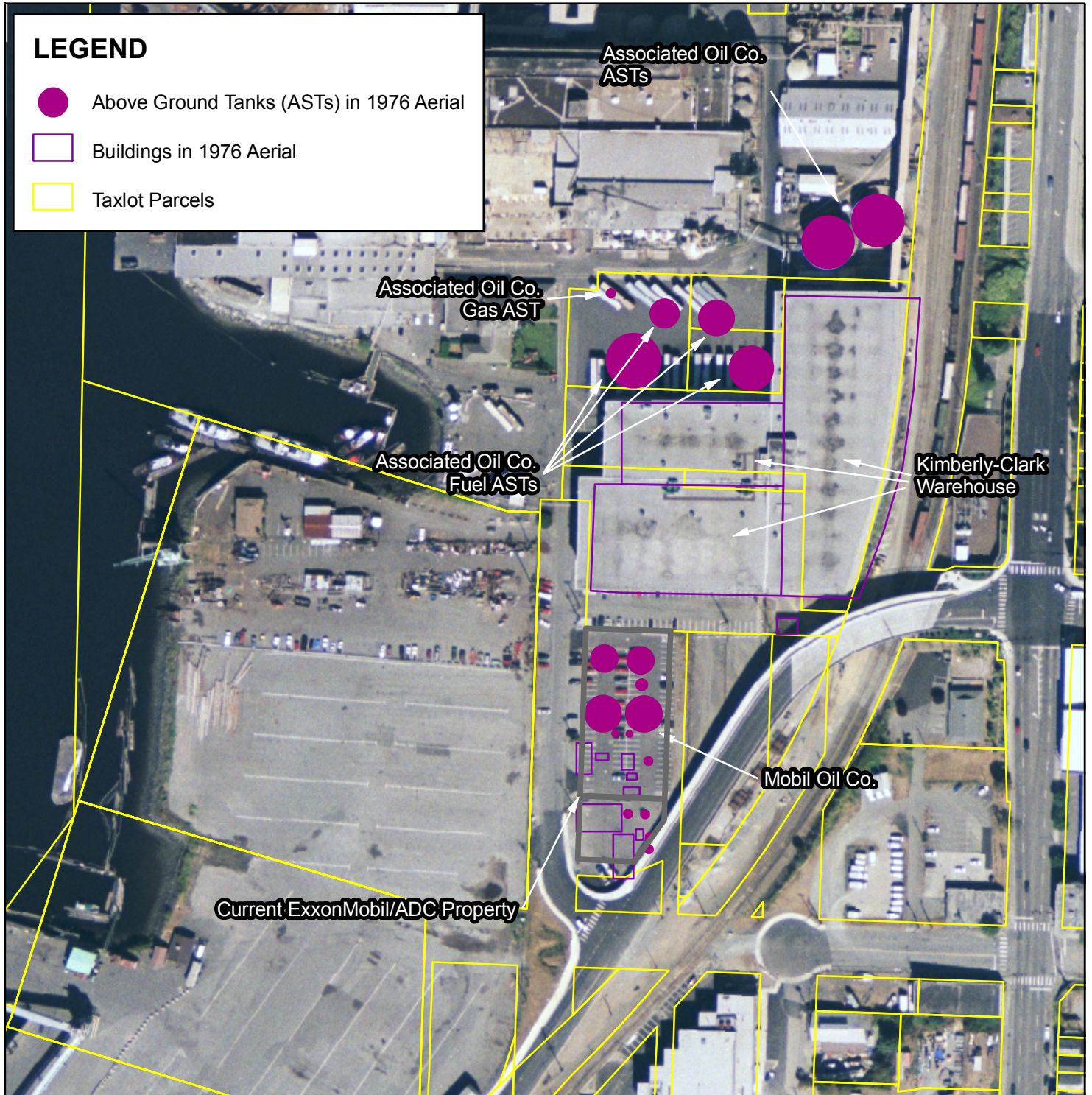

**Note:**  
 Parcels layer from Snohomish County, <ftp://ftp.snoco.org>  
 2003 aerial from Washington Department of Transportation

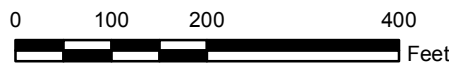

**AMEC Earth & Environmental**  
 11820 North Creek Parkway North  
 Bothell, Washington 98011



CLIENT:  
**EXXONMOBIL  
 AND AMERICAN  
 DISTRIBUTING CO.**

PROJECT: **EXXONMOBIL/ADC PROPERTY  
 ECOLOGY SITE ID 2728**

DWN BY: BRJ      DATUM: NAD83      DATE: AUGUST 2009

CHKD BY: AIS/MS      REV. NO.: 1      PROJECT NO.: 9-915-15716C

TITLE: **FEATURES SEEN IN  
 1976 AERIAL  
 OVER 2003 AERIAL**

PROJECTION: WA SP North      SCALE: 1 inch = 200 feet      FIGURE No.: **FIGURE 12**



**Note:**  
 Parcels layer from Snohomish County, <ftp://ftp.snoco.org>  
 2003 aerial from Washington Department of Transportation

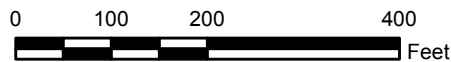

**AMEC Earth & Environmental**  
 11820 North Creek Parkway North  
 Bothell, Washington 98011



CLIENT:

**EXXONMOBIL  
 AND AMERICAN  
 DISTRIBUTING CO.**

PROJECT: **EXXONMOBIL/ADC PROPERTY  
 ECOLOGY SITE ID 2728**



DWN BY: BRJ	DATUM: NAD83	DATE: AUGUST 2009
----------------	-----------------	----------------------

CHK'D BY: AIS/MS	REV. NO.: 1	PROJECT NO.: 9-915-15716C
---------------------	----------------	------------------------------

TITLE: **AERIAL 1993**

PROJECTION: WA SP North	SCALE: 1 inch = 200 feet	FIGURE No.: FIGURE 13
----------------------------	-----------------------------	--------------------------

# LEGEND

-  Above Ground Tanks (ASTs) in 1993 Aerial
-  Buildings in 1993 Aerial
-  Taxlot Parcels

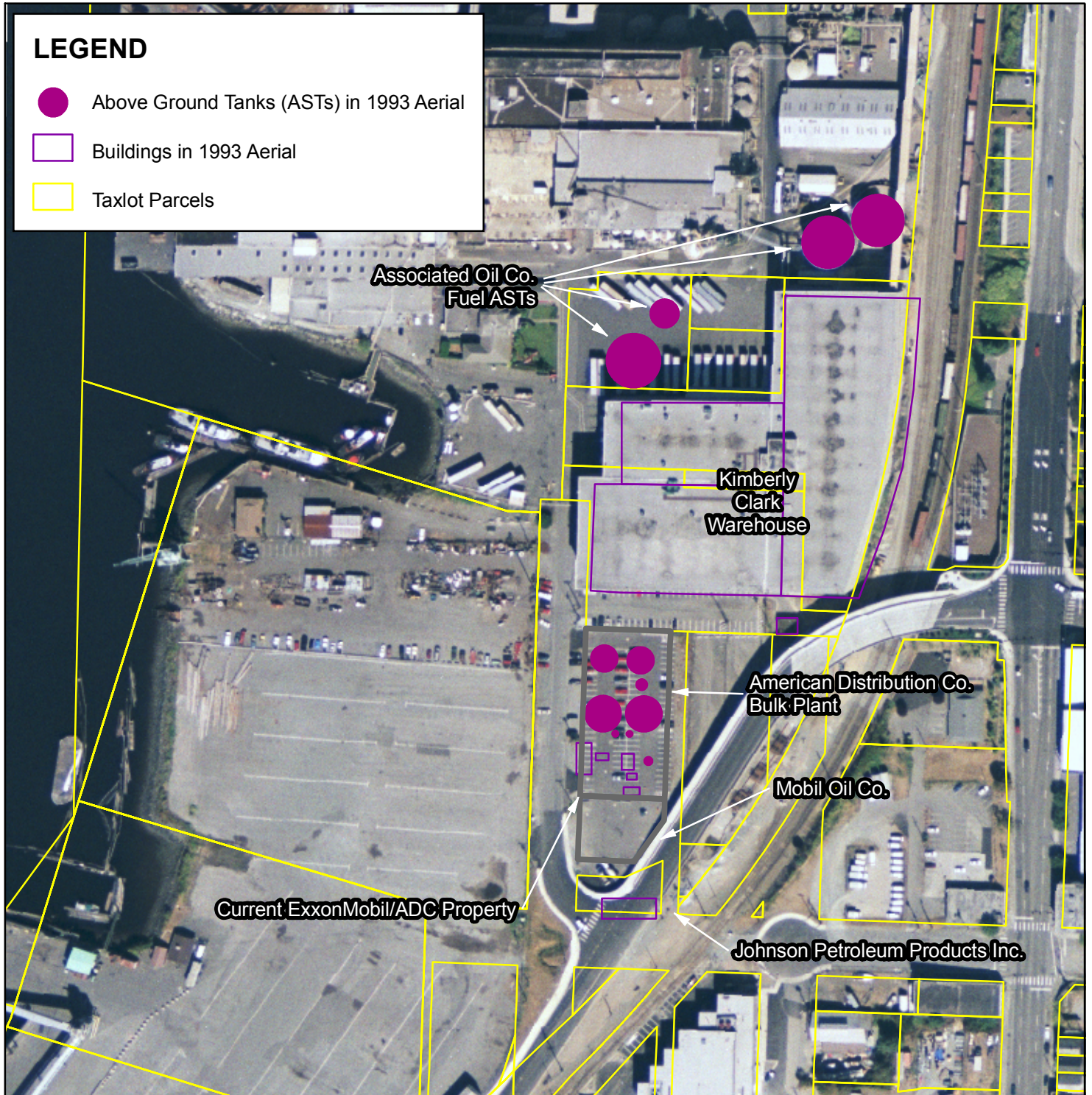

**Note:**  
 Parcels layer from Snohomish County, <ftp://ftp.snoco.org>  
 2003 aerial from Washington Department of Transportation

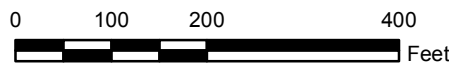

**AMEC Earth & Environmental**  
 11820 North Creek Parkway North  
 Bothell, Washington 98011



CLIENT:  
**EXXONMOBIL  
 AND AMERICAN  
 DISTRIBUTING CO.**

PROJECT: **EXXONMOBIL/ADC PROPERTY  
 ECOLOGY SITE ID 2728**

DWN BY: BRJ      DATUM: NAD83      DATE: AUGUST 2009

CHKD BY: AIS/MS      REV. NO.: 1      PROJECT NO.: 9-915-15716C

TITLE: **FEATURES SEEN IN  
 1993 AERIAL  
 OVER 2003 AERIAL**

PROJECTION: WA SP North      SCALE: 1 inch = 200 feet      FIGURE No.: **FIGURE 14**

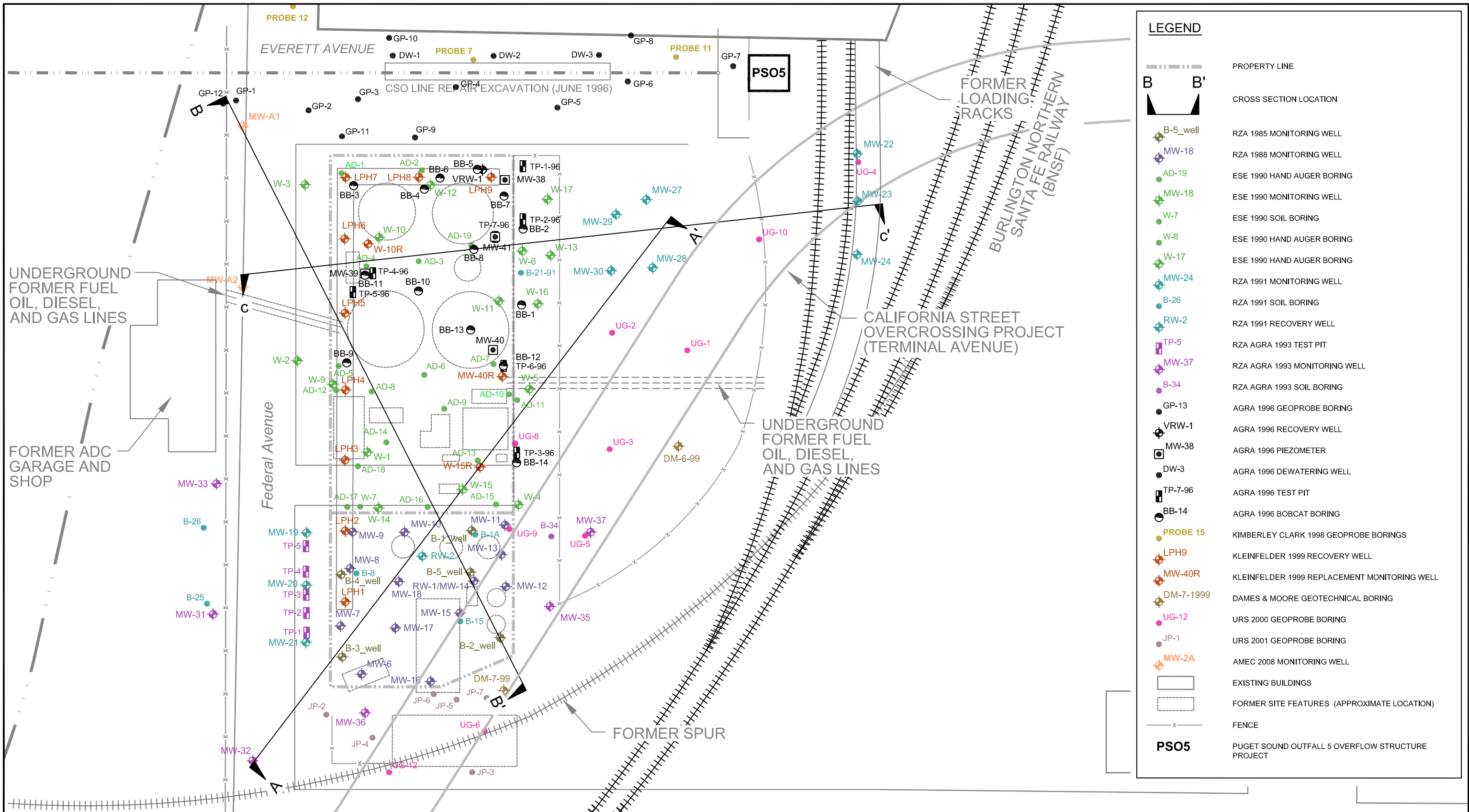

LEGEND	
	PROPERTY LINE
	CROSS SECTION LOCATION
	RZA 1985 MONITORING WELL
	RZA 1988 MONITORING WELL
	ESE 1990 HAND AUGER BORING
	ESE 1990 MONITORING WELL
	ESE 1990 SOIL BORING
	ESE 1990 HAND AUGER BORING
	ESE 1990 HAND AUGER BORING
	ESE 1990 HAND AUGER BORING
	RZA 1991 MONITORING WELL
	RZA 1991 SOIL BORING
	RZA 1991 RECOVERY WELL
	RZA AGRA 1993 TEST PIT
	RZA AGRA 1993 MONITORING WELL
	RZA AGRA 1993 SOIL BORING
	AGRA 1996 GEOPROBE BORING
	AGRA 1996 RECOVERY WELL
	AGRA 1996 PIEZOMETER
	AGRA 1996 DEWATERING WELL
	AGRA 1996 TEST PIT
	AGRA 1996 BOBCAT BORING
	KIMBERLEY CLARK 1998 GEOPROBE BORINGS
	KLEINFELDER 1999 RECOVERY WELL
	KLEINFELDER 1999 REPLACEMENT MONITORING WELL
	DAMES & MOORE GEOTECHNICAL BORING
	URS 2000 GEOPROBE BORING
	URS 2001 GEOPROBE BORING
	AMEC 2008 MONITORING WELL
	EXISTING BUILDINGS
	FORMER SITE FEATURES (APPROXIMATE LOCATION)
	FENCE
	PSO5 PUGET SOUND OUTFALL 5 OVERFLOW STRUCTURE PROJECT

SOURCE: Modified from a map provided by City of Everett, ExxonMobil Oil Corporation and Environmental Resolution, Inc.

CLIENT LOGO

CLIENT:

**EXXONMOBIL AND AMERICAN DISTRIBUTING COMPANY**

AMEC Earth & Environmental  
11810 North Creek Parkway North  
Bothell, WA, U.S.A. 98011-8201

DWN BY: JRS / BRJ  
CHK'D BY: AS/MS  
DATUM: NONE  
PROJECTION: NONE  
SCALE: 1" = 60'

PROJECT  
**EXXONMOBIL/ADC PROPERTY**  
ECOLOGY SITE ID 2728

TITLE  
**HISTORICAL EXPLORATIONS AND LOCATIONS OF GEOLOGIC CROSS SECTIONS A-A', B-B', AND C-C'**

DATE: AUGUST 2009  
PROJECT NO: 9-915-15716-C  
REV. NO.: 1  
FIGURE No. 15

0 60 120  
SCALE IN FEET

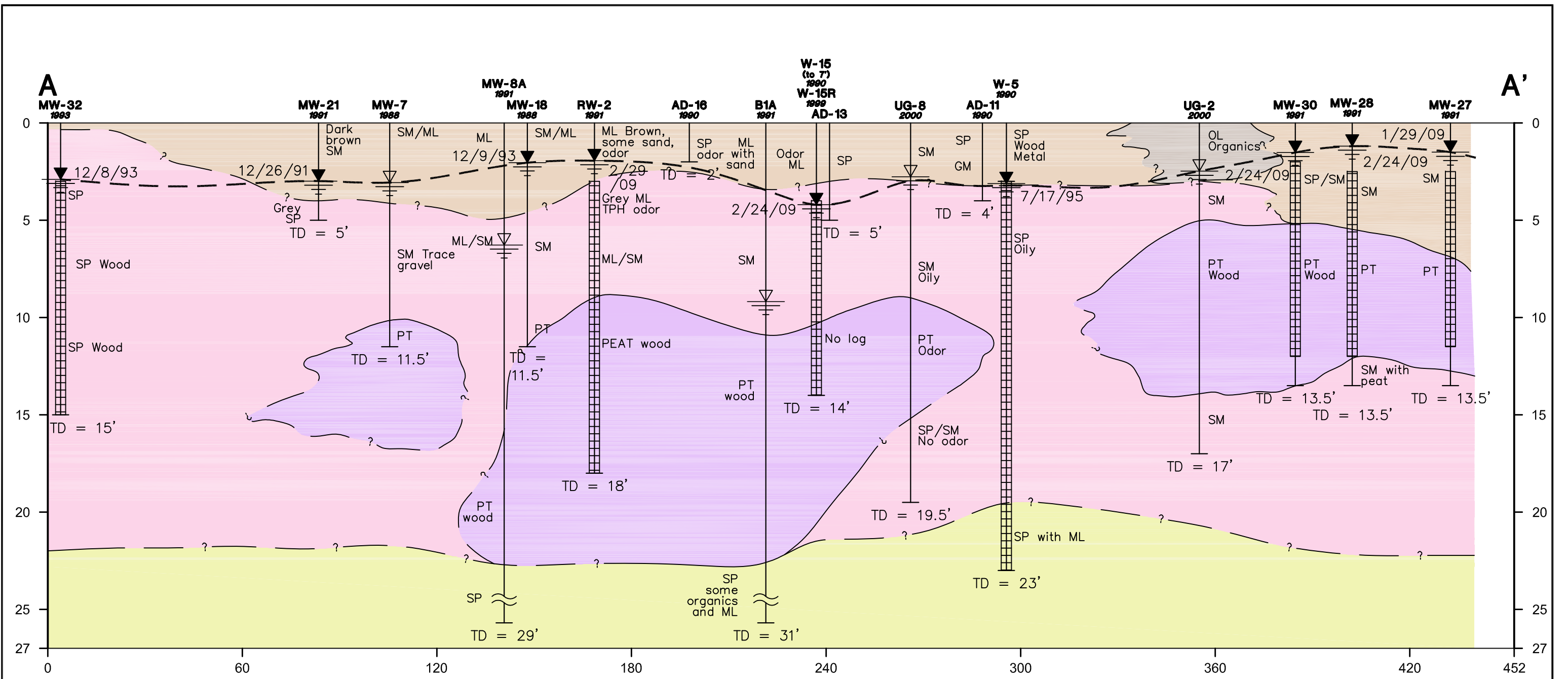

**LEGEND**

<b>FILL</b>	<b>MARSHLAND MATERIALS</b>	<b>TRANSITIONAL BEDS</b>	12/26/91	Static water level measured after drilling and date measured	<b>AD-16</b> 1990	Boring number and year installed	<b>MW-30</b> 1991	Well number and year installed
SM/SP Brown silty SAND and SAND	SM/SP Grey silty SAND and SAND	ML SILT with organics	Water level during drilling					
OL Organic SILT	PT PEAT with wood	SP Dense coarse SAND	Unconfined groundwater table					
	ML SILT							
	GP/GM Silty GRAVEL/GRAVEL							

TD = 2' Total depth in feet      TD = 15' Total depth in feet

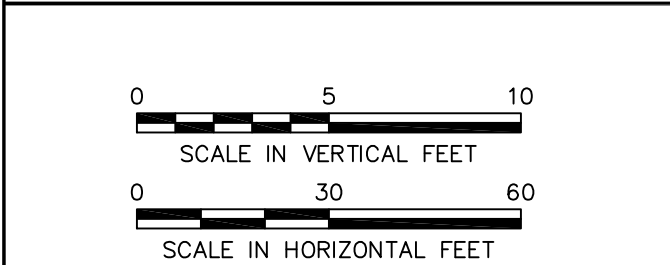

CLIENT LOGO

CLIENT:  
**EXXONMOBIL AND AMERICAN DISTRIBUTING COMPANY**

**AMEC Earth & Environmental**  
11810 North Creek Parkway North  
Bothell, WA, U.S.A. 98011-8201

DWN BY: JRS  
CHK'D BY: AS  
DATUM: NONE  
PROJECTION: NONE  
SCALE: AS SHOWN

PROJECT  
**EXXONMOBIL/ADC PROPERTY**  
ECOLOGY SITE ID 2728

TITLE  
**GEOLOGIC CROSS SECTION A-A'**

DATE:  
AUGUST 2009

PROJECT NO:  
9-915-15716-C

REV. NO.:

FIGURE No.  
16

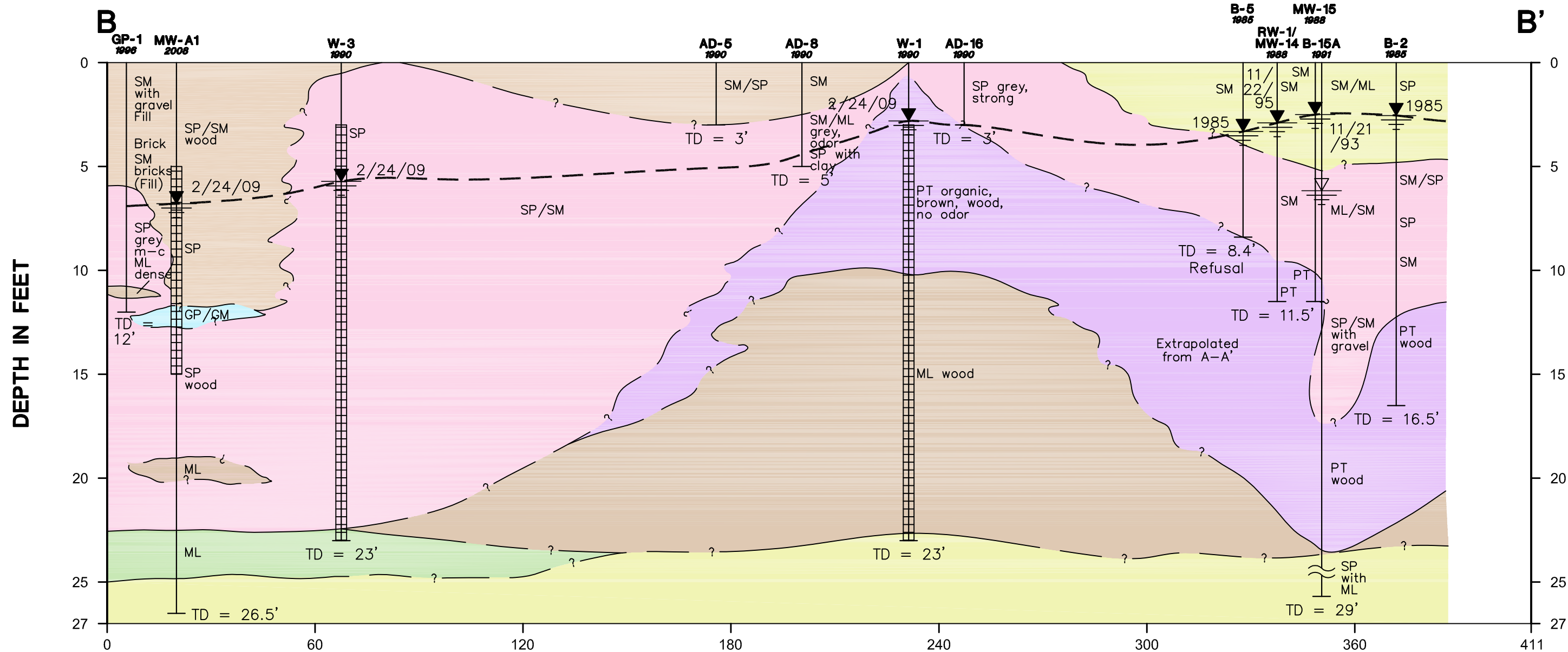

**LEGEND**

<b>FILL</b>	<b>MARSHLAND MATERIALS</b>	<b>TRANSITIONAL BEDS</b>	12/26/91	Static water level measured after drilling and date measured	<b>AD-8 1990</b>	Boring number and year installed	<b>MW-A1 2008</b>	Well number and year installed
SM/SP Brown silty SAND and SAND	SM/SP Grey silty SAND and SAND	ML SILT with organics		Water level during drilling				
OL Organic SILT	PT PEAT with wood	SP Dense coarse SAND		Unconfined groundwater table		TD = 5' Total depth in feet		TD = 23' Total depth in feet
	ML SILT							
	GP/GM Silty GRAVEL/GRAVEL							

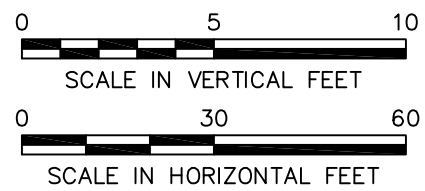

CLIENT LOGO

CLIENT:

**EXXONMOBIL AND AMERICAN DISTRIBUTING COMPANY**

**AMEC Earth & Environmental**  
11810 North Creek Parkway North  
Bothell, WA, U.S.A. 98011-8201

DWN BY: JRS  
CHK'D BY: AS  
DATUM: NONE  
PROJECTION: NONE  
SCALE: AS SHOWN

PROJECT

**EXXONMOBIL/ADC PROPERTY**  
ECOLOGY SITE ID 2728

TITLE

**GEOLOGIC CROSS SECTION B-B'**

DATE: AUGUST 2009  
PROJECT NO: 9-915-15716-C  
REV. NO.:  
FIGURE No. 17



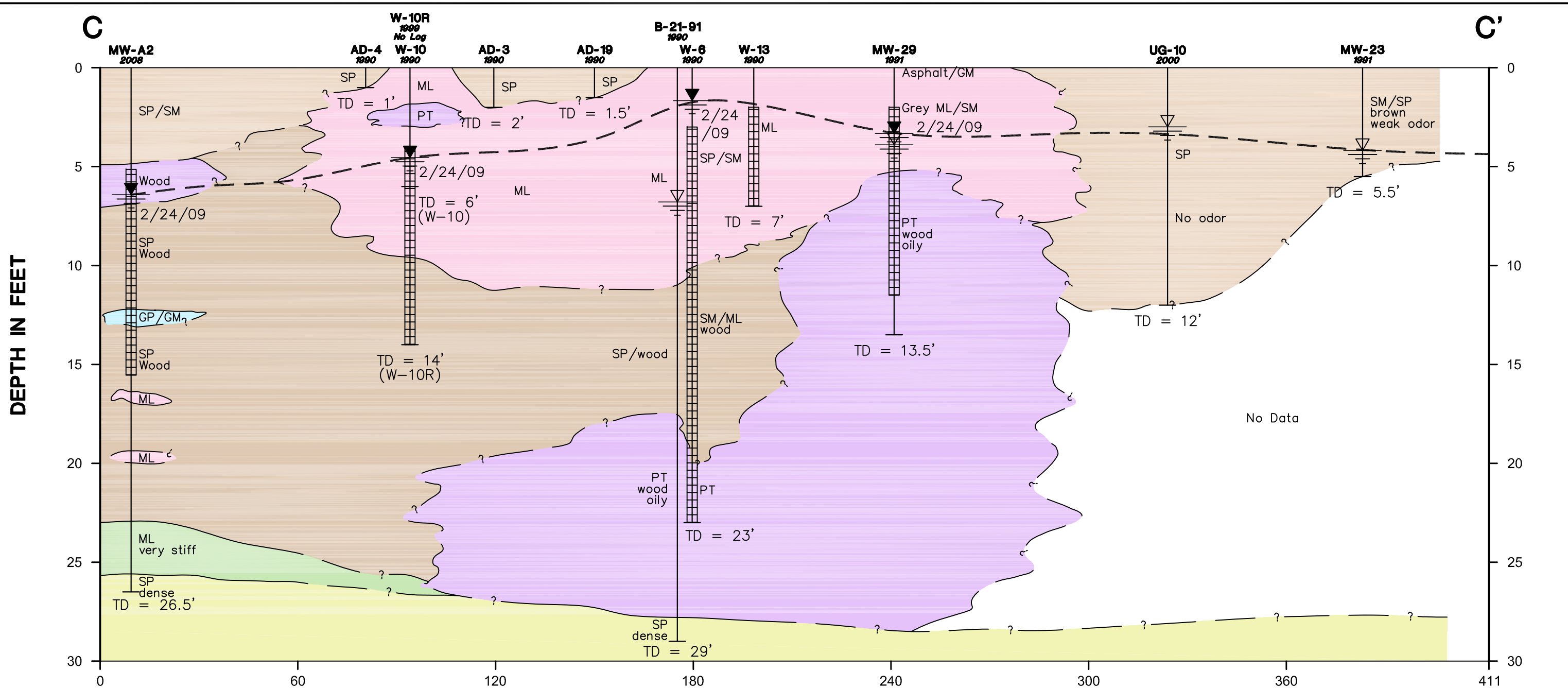

**LEGEND**

<b>FILL</b>	<b>MARSHLAND MATERIALS</b>	<b>TRANSITIONAL BEDS</b>	12/26/91	Static water level measured after drilling and date measured	<b>AD-4 1990</b>	Boring number and year installed	<b>MW-A2 2008</b>	Well number and year installed
SM/SP Brown silty SAND and SAND	SM/SP Grey silty SAND and SAND	ML SILT with organics		Water level during drilling				
OL Organic SILT	PT PEAT with wood	SP Dense coarse SAND		Unconfined groundwater table				
	ML SILT							
	GP/GM Silty GRAVEL/GRAVEL							

TD = 1' Total depth in feet      TD = 26' Total depth in feet

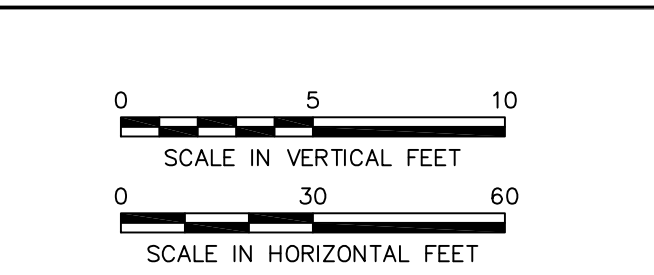

CLIENT LOGO

CLIENT:  
**EXXONMOBIL AND AMERICAN DISTRIBUTING COMPANY**  
 AMEC Earth & Environmental  
 11810 North Creek Parkway North  
 Bothell, WA, U.S.A. 98011-8201

DWN BY: JRS  
 CHK'D BY: AS  
 DATUM: NONE  
 PROJECTION: NONE  
 SCALE: AS SHOWN

PROJECT  
**EXXONMOBIL/ADC PROPERTY**  
 ECOLOGY SITE ID 2728  
 TITLE  
**GEOLOGIC CROSS SECTION C-C'**

DATE: AUGUST 2009  
 PROJECT NO: 9-915-15716-C  
 REV. NO.:  
 FIGURE No. **18**

MW22 MW23 MW24

SOURCE: Modified from a map provided by City of Everett, ExxonMobil Oil Corporation and Environmental Resolution, Inc.

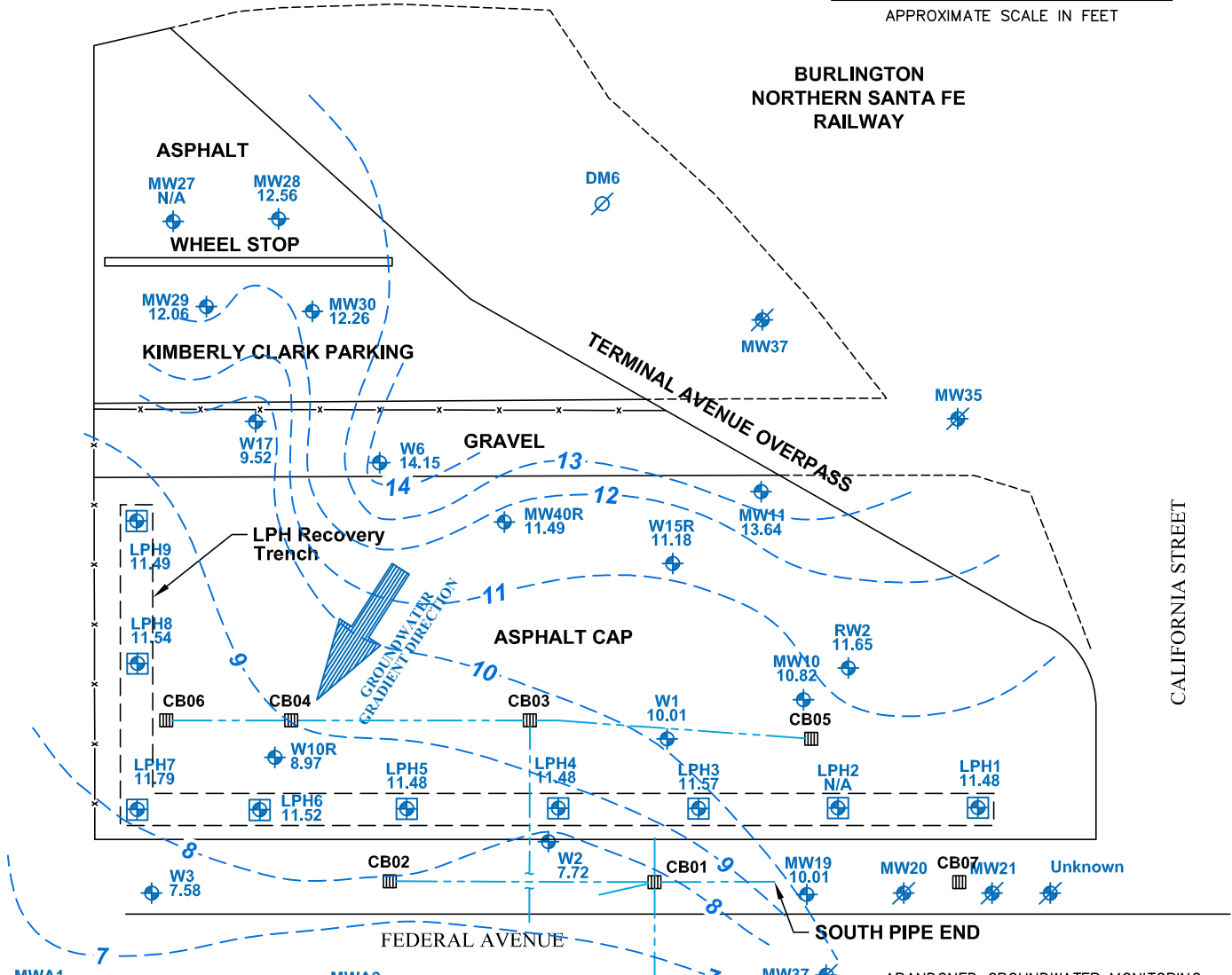
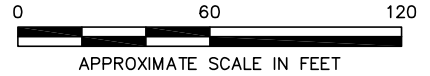

- EXPLANATION**
- MW2 GROUNDWATER MONITORING WELL
  - 12.56 GROUNDWATER ELEVATION (FEET ABOVE MEAN SEA LEVEL, FEBRUARY 24, 2009)
  - NM NOT MEASURED
  - NE NOT ESTABLISHED
  - - - - - INFERRED GROUNDWATER ELEVATION CONTOUR LINE (FEET ABOVE MEAN SEA LEVEL)
  - INFERRED GROUNDWATER FLOW DIRECTION

- ABANDONED GROUNDWATER MONITORING WELL
- LPH RECOVERY WELL
- ABANDONED PIEZOMETER
- FORMERLY MW18
- NOT AVAILABLE
- x - FENCE
- CATCH BASIN
- STORM DRAIN LINE

NOTE: Groundwater elevations in LPH wells were not used in contouring.

**AMEC Earth & Environmental**  
 11810 North Creek Parkway North  
 Bothell, WA, U.S.A. 98011-8201



CLIENT LOGO CLIENT  
**EXXONMOBIL AND AMERICAN DISTRIBUTING COMPANY**

PROJECT	EXXONMOBIL/ADC PROPERTY, ECOLOGY SITE ID 2728	DWN BY:	JRS	DATUM:	NONE	DATE:	AUGUST 2009
TITLE	GROUNDWATER ELEVATION AND FLOW DIRECTION ON FEBRUARY 24, 2009	CHK'D BY:	AS/MS	REV. NO.:		PROJECT NO.:	9-915-15716-C
		PROJECTION:	NONE	SCALE:	AS SHOWN	FIGURE No.	19

G:\91\15000\15716-C - Exxon Mobil\15716-C-19.dwg - Layout1 - Aug. 17, 2009 10:20am - jeffrey.sanders

MW22 MW23 MW24

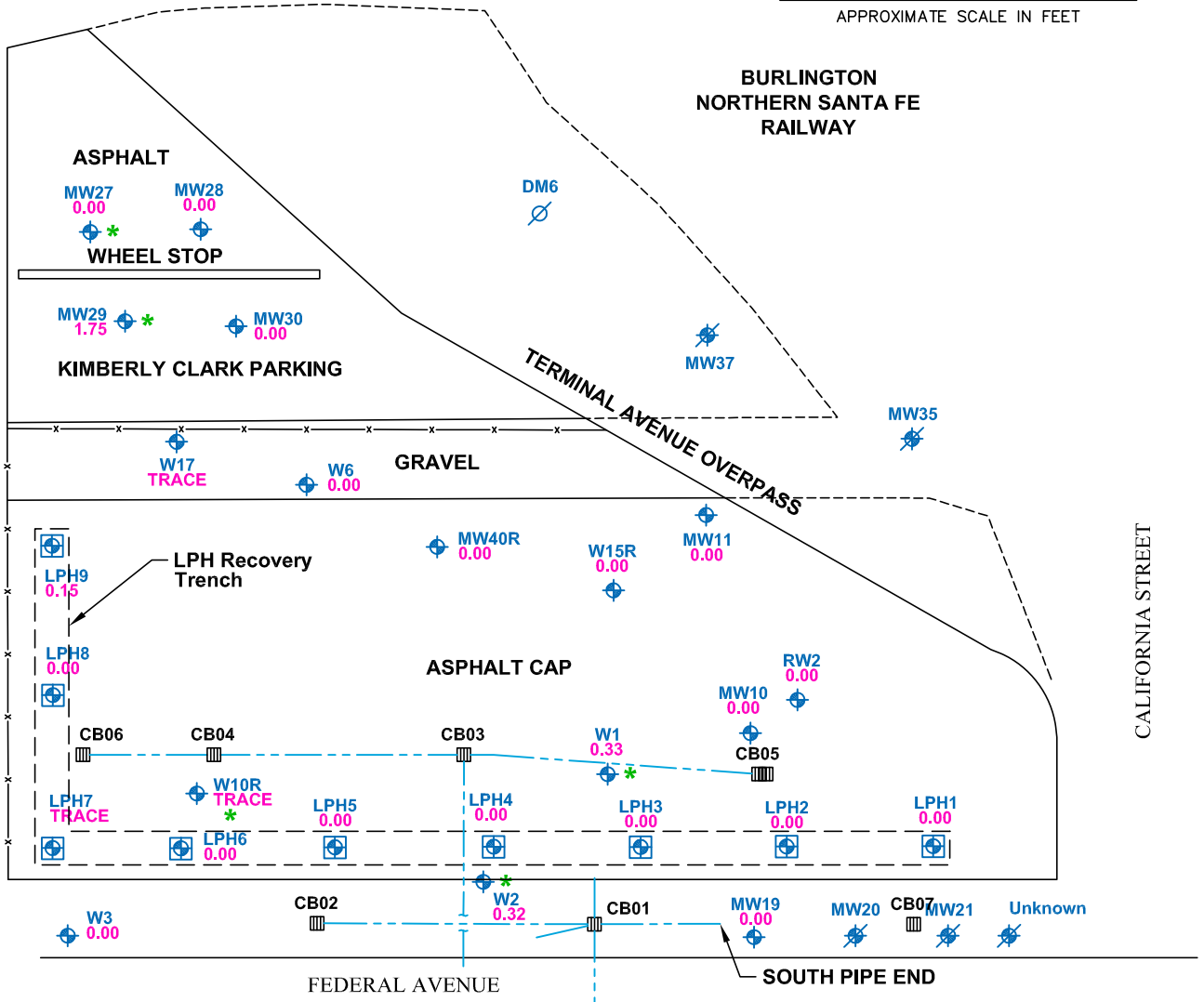
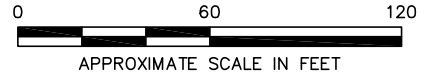

MWA1  
0.00

MWA2  
0.00

**EXPLANATION**

- MW2 GROUNDWATER MONITORING WELL
- 1.75 AVERAGE LIQUID-PHASE PETROLEUM HYDROCARBON (LPH) THICKNESS IN FEET\*
- \* OLEOPHILIC SOCK
- MW37 ABANDONED GROUNDWATER MONITORING WELL
- LPH9 LPH RECOVERY WELL

- DM6 ABANDONED PIEZOMETER
- RW2 FORMERLY MW18
- x- FENCE
- CATCH BASIN
- - - STORM DRAIN LINE

\* Values averaged from data collected September 2008 to February 2009.

SOURCE: Modified from a map provided by City of Everett, ExxonMobil Oil Corporation and Environmental Resolution, Inc.

**AMEC Earth & Environmental**

11810 North Creek Parkway North  
Bothell, WA, U.S.A. 98011-8201



CLIENT LOGO

CLIENT

**EXXONMOBIL AND  
AMERICAN DISTRIBUTING COMPANY**

PROJECT **EXXONMOBIL/ADC PROPERTY, ECOLOGY SITE ID 2728**

DWN BY: JRS      DATUM: NONE      DATE: JUNE 2009

TITLE **AVERAGE LPH THICKNESS  
FROM SEPTEMBER 2008 TO FEBRUARY 2009**

CHK'D BY: AS/MS      REV. NO.:      PROJECT NO: 9-915-15716-C

PROJECTION: NONE      SCALE: AS SHOWN      FIGURE No. 20

SOURCE: Modified from a map provided by City of Everett, ExxonMobil Oil Corporation and Environmental Resolution, Inc.

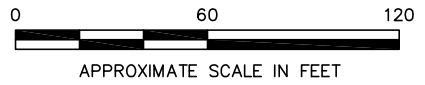

8/28/08	2/12/09	8/28/08	2/12/09	8/28/08	2/12/09
134	145	314	239	ND	280
2,850	2,080	2,100	1,400	27,900	444
2,600	414	1,840	364	23,800	323
ND	ND	ND	ND	ND	ND
ND	ND	ND	ND	ND	ND
ND	ND	ND	ND	ND	ND
ND	ND	ND	ND	ND	ND

**BURLINGTON  
NORTHERN SANTA FE  
RAILWAY**

8/28/08	2/12/09
1,070	855
10,600	3,110
8,990	959
4.91	3.65
1.2	3.39
2.29	1.25
5.97	6.4

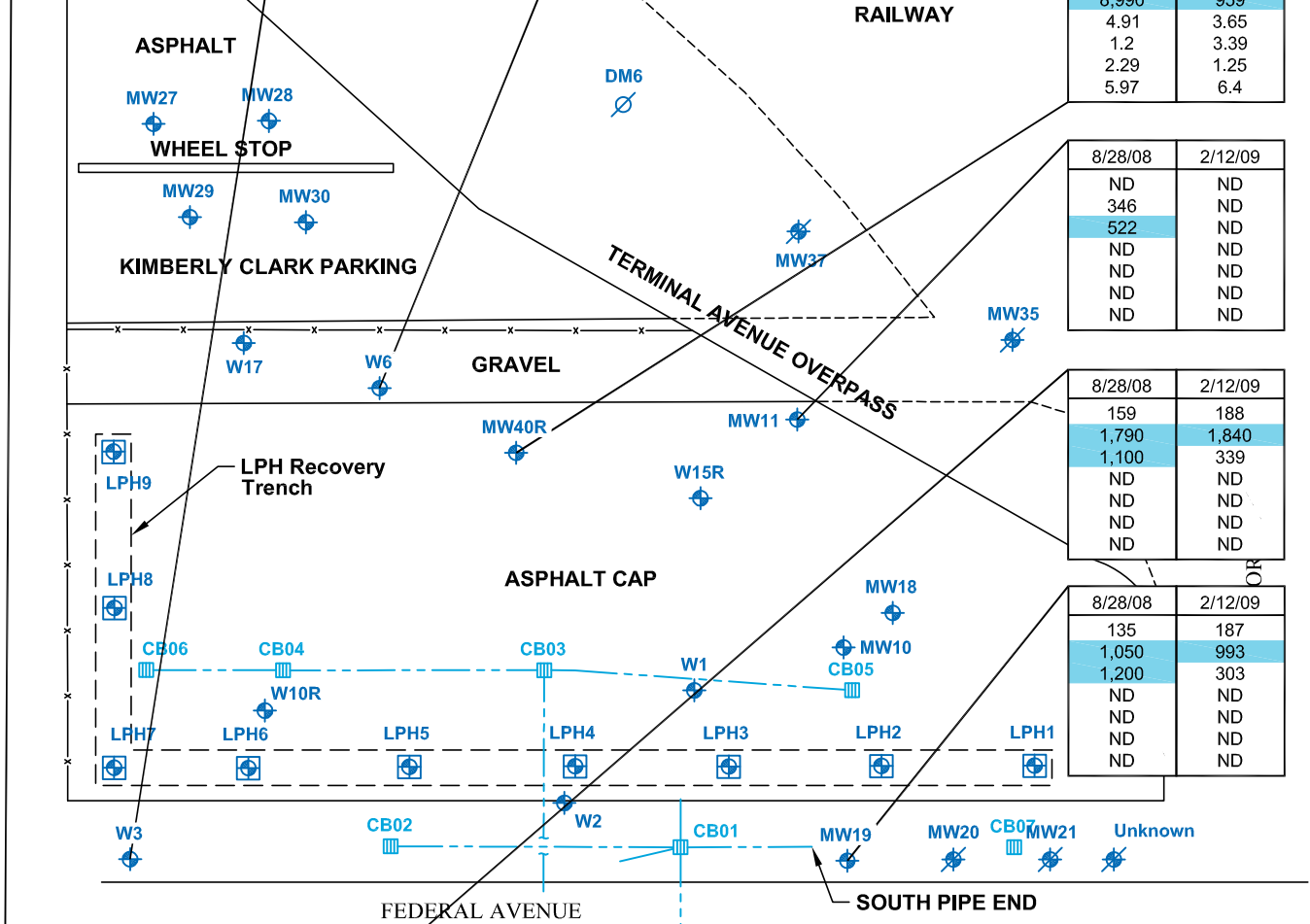

8/28/08	2/12/09
ND	ND
346	ND
522	ND
ND	ND
ND	ND
ND	ND
ND	ND

8/28/08	2/12/09
159	188
1,790	1,840
1,100	339
ND	ND
ND	ND
ND	ND
ND	ND

8/28/08	2/12/09
135	187
1,050	993
1,200	303
ND	ND
ND	ND
ND	ND
ND	ND

**EXPLANATION**

- MW2 GROUNDWATER MONITORING WELL
- MW37 ABANDONED GROUNDWATER MONITORING WELL
- LPH9 LPH RECOVERY WELL
- DM6 ABANDONED PIEZOMETER
- x- FENCE
- CATCH BASIN
- - - STORM DRAIN LINE

2/12/09	SAMPLE DATE
855	TOTAL PETROLEUM HYDROCARBONS AS GASOLINE
3,110	TOTAL PETROLEUM HYDROCARBONS AS DIESEL
959	TOTAL PETROLEUM HYDROCARBONS AS OIL
3.65	BENZENE
3.39	TOLUENE
1.25	ETHYLBENZENE
6.4	TOTAL XYLENES
	ABOVE MTCA A CLEANUP LEVEL
ND	NOT DETECTED

**AMEC Earth & Environmental**  
11810 North Creek Parkway North  
Bothell, WA, U.S.A. 98011-8201



CLIENT LOGO CLIENT  
**EXXONMOBIL AND  
AMERICAN DISTRIBUTING COMPANY**

PROJECT EXXONMOBIL/ADC PROPERTY, ECOLOGY SITE ID 2728

DWN BY: JRS DATUM: NONE DATE: AUGUST 2009

TITLE **GROUNDWATER SAMPLE  
ANALYTICAL RESULTS  
AUGUST 2008 & FEBRUARY 2009**

CHK'D BY: AS/MS REV. NO.: PROJECT NO: 9-915-15716-C  
PROJECTION: NONE SCALE: AS SHOWN FIGURE No. 21

G:\91\15000\15716-C - Exxon Mobil\15716-C-16.dwg - Layout1 - Aug. 17, 2009 11:14am - jeffrey.sanders

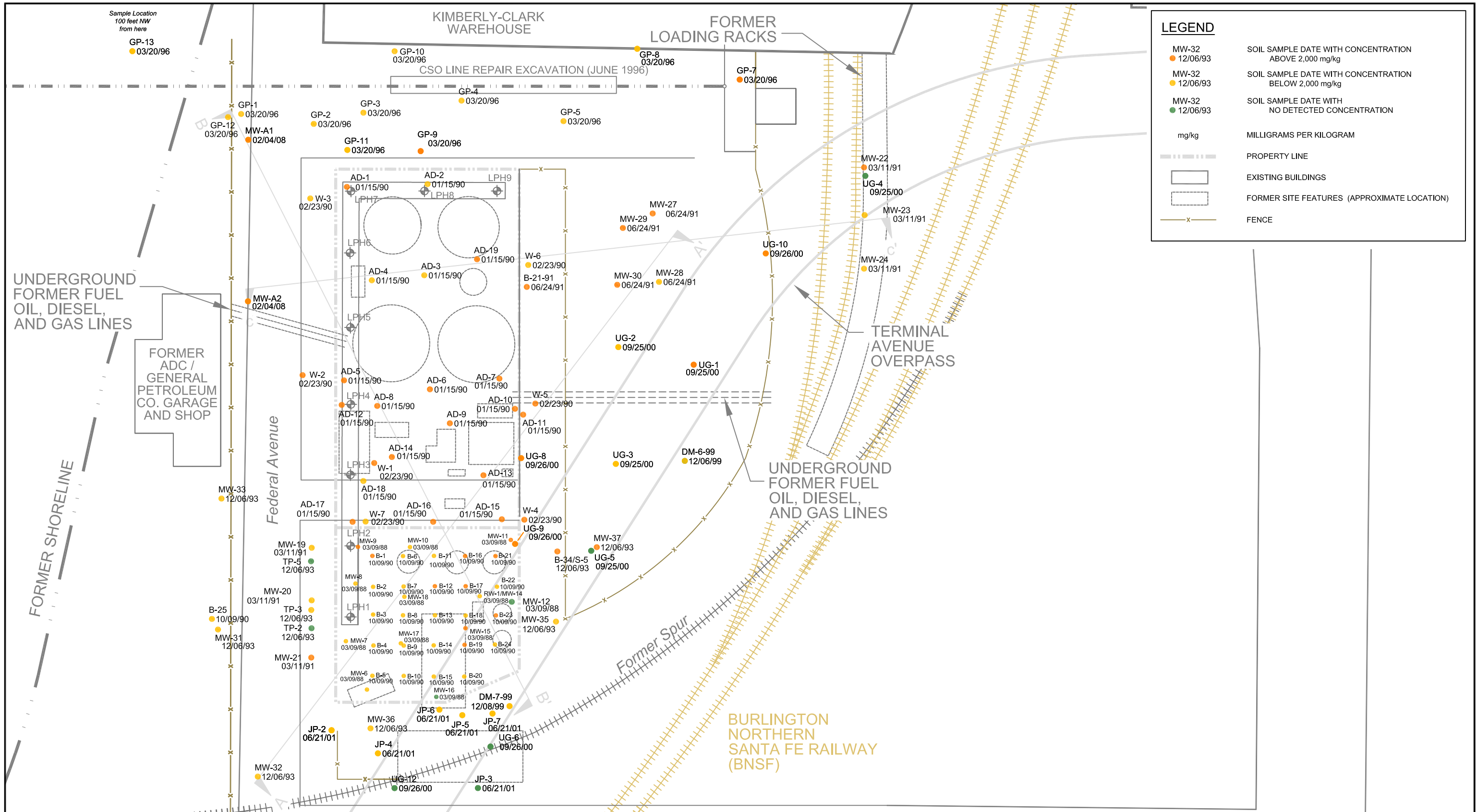

SOURCE: Modified from a map provided by City of Everett, ExxonMobil Oil Corporation and Environmental Resolution, Inc.

SCALE IN FEET

CLIENT LOGO

CLIENT:

**EXXONMOBIL AND AMERICAN DISTRIBUTING COMPANY**

**AMEC Earth & Environmental**  
 11810 North Creek Parkway North  
 Bothell, WA, U.S.A. 98011-8201

DWN BY: JRS / BRJ  
 CHK'D BY: AIS  
 DATUM: NONE  
 PROJECTION: NONE  
 SCALE: 1" = 60'

PROJECT

**EXXONMOBIL/ADC PROPERTY**  
**ECOLOGY SITE ID 2728**

TITLE

**HORIZONTAL DISTRIBUTION**  
**OF TPH-DIESEL, TPH-OIL,**  
**AND UNDIFFERENTIATED TPH IN SOIL**

DATE: AUGUST 2009  
 PROJECT NO: 9-915-15716-C  
 REV. NO.: 1  
 FIGURE No. 22

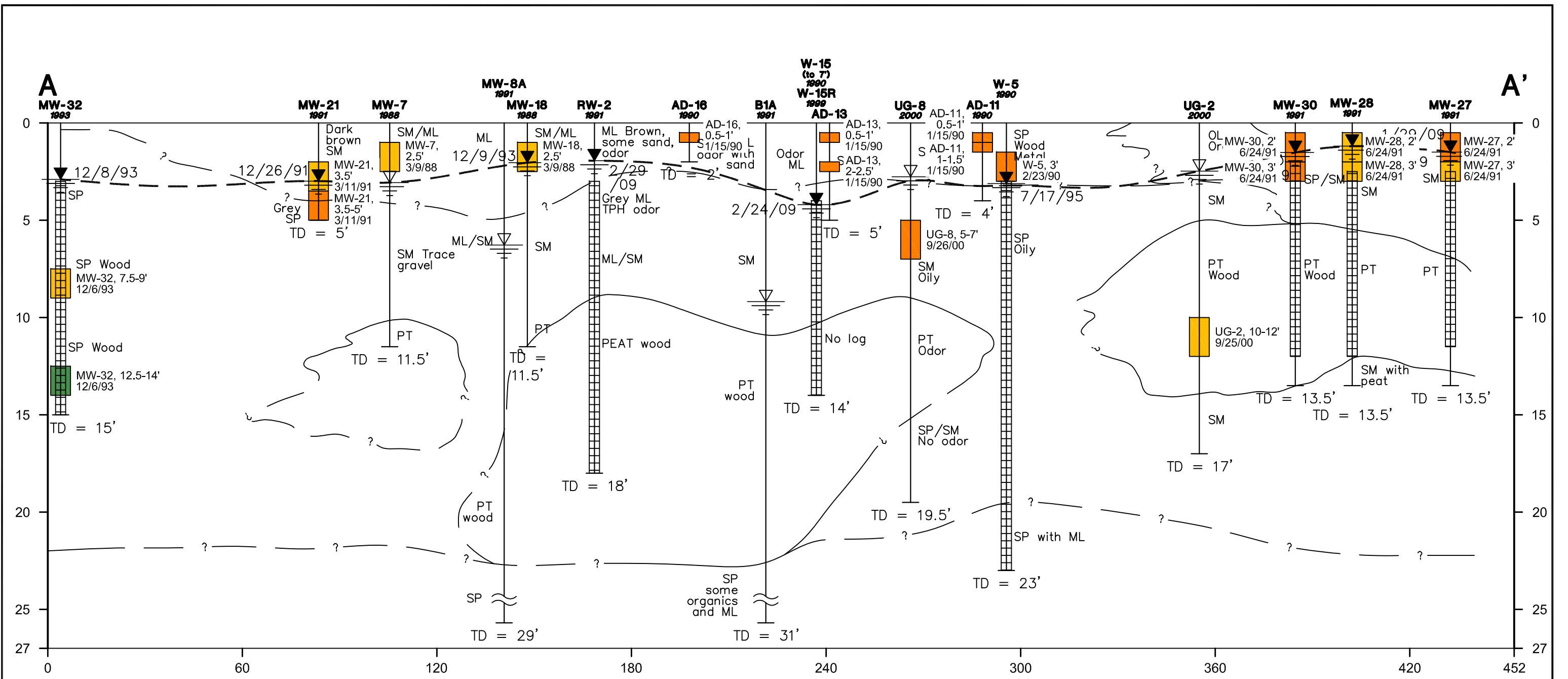

**LEGEND**

12/26/91 Static water level measured after drilling and date measured

Water level during drilling

Unconfined groundwater table

AD-16 Boring number and year installed

MW-30 Well number and year installed

TD = 2' Total depth in feet

TD = 15' Total depth in feet

**TPH-D or TPH (Undifferentiated)**

Detected ≥ 2,000 mg/kg

Detected < 2,000 mg/kg

Not detected

mg/kg Milligram per kilogram

UG-2, 10-12' 9/25/00 Sample depth and date collected

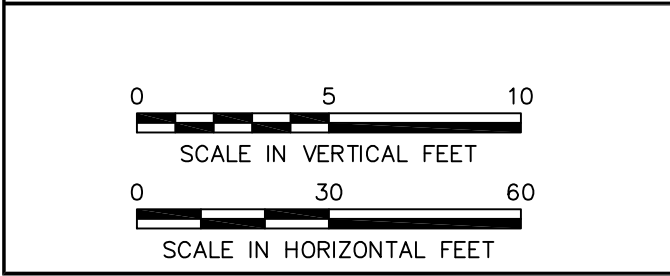

CLIENT LOGO

CLIENT:

**EXXONMOBIL AND AMERICAN DISTRIBUTING COMPANY**

AMEC Earth & Environmental  
11810 North Creek Parkway North  
Bothell, WA, U.S.A. 98011-8201

DWN BY: JRS

CHK'D BY: AS

DATUM: NONE

PROJECTION: NONE

SCALE: AS SHOWN

PROJECT

EXXONMOBIL/ADC PROPERTY  
ECOLOGY SITE ID 2728

TITLE

**VERTICAL DISTRIBUTION OF TPH-D OR TPH (UNDIFFERENTIATED) IN SOIL: CROSS SECTION A-A'**

DATE: AUGUST 2009

PROJECT NO: 9-915-15716-C

REV. NO.:

FIGURE No. 23

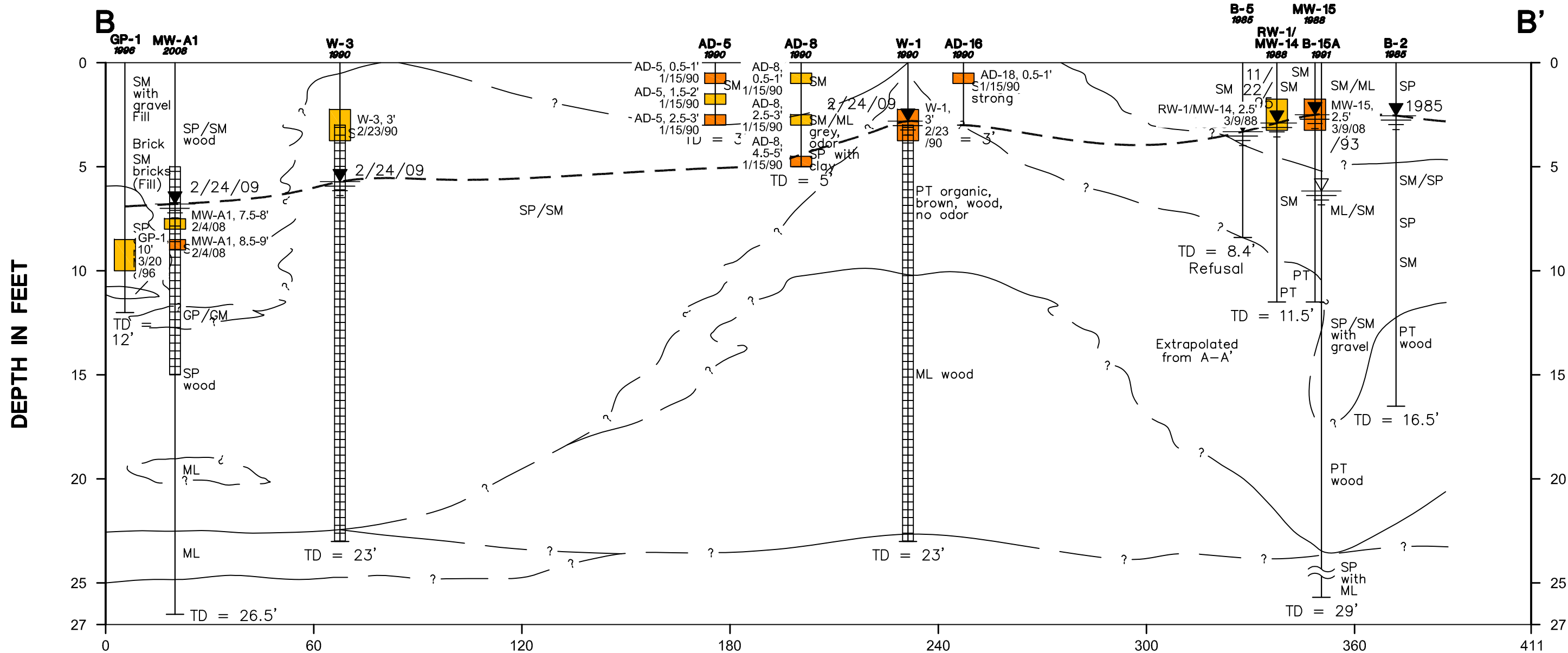

**LEGEND**

12/26/91  
 Static water level measured after drilling and date measured

Water level during drilling

Unconfined groundwater table

**AD-5 1990** Boring number and year installed  
 TD = 3' Total depth in feet

**MW-A1 2008** Well number and year installed  
 TD = 23' Total depth in feet

**TPH-D or TPH (Undifferentiated)**

Detected ≥ 2,000 mg/kg

Detected < 2,000 mg/kg

Not detected

mg/kg Milligram per kilogram

Sample depth and date collected

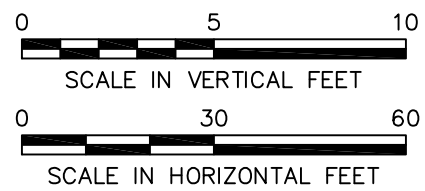

CLIENT LOGO

CLIENT:

**EXXONMOBIL AND AMERICAN DISTRIBUTING COMPANY**

AMEC Earth & Environmental  
 11810 North Creek Parkway North  
 Bothell, WA, U.S.A. 98011-8201

DWN BY: JRS  
 CHK'D BY: AS  
 DATUM: NONE  
 PROJECTION: NONE  
 SCALE: AS SHOWN

PROJECT: EXXONMOBIL/ADC PROPERTY  
 ECOLOGY SITE ID 2728

TITLE: VERTICAL DISTRIBUTION OF TPH-D OR TPH (UNDIFFERENTIATED) IN SOIL: CROSS SECTION B-B'

DATE: AUGUST 2009  
 PROJECT NO: 9-915-15716-C  
 REV. NO.:  
 FIGURE No. 24

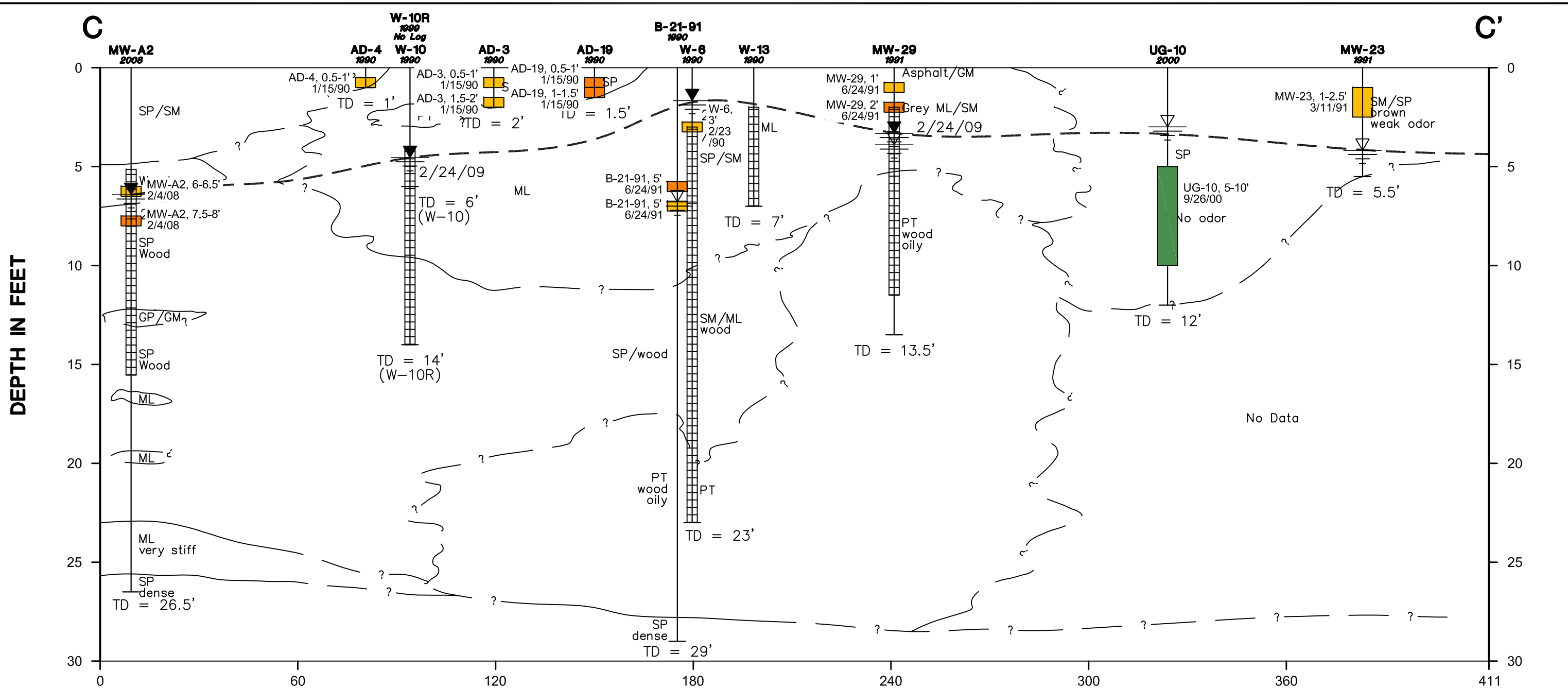

**LEGEND**

12/26/91 Static water level measured after drilling and date measured

Water level during drilling

Unconfined groundwater table

**AD-4 1990** Boring number and year installed

**TD = 1'** Total depth in feet

**MW-A2 2008** Well number and year installed

Screen interval

**TD = 26'** Total depth in feet

**TPH-D or TPH (Undifferentiated)**

Detected  $\geq 2,000$  mg/kg

Detected  $< 2,000$  mg/kg

Not detected

mg/kg Milligram per kilogram

UG-10, 5-10' 9/26/00 Sample depth and date collected

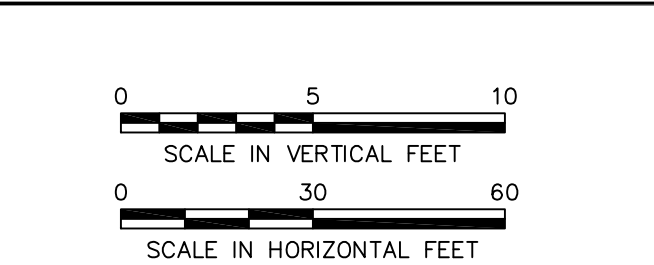

CLIENT LOGO

CLIENT:

**EXXONMOBIL AND AMERICAN DISTRIBUTING COMPANY**

**AMEC Earth & Environmental**  
11810 North Creek Parkway North  
Bothell, WA, U.S.A. 98011-8201

DWN BY: JRS  
CHK'D BY: AS  
DATUM: NONE  
PROJECTION: NONE  
SCALE: AS SHOWN

PROJECT: EXXONMOBIL/ADC PROPERTY  
ECOLOGY SITE ID 2728

TITLE: VERTICAL DISTRIBUTION OF TPH-D OR TPH (UNDIFFERENTIATED) IN SOIL: CROSS SECTION C-C'

DATE: AUGUST 2009  
PROJECT NO.: 9-915-15716-C  
REV. NO.:  
FIGURE No. 25



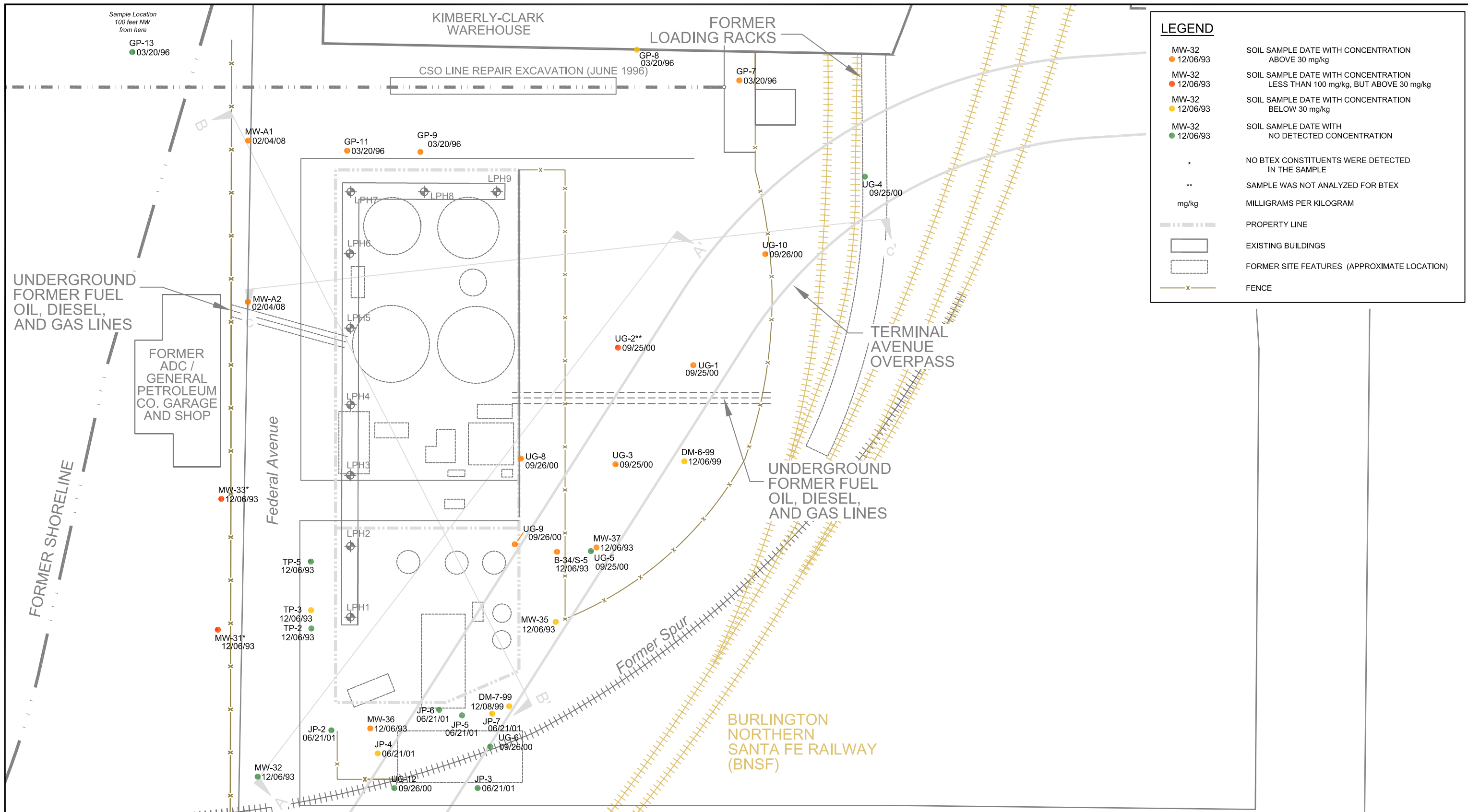

LEGEND	
MW-32 ● 12/06/93	SOIL SAMPLE DATE WITH CONCENTRATION ABOVE 30 mg/kg
MW-32 ● 12/06/93	SOIL SAMPLE DATE WITH CONCENTRATION LESS THAN 100 mg/kg, BUT ABOVE 30 mg/kg
MW-32 ● 12/06/93	SOIL SAMPLE DATE WITH CONCENTRATION BELOW 30 mg/kg
MW-32 ● 12/06/93	SOIL SAMPLE DATE WITH NO DETECTED CONCENTRATION
.	NO BTEX CONSTITUENTS WERE DETECTED IN THE SAMPLE
**	SAMPLE WAS NOT ANALYZED FOR BTEX
mg/kg	MILLIGRAMS PER KILOGRAM
---	PROPERTY LINE
[Solid Line]	EXISTING BUILDINGS
[Dashed Line]	FORMER SITE FEATURES (APPROXIMATE LOCATION)
-x-	FENCE

SOURCE: Modified from a map provided by City of Everett, ExxonMobil Oil Corporation and Environmental Resolution, Inc.

SCALE IN FEET

CLIENT LOGO

CLIENT:

**EXXONMOBIL AND AMERICAN DISTRIBUTING COMPANY**

**AMEC Earth & Environmental**  
11810 North Creek Parkway North  
Bothell, WA, U.S.A. 98011-8201

DWN BY:	JRS / BRJ
CHK'D BY:	AIS
DATUM:	NONE
PROJECTION:	NONE
SCALE:	1" = 60'

PROJECT	<b>EXXONMOBIL/ADC PROPERTY ECOLOGY SITE ID 2728</b>
TITLE	<b>HORIZONTAL DISTRIBUTION OF TPH-GASOLINE IN SOIL</b>

DATE:	AUGUST 2009
PROJECT NO.:	9-915-15716-C
REV. NO.:	1
FIGURE No.	26

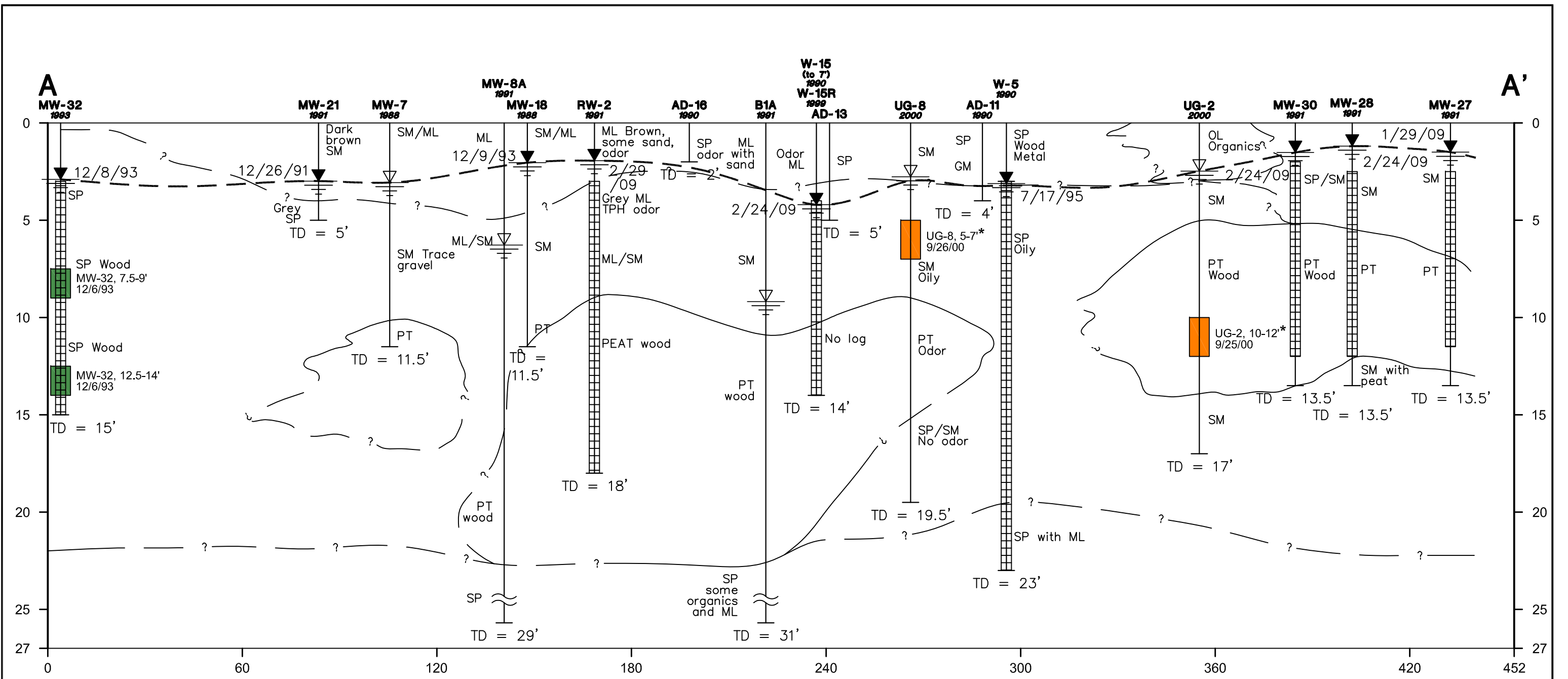

**LEGEND**

12/26/91 Static water level measured after drilling and date measured

Water level during drilling

Unconfined groundwater table

**AD-16 1990** Boring number and year installed

**MW-30 1991** Well number and year installed

Screen interval

**TPH-G**

- Detected ≥ 30 mg/kg
- Detected < 30 mg/kg
- Not detected

mg/kg Milligram per kilogram

UG-2, 10-12' 9/25/00 Sample depth and date collected

\* Sample was not analyzed for benzene

TD = 2' Total depth in feet

TD = 15' Total depth in feet

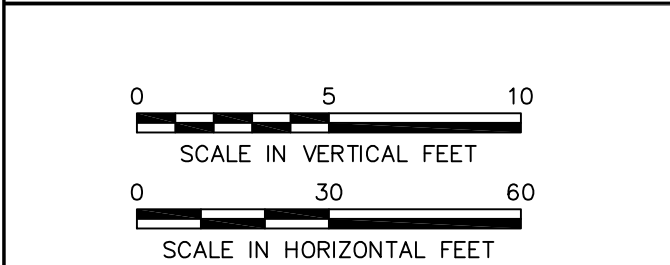

CLIENT LOGO

CLIENT:

**EXXONMOBIL AND AMERICAN DISTRIBUTING COMPANY**

**AMEC Earth & Environmental**

11810 North Creek Parkway North  
Bothell, WA, U.S.A. 98011-8201

DWN BY: JRS

CHK'D BY: AS

DATUM: NONE

PROJECTION: NONE

SCALE: AS SHOWN

PROJECT: EXXONMOBIL/ADC PROPERTY  
ECOLOGY SITE ID 2728

TITLE: VERTICAL DISTRIBUTION OF TPH-G IN SOIL CROSS SECTION A-A'

DATE: AUGUST 2009

PROJECT NO: 9-915-15716-C

REV. NO.:

FIGURE No. 27

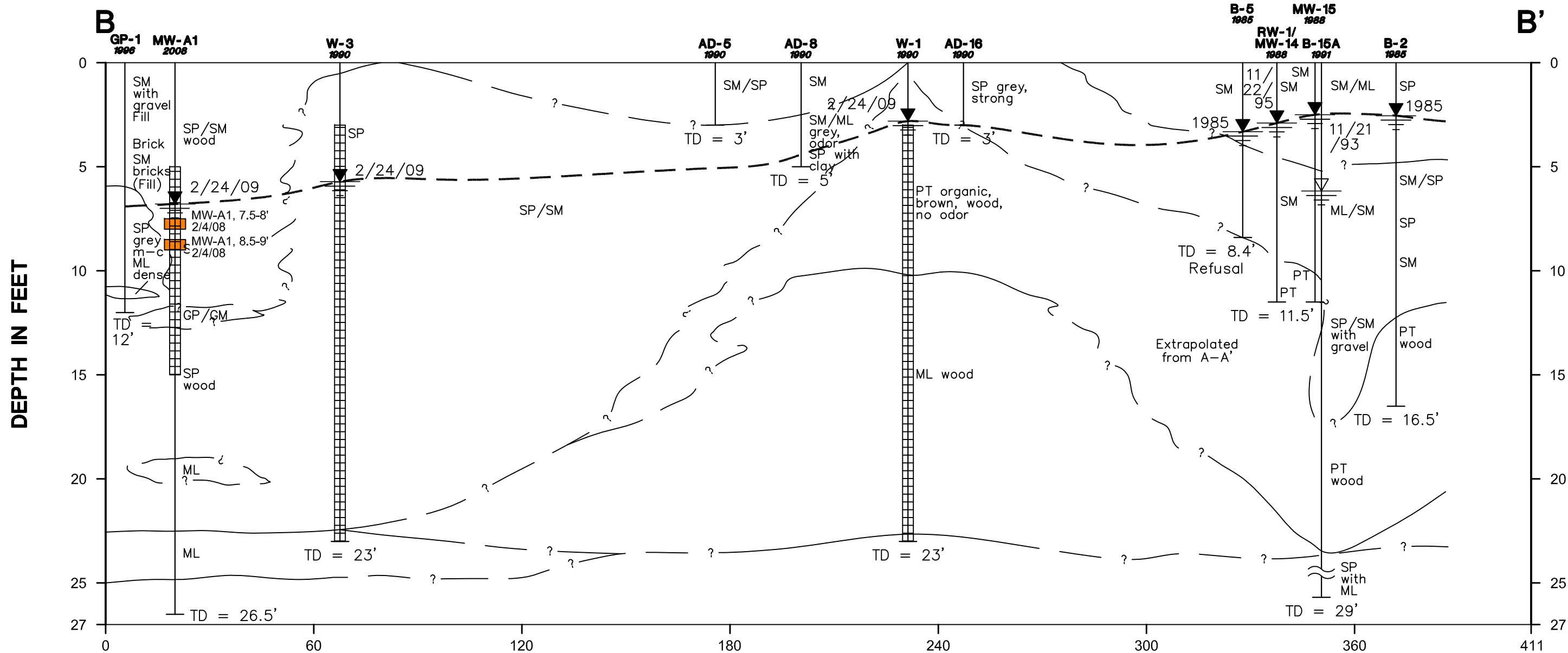

**LEGEND**

12/26/91 Static water level measured after drilling and date measured

Water level during drilling

Unconfined groundwater table

**AD-5 1990** Boring number and year installed

**MW-A1 2008** Well number and year installed

Screen interval

TD = 3' Total depth in feet

TD = 23' Total depth in feet

**TPH-G**

Detected ≥ 30 mg/kg

Detected < 30 mg/kg

Not detected

mg/kg Milligram per kilogram

UG-2, 10-12' 9/25/00 Sample depth and date collected

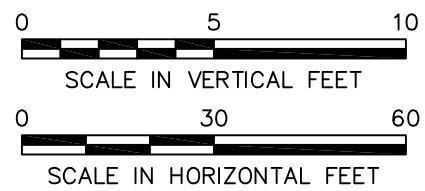

CLIENT LOGO

CLIENT:

**EXXONMOBIL AND AMERICAN DISTRIBUTING COMPANY**

**AMEC Earth & Environmental**  
 11810 North Creek Parkway North  
 Bothell, WA, U.S.A. 98011-8201

DWN BY: JRS

CHK'D BY: AS

DATUM: NONE

PROJECTION: NONE

SCALE: AS SHOWN

PROJECT

**EXXONMOBIL/ADC PROPERTY**  
**ECOLOGY SITE ID 2728**

TITLE

**VERTICAL DISTRIBUTION OF TPH-G IN SOIL CROSS SECTION B-B'**

DATE: AUGUST 2009

PROJECT NO: 9-915-15716-C

REV. NO.:

FIGURE No. **28**

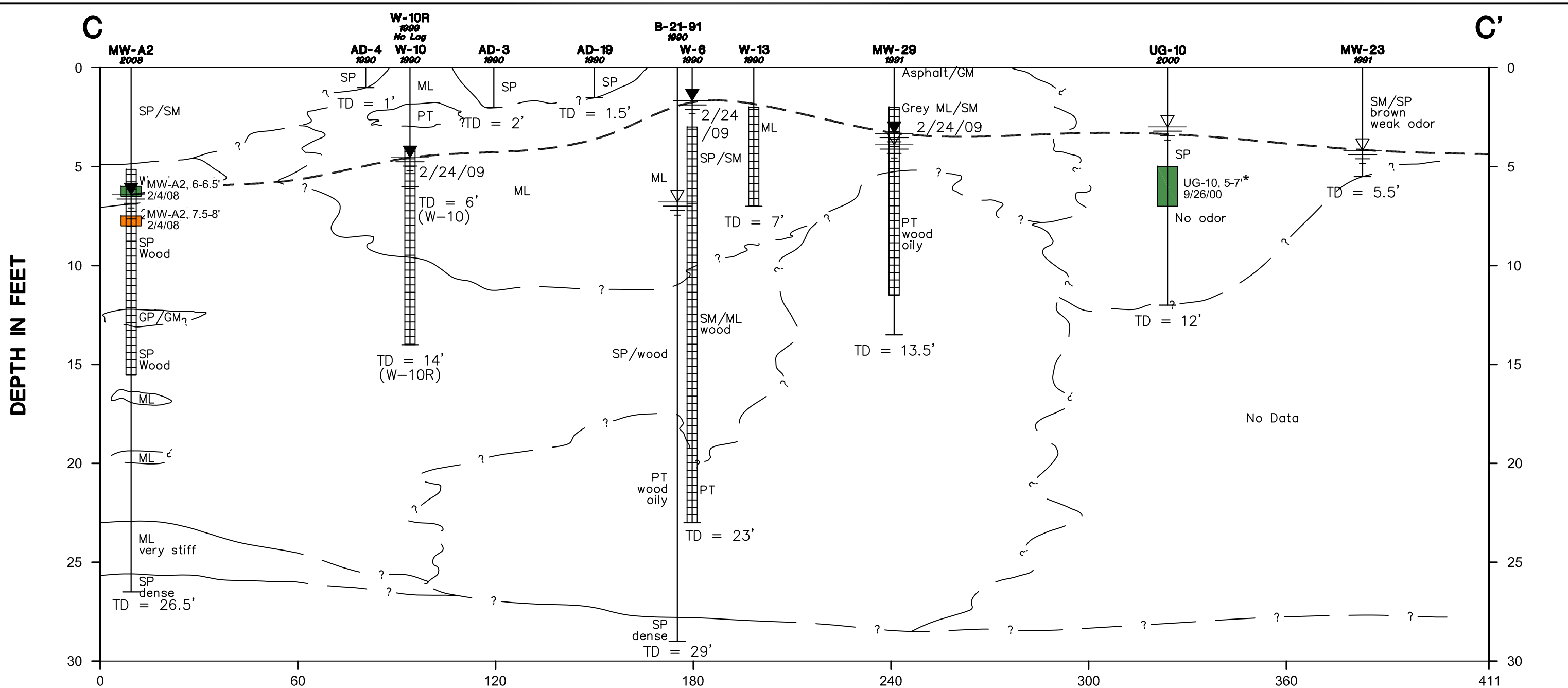

**LEGEND**

12/26/91 Static water level measured after drilling and date measured

Water level during drilling

Unconfined groundwater table

**AD-4 1990** Boring number and year installed

**MW-A2 2008** Well number and year installed

Screen interval

**TD = 1'** Total depth in feet

**TD = 26'** Total depth in feet

**TPH-G**

Detected ≥ 30 mg/kg

Detected < 30 mg/kg

Not detected

mg/kg Milligram per kilogram

UG-10, 5-7' 9/26/00 Sample depth and date collected

\* Sample was not analyzed for benzene

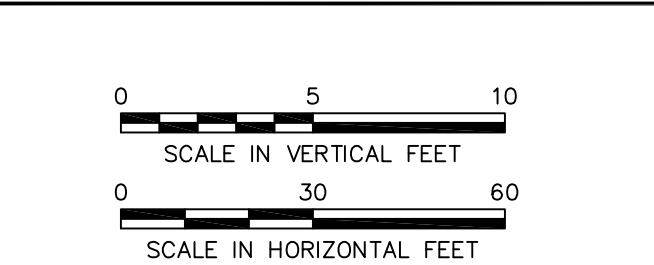

CLIENT LOGO

CLIENT:

**EXXONMOBIL AND AMERICAN DISTRIBUTING COMPANY**

**AMEC Earth & Environmental**  
11810 North Creek Parkway North  
Bothell, WA, U.S.A. 98011-8201

DWN BY: JRS  
CHK'D BY: AS  
DATUM: NONE  
PROJECTION: NONE  
SCALE: AS SHOWN

PROJECT: EXXONMOBIL/ADC PROPERTY  
ECOLOGY SITE ID 2728

TITLE: VERTICAL DISTRIBUTION OF TPH-G IN SOIL CROSS SECTION C-C'

DATE: AUGUST 2009  
PROJECT NO.: 9-915-15716-C  
REV. NO.:  
FIGURE No. 29

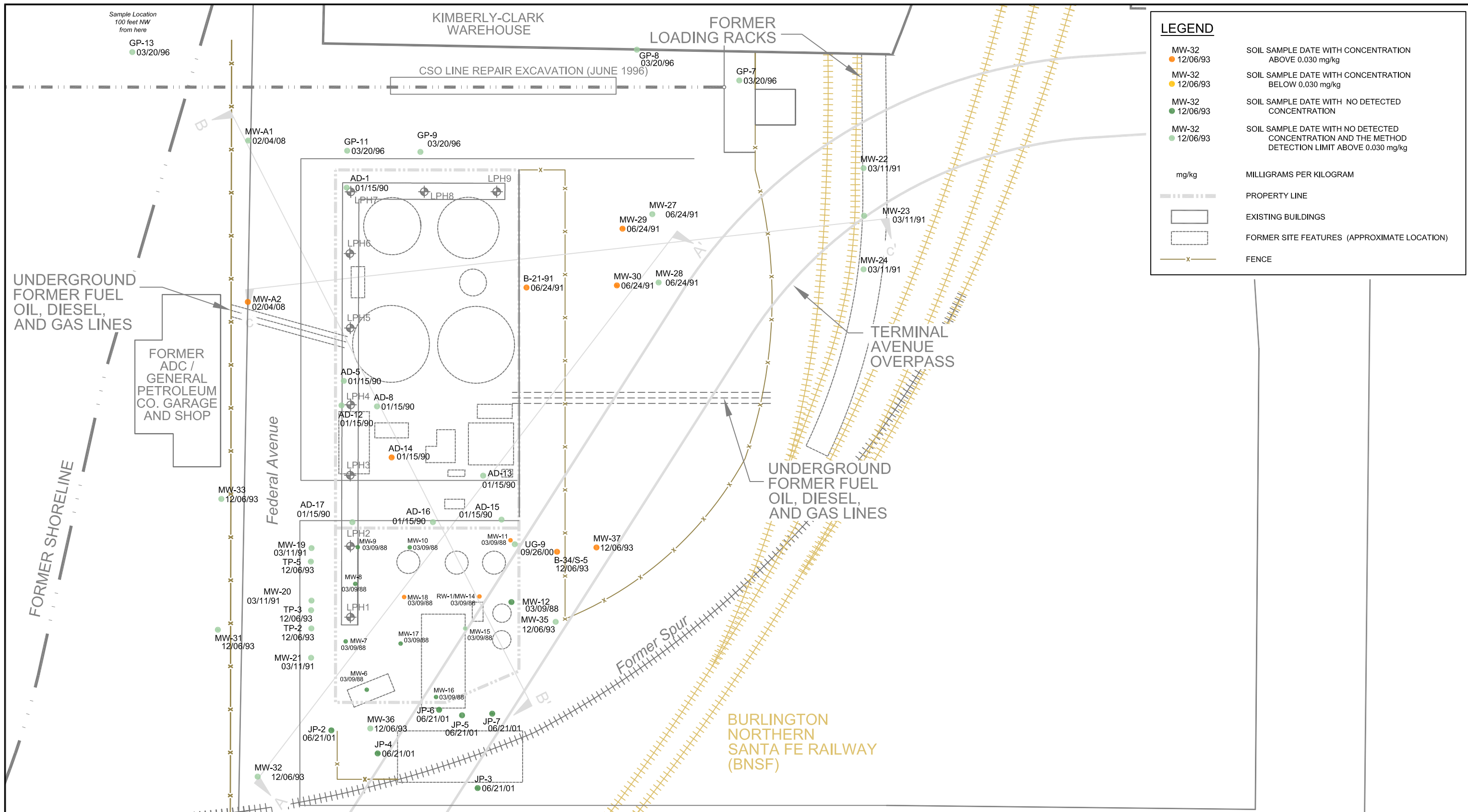

SOURCE: Modified from a map provided by City of Everett, ExxonMobil Oil Corporation and Environmental Resolution, Inc.

SCALE IN FEET

CLIENT LOGO

CLIENT:

**EXXONMOBIL AND AMERICAN DISTRIBUTING COMPANY**

**AMEC Earth & Environmental**  
 11810 North Creek Parkway North  
 Bothell, WA, U.S.A. 98011-8201

DWN BY: JRS / BRJ  
 CHK'D BY: AIS  
 DATUM: NONE  
 PROJECTION: NONE  
 SCALE: 1" = 60'

PROJECT

**EXXONMOBIL/ADC PROPERTY  
 ECOLOGY SITE ID 2728**

TITLE

**HORIZONTAL DISTRIBUTION  
 OF BENZENE IN SOIL**

DATE: AUGUST 2009  
 PROJECT NO: 9-915-15716-C  
 REV. NO.: 1  
 FIGURE No. 30

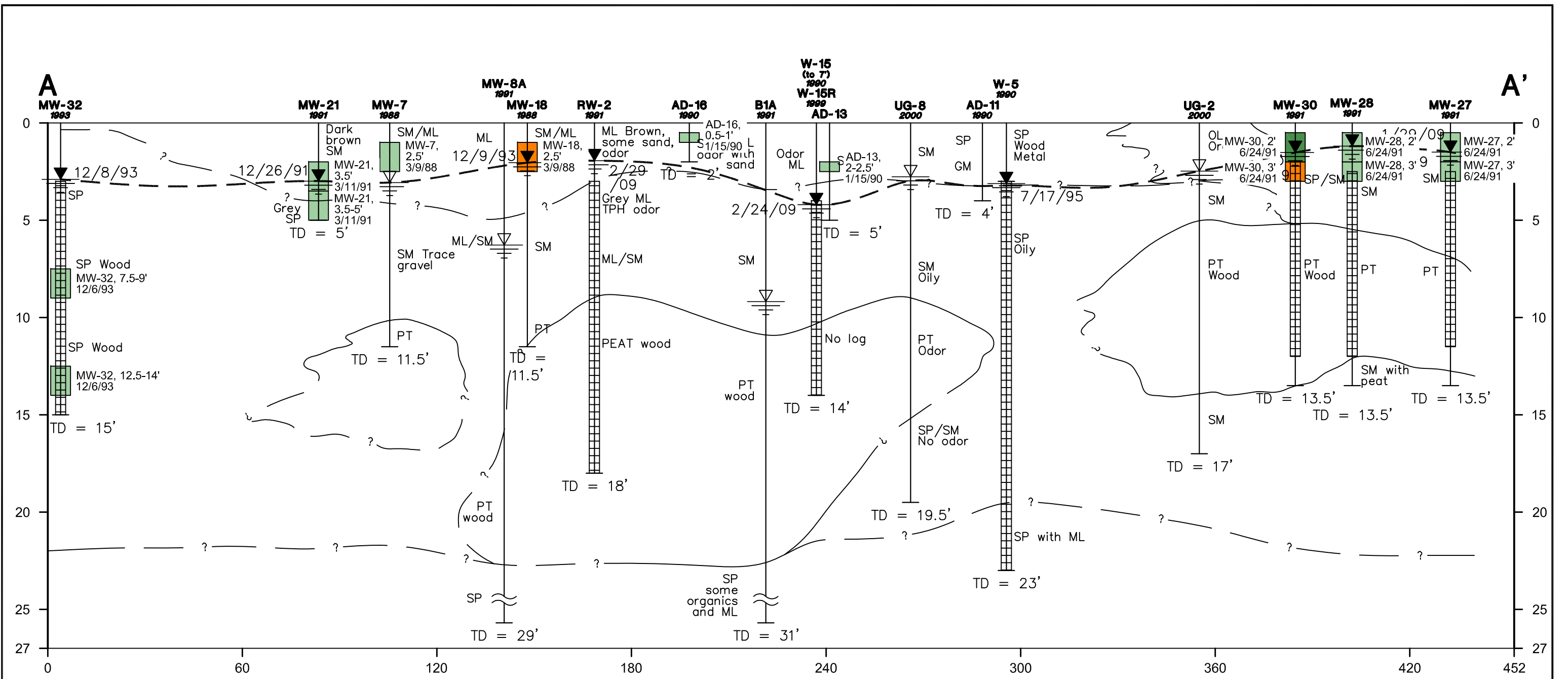

**LEGEND**

12/26/91 Static water level measured after drilling and date measured

Water level during drilling

Unconfined groundwater table

**AD-16** 1990 Boring number and year installed

**MW-30** 1991 Well number and year installed

Screen interval

TD = 2' Total depth in feet

TD = 15' Total depth in feet

**Benzene**

- Detected ≥ 0.030 mg/kg
- Detected < 0.030 mg/kg
- Not detected
- Not detected, but detection limit above 0.030 mg/kg

mg/kg Milligram per kilogram

MW-27, 2' 6/24/91 Sample depth and date collected

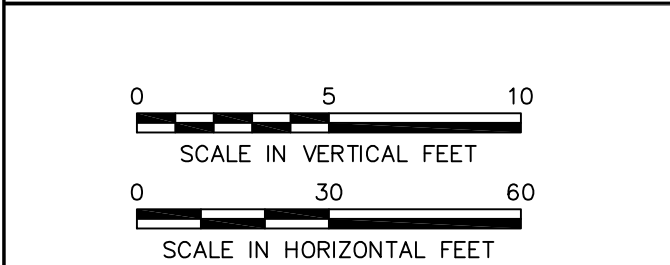

CLIENT LOGO

CLIENT:

**EXXONMOBIL AND AMERICAN DISTRIBUTING COMPANY**

**AMEC Earth & Environmental**  
11810 North Creek Parkway North  
Bothell, WA, U.S.A. 98011-8201

DWN BY: JRS

CHK'D BY: AS

DATUM: NONE

PROJECTION: NONE

SCALE: AS SHOWN

PROJECT

**EXXONMOBIL/ADC PROPERTY**  
ECOLOGY SITE ID 2728

TITLE

**VERTICAL DISTRIBUTION OF BENZENE IN SOIL CROSS SECTION A-A'**

DATE: JUNE 2009

PROJECT NO: 9-915-15716-C

REV. NO.:

FIGURE No. **31**

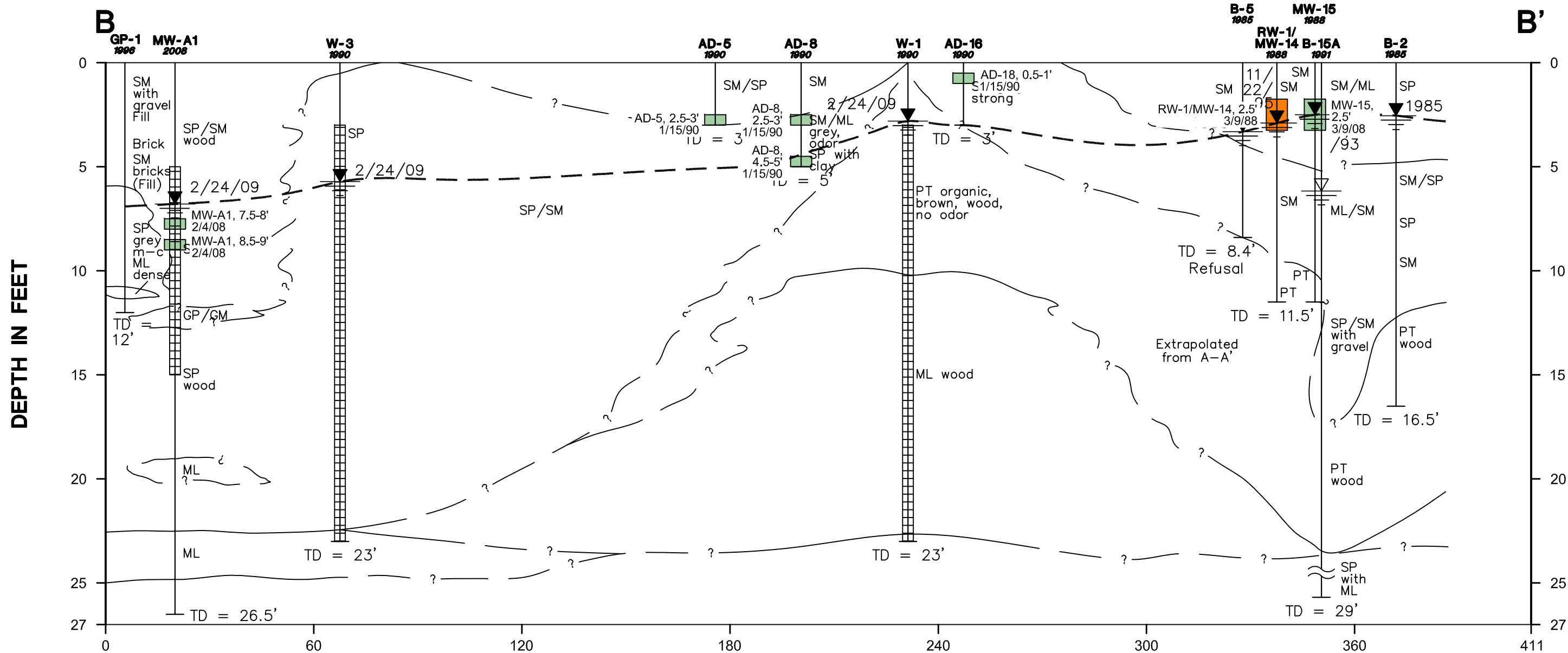

**LEGEND**

12/26/91 Static water level measured after drilling and date measured

Water level during drilling

Unconfined groundwater table

**AD-5 1990** Boring number and year installed TD = 3' Total depth in feet

**MW-A1 2008** Well number and year installed Screen interval TD = 23' Total depth in feet

**Benzene**

- Detected ≥ 0.030 mg/kg
- Detected < 0.030 mg/kg
- Not detected
- Not detected, but detection limit above 0.030 mg/kg

mg/kg Milligram per kilogram

MW-15, 2.5' 3/9/08 Sample depth and date collected

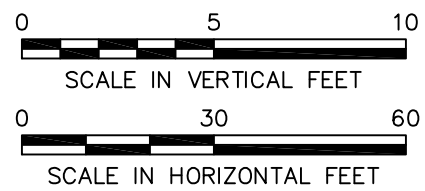

CLIENT LOGO

CLIENT:

**EXXONMOBIL AND AMERICAN DISTRIBUTING COMPANY**

**AMEC Earth & Environmental**  
11810 North Creek Parkway North  
Bothell, WA, U.S.A. 98011-8201

DWN BY: JRS

CHK'D BY: AS

DATUM: NONE

PROJECTION: NONE

SCALE: AS SHOWN

PROJECT

**EXXONMOBIL/ADC PROPERTY**  
ECOLOGY SITE ID 2728

TITLE

**VERTICAL DISTRIBUTION OF BENZENE IN SOIL CROSS SECTION B-B'**

DATE: JUNE 2009

PROJECT NO: 9-915-15716-C

REV. NO.:

FIGURE No. 32

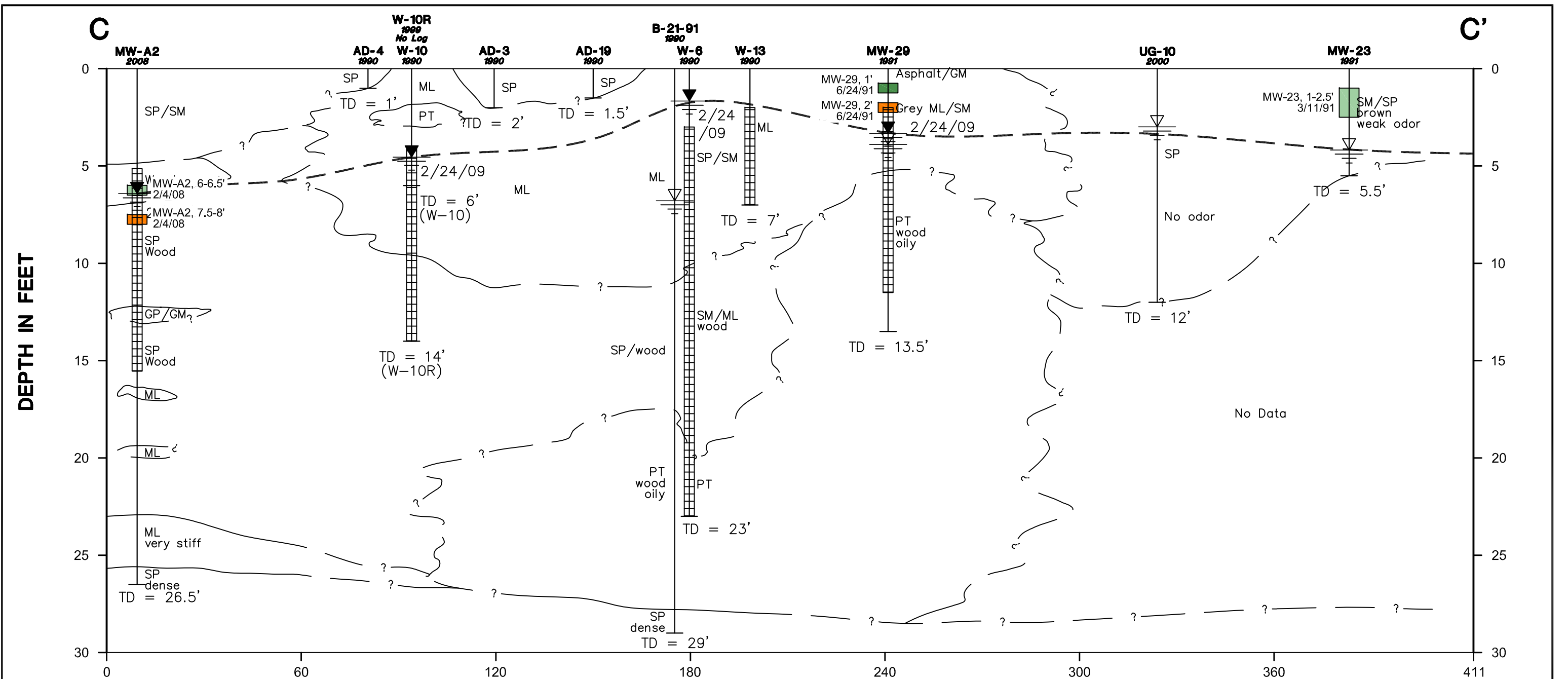

**LEGEND**

12/26/91 Static water level measured after drilling and date measured

Water level during drilling

Unconfined groundwater table

**AD-4 1990** Boring number and year installed

**MW-A2 2008** Well number and year installed

Screen interval

**TD = 1'** Total depth in feet

**TD = 26'** Total depth in feet

**Benzene**

- Detected ≥ 0.030 mg/kg
- Detected < 0.030 mg/kg
- Not detected
- Not detected, but detection limit above 0.030 mg/kg

mg/kg Milligram per kilogram

MW-23, 1-2.5' 3/11/91 Sample depth and date collected

 SCALE IN VERTICAL FEET  SCALE IN HORIZONTAL FEET	CLIENT LOGO  CLIENT: <b>EXXONMOBIL AND AMERICAN DISTRIBUTING COMPANY</b>  <b>AMEC Earth &amp; Environmental</b> 11810 North Creek Parkway North Bothell, WA, U.S.A. 98011-8201	DWN BY: JRS CHK'D BY: AS DATUM: NONE PROJECTION: NONE SCALE: AS SHOWN	PROJECT <b>EXXONMOBIL/ADC PROPERTY</b> <b>ECOLOGY SITE ID 2728</b>  TITLE <b>VERTICAL DISTRIBUTION OF BENZENE IN SOIL CROSS SECTION C-C'</b>	DATE: JUNE 2009 PROJECT NO: 9-915-15716-C REV. NO.: FIGURE No. <b>33</b>



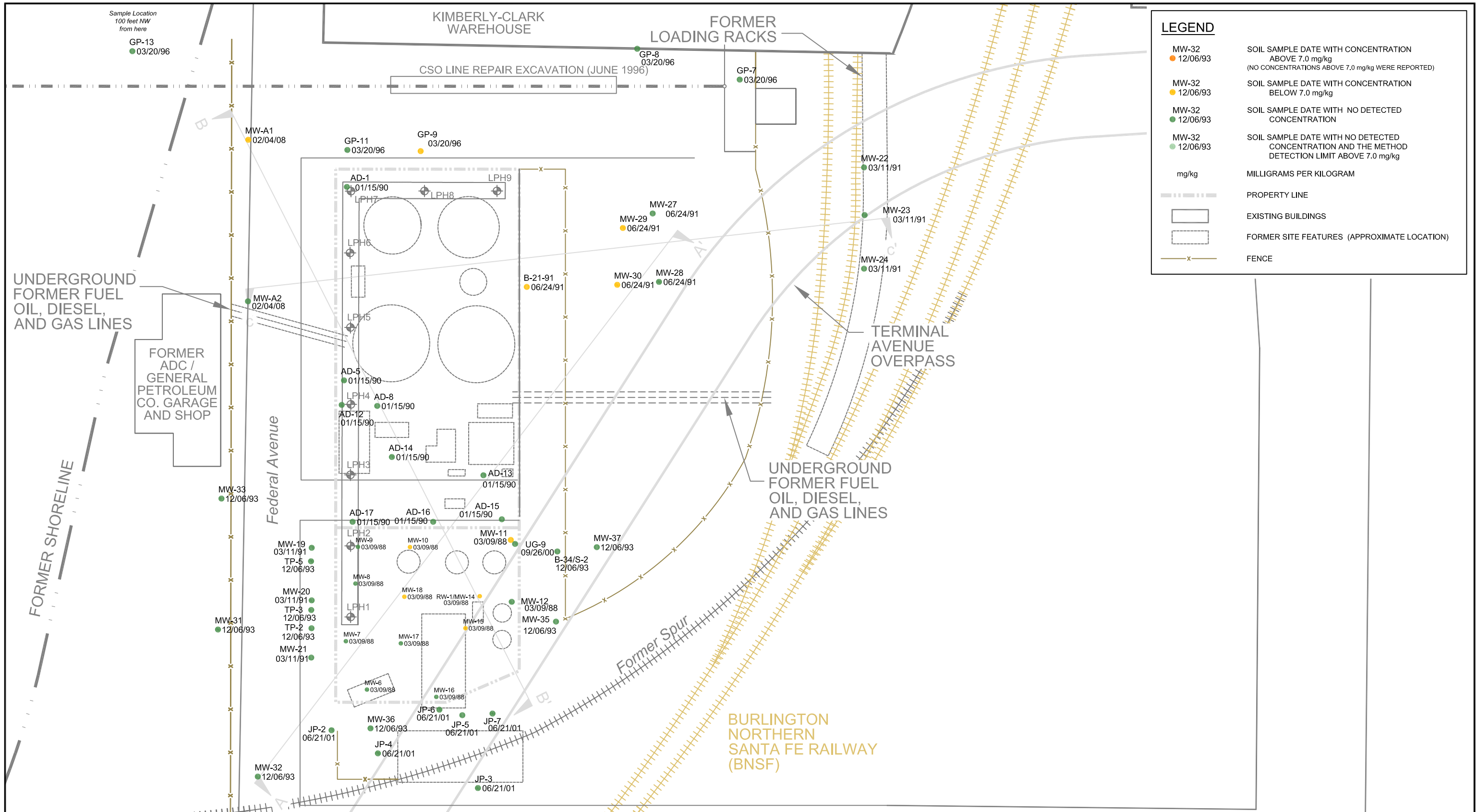

SOURCE: Modified from a map provided by City of Everett, ExxonMobil Oil Corporation and Environmental Resolution, Inc.

SCALE IN FEET

CLIENT LOGO

CLIENT:

**EXXONMOBIL AND AMERICAN DISTRIBUTING COMPANY**

**AMEC Earth & Environmental**  
 11810 North Creek Parkway North  
 Bothell, WA, U.S.A. 98011-8201

DWN BY: JRS / BRJ  
 CHK'D BY: AIS  
 DATUM: NONE  
 PROJECTION: NONE  
 SCALE: 1" = 60'

PROJECT

**EXXONMOBIL/ADC PROPERTY  
 ECOLOGY SITE ID 2728**

TITLE

**HORIZONTAL DISTRIBUTION  
 OF TOLUENE IN SOIL**

DATE: AUGUST 2009  
 PROJECT NO: 9-915-15716-C  
 REV. NO.: 1  
 FIGURE No. 34

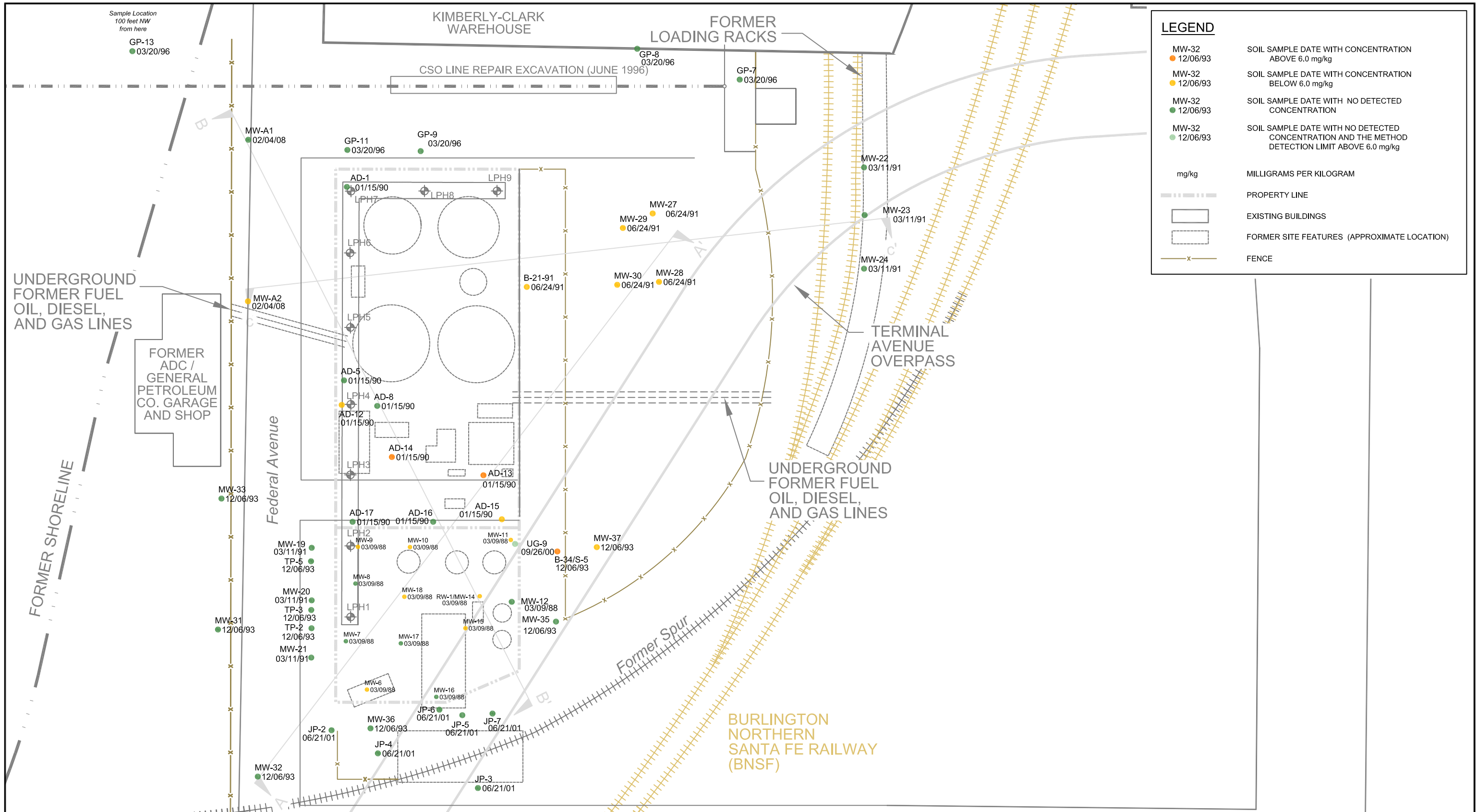

LEGEND	
MW-32 ● 12/06/93	SOIL SAMPLE DATE WITH CONCENTRATION ABOVE 6.0 mg/kg
MW-32 ● 12/06/93	SOIL SAMPLE DATE WITH CONCENTRATION BELOW 6.0 mg/kg
MW-32 ● 12/06/93	SOIL SAMPLE DATE WITH NO DETECTED CONCENTRATION
MW-32 ● 12/06/93	SOIL SAMPLE DATE WITH NO DETECTED CONCENTRATION AND THE METHOD DETECTION LIMIT ABOVE 6.0 mg/kg
mg/kg	MILLIGRAMS PER KILOGRAM
---	PROPERTY LINE
▭	EXISTING BUILDINGS
▭	FORMER SITE FEATURES (APPROXIMATE LOCATION)
—x—	FENCE

SOURCE: Modified from a map provided by City of Everett, ExxonMobil Oil Corporation and Environmental Resolution, Inc.   SCALE IN FEET	CLIENT LOGO 	CLIENT: <b>EXXONMOBIL AND AMERICAN DISTRIBUTING COMPANY</b>	DWN BY: JRS / BRJ CHK'D BY: AIS DATUM: NONE PROJECTION: NONE SCALE: 1" = 60'	PROJECT <b>EXXONMOBIL/ADC PROPERTY ECOLOGY SITE ID 2728</b>	DATE: AUGUST 2009 PROJECT NO: 9-915-15716-C REV. NO.: 1 FIGURE No. 35
		AMEC Earth & Environmental 11810 North Creek Parkway North Bothell, WA, U.S.A. 98011-8201 	TITLE <b>HORIZONTAL DISTRIBUTION OF ETHYLBENZENE IN SOIL</b>		

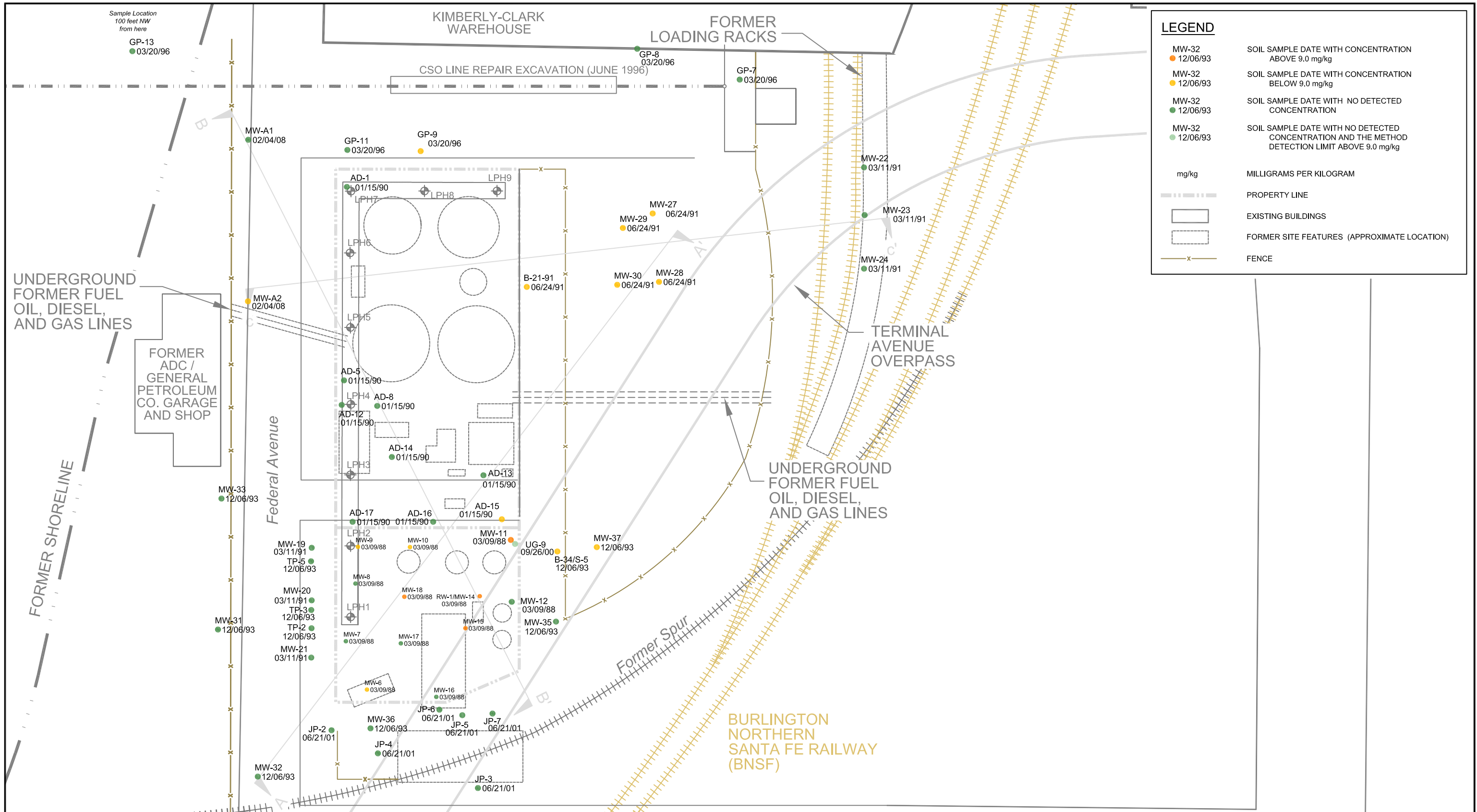

LEGEND	
MW-32 ● 12/06/93	SOIL SAMPLE DATE WITH CONCENTRATION ABOVE 9.0 mg/kg
MW-32 ● 12/06/93	SOIL SAMPLE DATE WITH CONCENTRATION BELOW 9.0 mg/kg
MW-32 ● 12/06/93	SOIL SAMPLE DATE WITH NO DETECTED CONCENTRATION
MW-32 ● 12/06/93	SOIL SAMPLE DATE WITH NO DETECTED CONCENTRATION AND THE METHOD DETECTION LIMIT ABOVE 9.0 mg/kg
mg/kg	MILLIGRAMS PER KILOGRAM
---	PROPERTY LINE
▭	EXISTING BUILDINGS
▭	FORMER SITE FEATURES (APPROXIMATE LOCATION)
—x—	FENCE

SOURCE: Modified from a map provided by City of Everett, ExxonMobil Oil Corporation and Environmental Resolution, Inc.   SCALE IN FEET	CLIENT LOGO 	CLIENT: <b>EXXONMOBIL AND AMERICAN DISTRIBUTING COMPANY</b>	DWN BY: JRS / BRJ CHK'D BY: AIS DATUM: NONE PROJECTION: NONE SCALE: 1" = 60'	PROJECT <b>EXXONMOBIL/ADC PROPERTY ECOLOGY SITE ID 2728</b>	DATE: AUGUST 2009 PROJECT NO: 9-915-15716-C REV. NO.: 1 FIGURE No. 36
		AMEC Earth & Environmental 11810 North Creek Parkway North Bothell, WA, U.S.A. 98011-8201 	TITLE <b>HORIZONTAL DISTRIBUTION OF TOTAL XYLENE IN SOIL</b>		

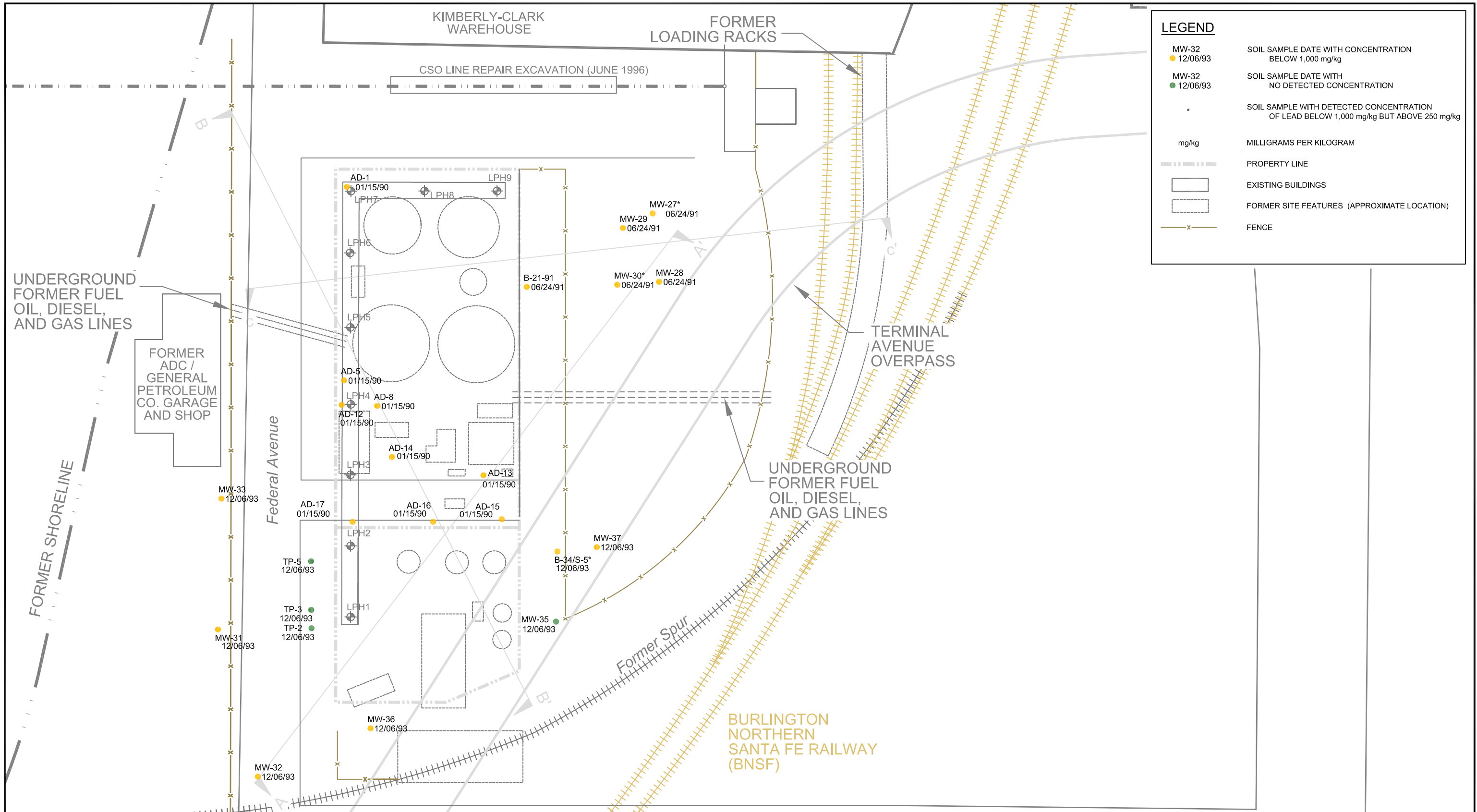

SOURCE: Modified from a map provided by City of Everett, ExxonMobil Oil Corporation and Environmental Resolution, Inc.

SCALE IN FEET

CLIENT LOGO

CLIENT:

**EXXONMOBIL AND AMERICAN DISTRIBUTING COMPANY**

**AMEC Earth & Environmental**  
 11810 North Creek Parkway North  
 Bothell, WA, U.S.A. 98011-8201

DWN BY:	JRS / BRJ
CHK'D BY:	AMS
DATUM:	NONE
PROJECTION:	NONE
SCALE:	1" = 60'

PROJECT	<b>EXXONMOBIL/ADC PROPERTY ECOLOGY SITE ID 2728</b>
TITLE	<b>HORIZONTAL DISTRIBUTION OF LEAD IN SOIL</b>

DATE:	AUGUST 2009
PROJECT NO.:	9-915-15716-C
REV. NO.:	1
FIGURE No.	37

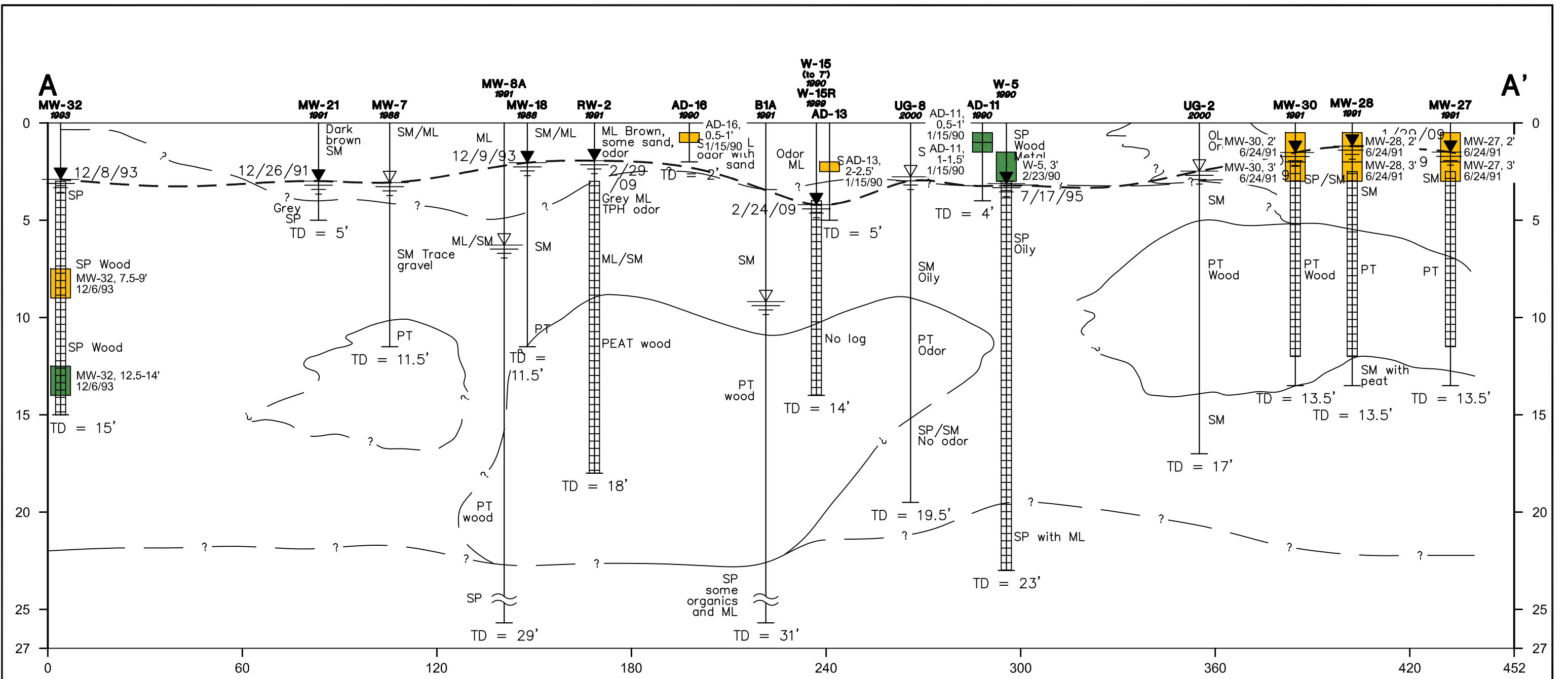

**LEGEND**

12/26/91 Static water level measured after drilling and date measured

Water level during drilling

Unconfined groundwater table

**AD-16** Boring number and year installed

**MW-30** Well number and year installed

Screen interval

**TD = 2'** Total depth in feet

**TD = 15'** Total depth in feet

**Lead**

- Detected  $\geq 1,000$  mg/kg
- Detected  $< 1,000$  mg/kg
- Not detected

mg/kg Milligram per kilogram

MW-28, 2' 6/24/91 Sample depth and date collected

 SCALE IN VERTICAL FEET  SCALE IN HORIZONTAL FEET	CLIENT LOGO	CLIENT:	DWN BY: JRS	PROJECT	DATE: AUGUST 2009
	EXXONMOBIL AND AMERICAN DISTRIBUTING COMPANY		CHK'D BY: AS	EXXONMOBIL/ADC PROPERTY ECOLOGY SITE ID 2728	PROJECT NO: 9-915-15716-C
AMEC Earth & Environmental 11810 North Creek Parkway North Bothell, WA, U.S.A. 98011-8201			DATUM: NONE	TITLE	REV. NO.:
			PROJECTION: NONE	VERTICAL DISTRIBUTION OF LEAD IN SOIL CROSS SECTION A-A'	FIGURE No. 38
			SCALE: AS SHOWN		

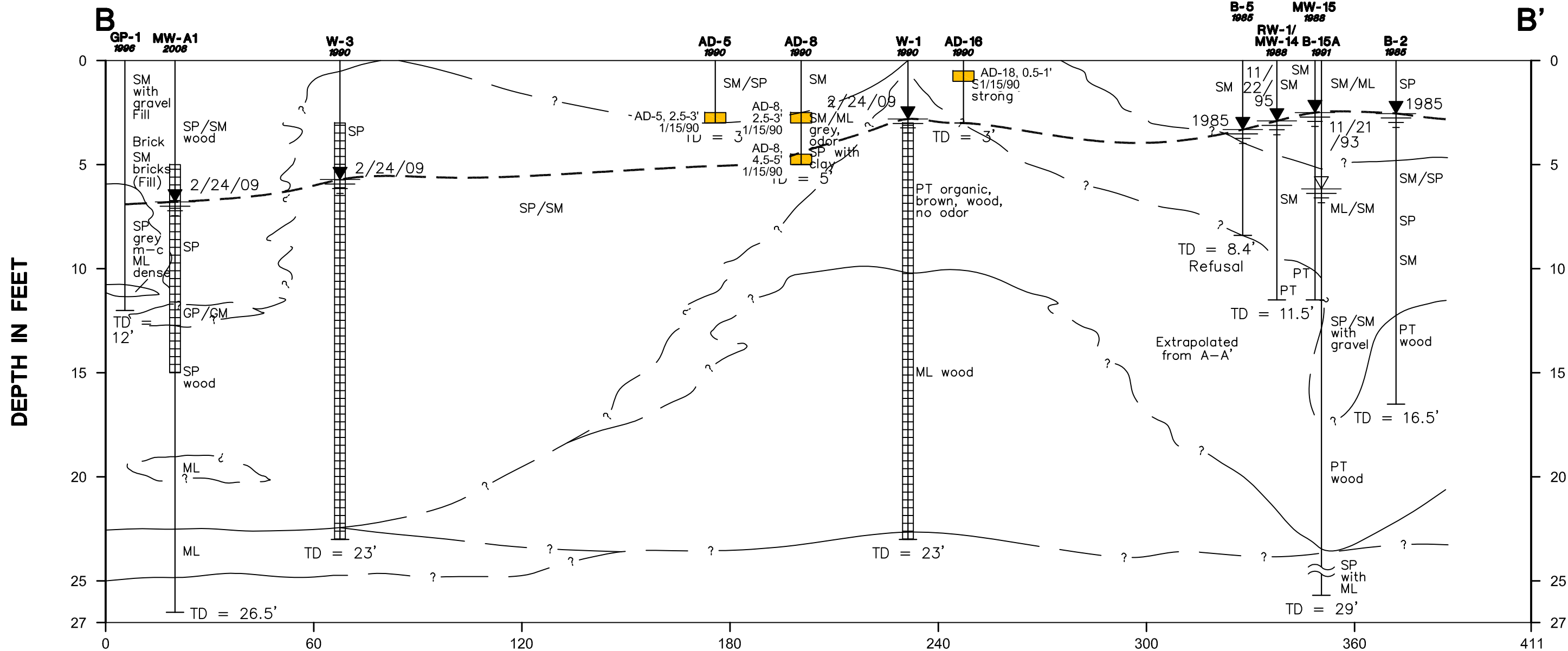

**LEGEND**

12/26/91 Static water level measured after drilling and date measured

Water level during drilling

--- Unconfined groundwater table

**AD-5 1990** Boring number and year installed

**MW-A1 2008** Well number and year installed

Screen interval

**TD = 3'** Total depth in feet

**TD = 23'** Total depth in feet

**Lead**

Detected ≥ 1,000 mg/kg

Detected < 1,000 mg/kg

Not detected

mg/kg Milligram per kilogram

AD-18, 0.5-1' 1/15/90 Sample depth and date collected

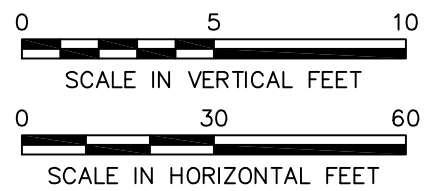

CLIENT LOGO

CLIENT:

**EXXONMOBIL AND AMERICAN DISTRIBUTING COMPANY**

**AMEC Earth & Environmental**  
 11810 North Creek Parkway North  
 Bothell, WA, U.S.A. 98011-8201

DWN BY: JRS

CHK'D BY: AS

DATUM: NONE

PROJECTION: NONE

SCALE: AS SHOWN

PROJECT

**EXXONMOBIL/ADC PROPERTY**  
**ECOLOGY SITE ID 2728**

TITLE

**VERTICAL DISTRIBUTION OF LEAD IN SOIL CROSS SECTION B-B'**

DATE: AUGUST 2009

PROJECT NO: 9-915-15716-C

REV. NO.:

FIGURE No. **39**

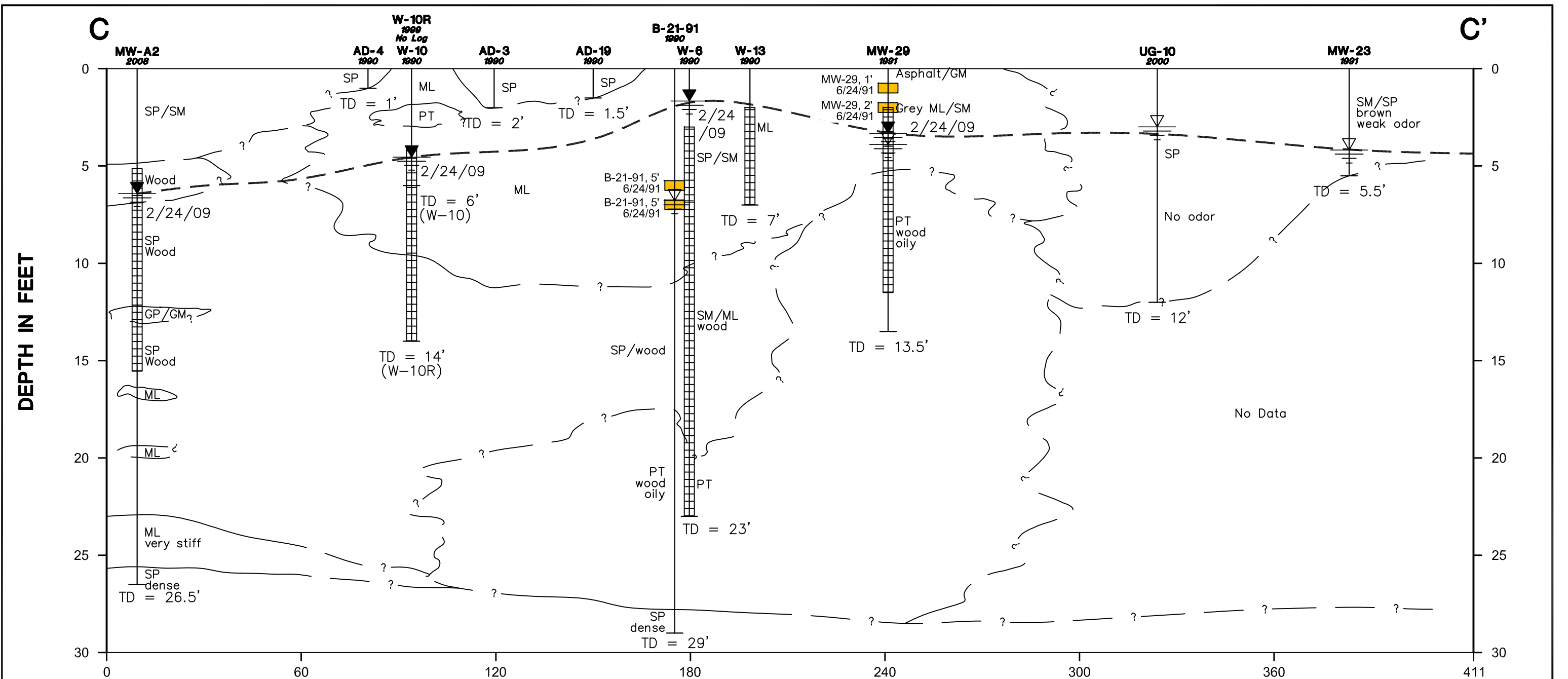

**LEGEND**

12/26/91 Static water level measured after drilling and date measured

Water level during drilling

Unconfined groundwater table

AD-4 1990 Boring number and year installed

TD = 1' Total depth in feet

MW-A2 2008 Well number and year installed

TD = 26' Total depth in feet

Screen interval

**Lead**

Detected ≥ 1,000 mg/kg

Detected < 1,000 mg/kg

Not detected

mg/kg Milligram per kilogram

MW-29, 2' 6/24/91 Sample depth and date collected

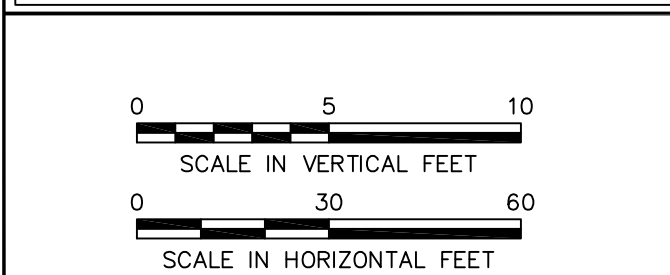

CLIENT LOGO

CLIENT:

**EXXONMOBIL AND AMERICAN DISTRIBUTING COMPANY**

AMEC Earth & Environmental  
11810 North Creek Parkway North  
Bothell, WA, U.S.A. 98011-8201

DWN BY: JRS  
CHK'D BY: AS  
DATUM: NONE  
PROJECTION: NONE  
SCALE: AS SHOWN

PROJECT: EXXONMOBIL/ADC PROPERTY  
ECOLOGY SITE ID 2728

TITLE: VERTICAL DISTRIBUTION OF LEAD IN SOIL  
CROSS SECTION C-C'

DATE: AUGUST 2009  
PROJECT NO.: 9-915-15716-C  
REV. NO.:  
FIGURE No. 40

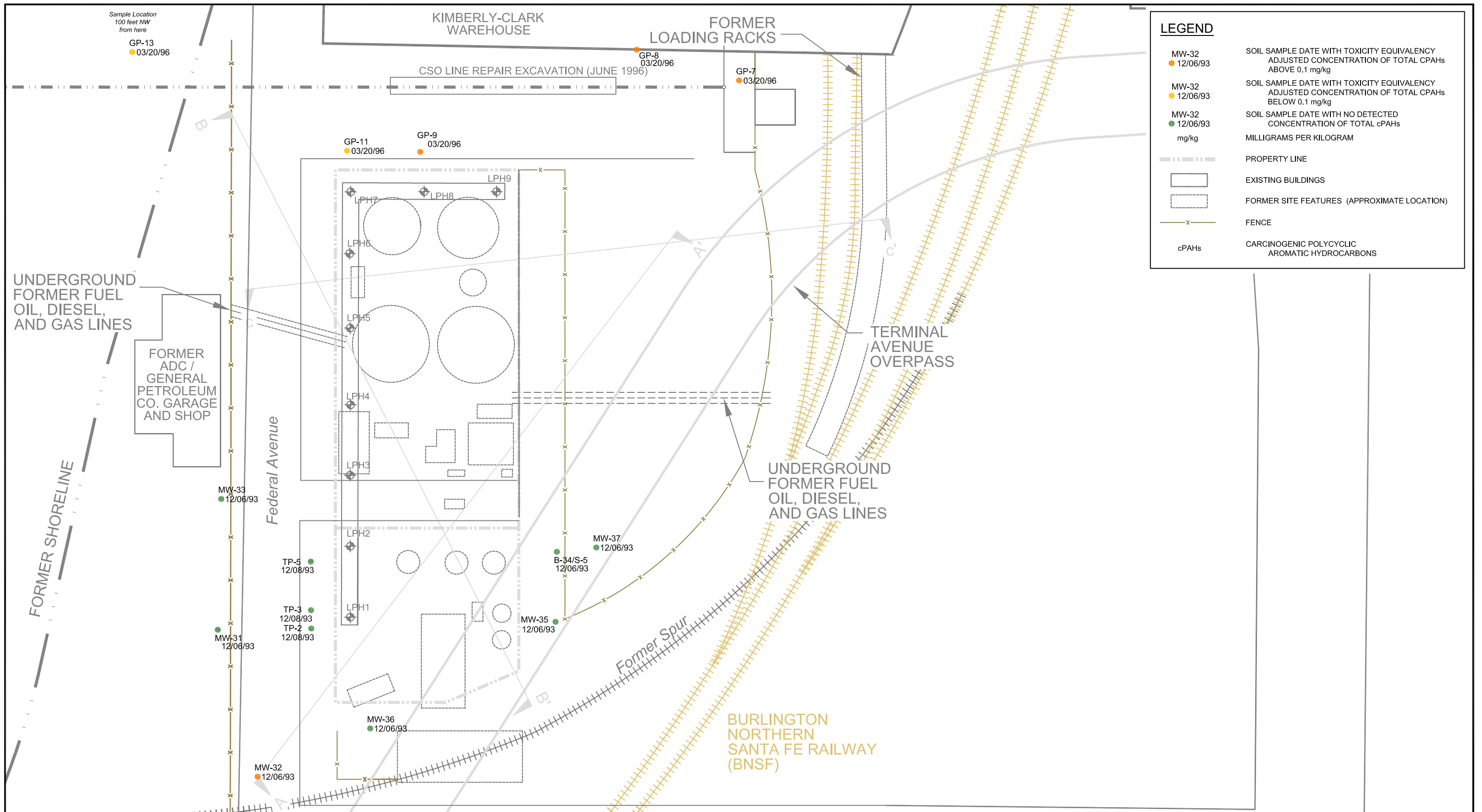

SOURCE: Modified from a map provided by City of Everett, ExxonMobil Oil Corporation and Environmental Resolution, Inc.

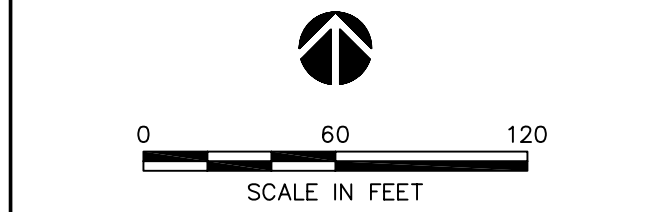

CLIENT LOGO

CLIENT:  
**EXXONMOBIL AND AMERICAN DISTRIBUTING COMPANY**

**AMEC Earth & Environmental**  
11810 North Creek Parkway North  
Bothell, WA, U.S.A. 98011-8201

DWN BY: JRS / BRJ  
CHK'D BY: AIS  
DATUM: NONE  
PROJECTION: NONE  
SCALE: 1" = 60'

PROJECT  
**EXXONMOBIL/ADC PROPERTY  
ECOLOGY SITE ID 2728**

TITLE  
**HORIZONTAL DISTRIBUTION  
OF ADJUSTED TOTAL cPAHs  
CONCENTRATION IN SOIL**

DATE:  
AUGUST 2009

PROJECT NO:  
9-915-15716-C

REV. NO.:  
1

FIGURE No.  
41



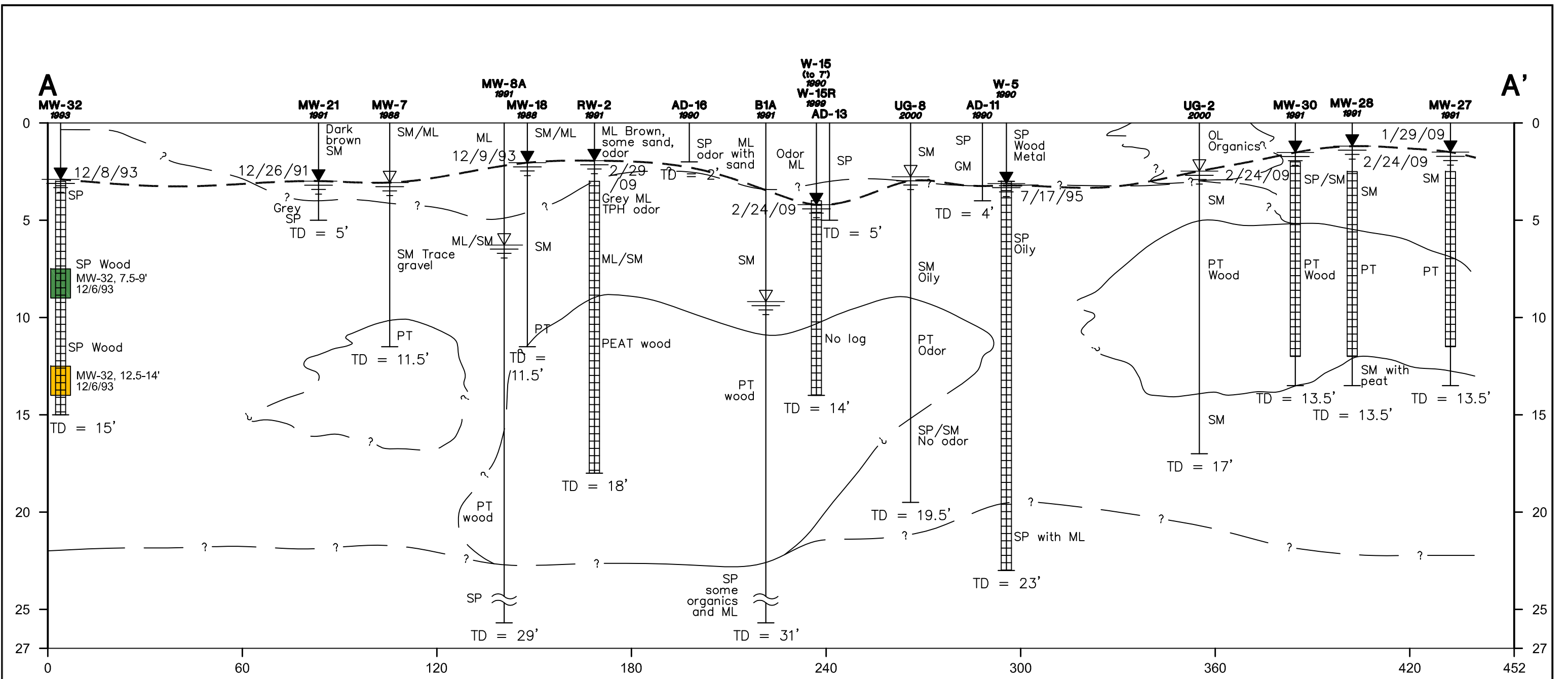

**LEGEND**

12/26/91 Static water level measured after drilling and date measured

Water level during drilling

--- Unconfined groundwater table

**AD-16 1990** Boring number and year installed

**MW-30 1991** Well number and year installed

Screen interval

**TD = 2'** Total depth in feet

**TD = 15'** Total depth in feet

**CARCINOGENIC POLYCYCLIC AROMATIC HYDROCARBON**  
(Toxicity Equivalent Adjusted Concentration)

Detected ≥ 2.0 mg/kg

Detected < 2.0 mg/kg

Not detected

mg/kg Milligram per kilogram

UG-8, 5-7' 9/26/00 Sample depth and date collected

 SCALE IN VERTICAL FEET   SCALE IN HORIZONTAL FEET	CLIENT LOGO  CLIENT: <b>EXXONMOBIL AND AMERICAN DISTRIBUTING COMPANY</b>	DWN BY: JRS CHK'D BY: AS DATUM: NONE PROJECTION: NONE SCALE: AS SHOWN	PROJECT <b>EXXONMOBIL/ADC PROPERTY</b> ECOLOGY SITE ID 2728	DATE: JUNE 2009 PROJECT NO: 9-915-15716-C
		<b>AMEC Earth &amp; Environmental</b> 11810 North Creek Parkway North Bothell, WA, U.S.A. 98011-8201 	TITLE <b>VERTICAL DISTRIBUTION OF TOXICITY-ADJUSTED TOTAL cPAHS CONCENTRATIONS IN SOIL CROSS SECTION A-A'</b>	REV. NO.: FIGURE No. <b>42</b>

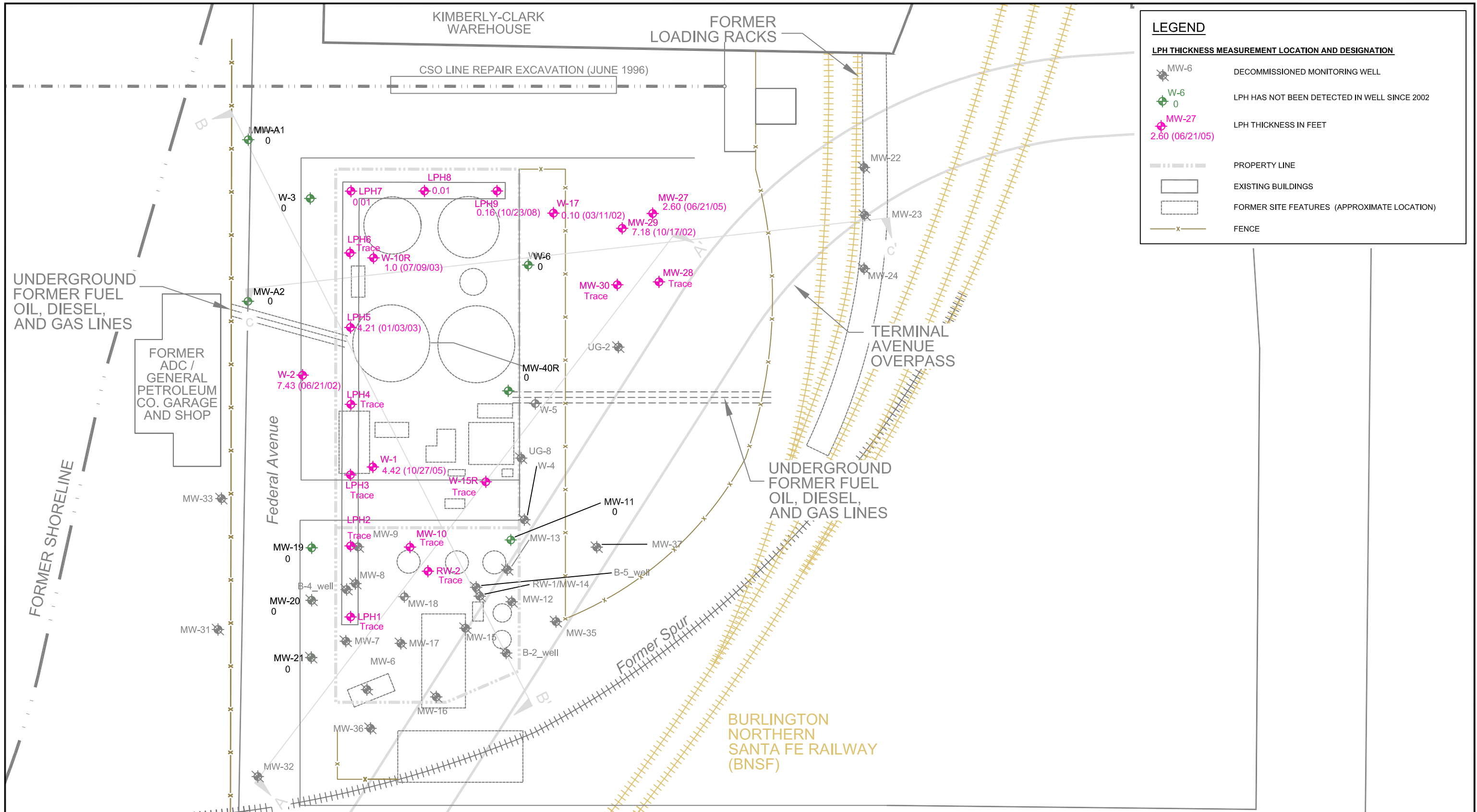

LEGEND	
LPH THICKNESS MEASUREMENT LOCATION AND DESIGNATION	
	DECOMMISSIONED MONITORING WELL
	LPH HAS NOT BEEN DETECTED IN WELL SINCE 2002
	LPH THICKNESS IN FEET
	2.60 (06/21/05)
	PROPERTY LINE
	EXISTING BUILDINGS
	FORMER SITE FEATURES (APPROXIMATE LOCATION)
	FENCE

SOURCE: Modified from a map provided by City of Everett, ExxonMobil Oil Corporation and Environmental Resolution, Inc.   SCALE IN FEET	CLIENT LOGO 	CLIENT: <b>EXXONMOBIL AND AMERICAN DISTRIBUTING COMPANY</b>	DWN BY: JRS / BRJ CHK'D BY: AIS/MS DATUM: NONE PROJECTION: NONE SCALE: 1" = 60'	PROJECT <b>EXXONMOBIL/ADC PROPERTY ECOLOGY SITE ID 2728</b>	DATE: AUGUST 2009 PROJECT NO: 9-915-15716-C REV. NO.: 1 FIGURE No. 43
		AMEC Earth & Environmental 11810 North Creek Parkway North Bothell, WA, U.S.A. 98011-8201 	TITLE <b>LIQUID-PHASE PETROLEUM HYDROCARBON MAXIMUM THICKNESS SINCE 2002</b>		

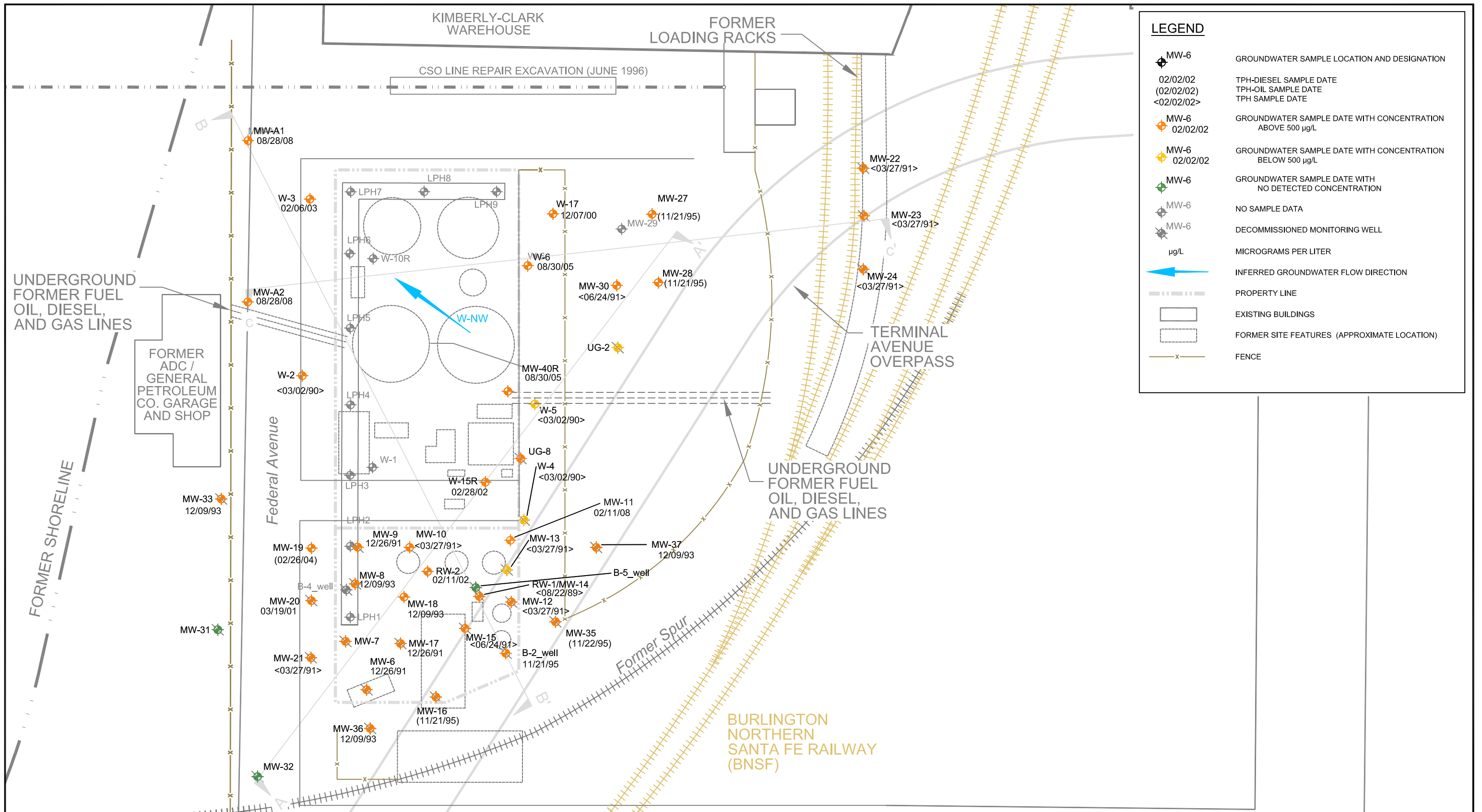

SOURCE: Modified from a map provided by City of Everett, ExxonMobil Oil Corporation and Environmental Resolution, Inc.  0 60 120 SCALE IN FEET	CLIENT LOGO 	CLIENT: <b>EXXONMOBIL AND AMERICAN DISTRIBUTING COMPANY</b>	DWN BY: JRS / BRJ CHK'D BY: AIS/MS DATUM: NONE PROJECTION: NONE SCALE: 1" = 60'	PROJECT <b>EXXONMOBIL/ADC PROPERTY ECOLOGY SITE ID 2728</b>	DATE: AUGUST 2009 PROJECT NO: 9-915-15716-C REV. NO.: 1
		AMEC Earth & Environmental 11810 North Creek Parkway North Bothell, WA, U.S.A. 98011-8201 	TITLE <b>HISTORICAL DISTRIBUTION OF TPH-D, TPH-O, AND TPH IN GROUNDWATER MAXIMUM DETECTED VALUE</b>	FIGURE No. <b>44</b>	

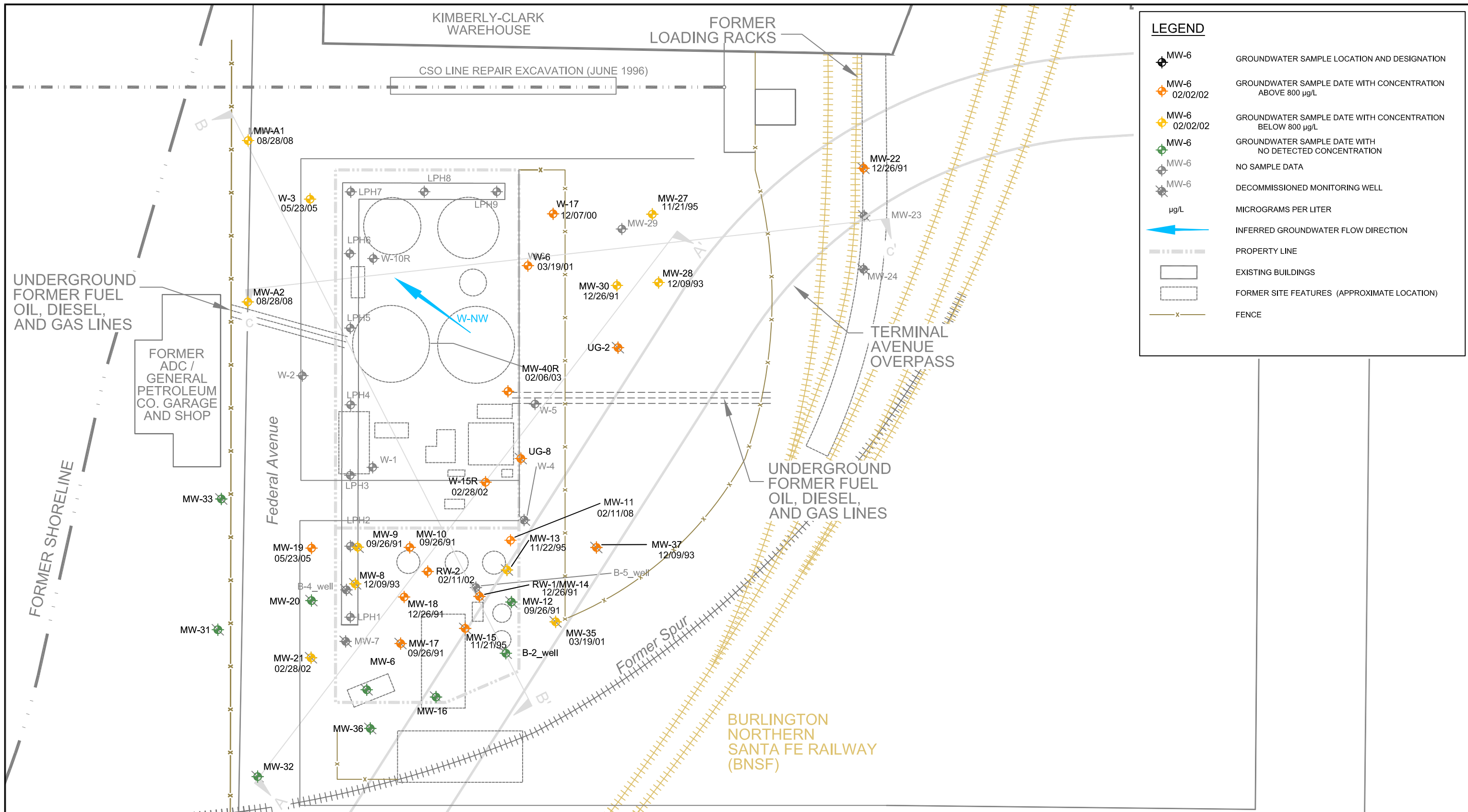

SOURCE: Modified from a map provided by City of Everett, ExxonMobil Oil Corporation and Environmental Resolution, Inc.

SCALE IN FEET

CLIENT LOGO

CLIENT:

**EXXONMOBIL AND AMERICAN DISTRIBUTING COMPANY**

**AMEC Earth & Environmental**  
 11810 North Creek Parkway North  
 Bothell, WA, U.S.A. 98011-8201

DWN BY: JRS / BRJ  
 CHK'D BY: AIS/MS  
 DATUM: NONE  
 PROJECTION: NONE  
 SCALE: 1" = 60'

PROJECT

**EXXONMOBIL/ADC PROPERTY  
 ECOLOGY SITE ID 2728**

TITLE

**HISTORICAL DISTRIBUTION OF  
 TPH-G IN GROUNDWATER  
 MAXIMUM DETECTED VALUE**

DATE: AUGUST 2009  
 PROJECT NO: 9-915-15716-C  
 REV. NO.: 1  
 FIGURE No. 45

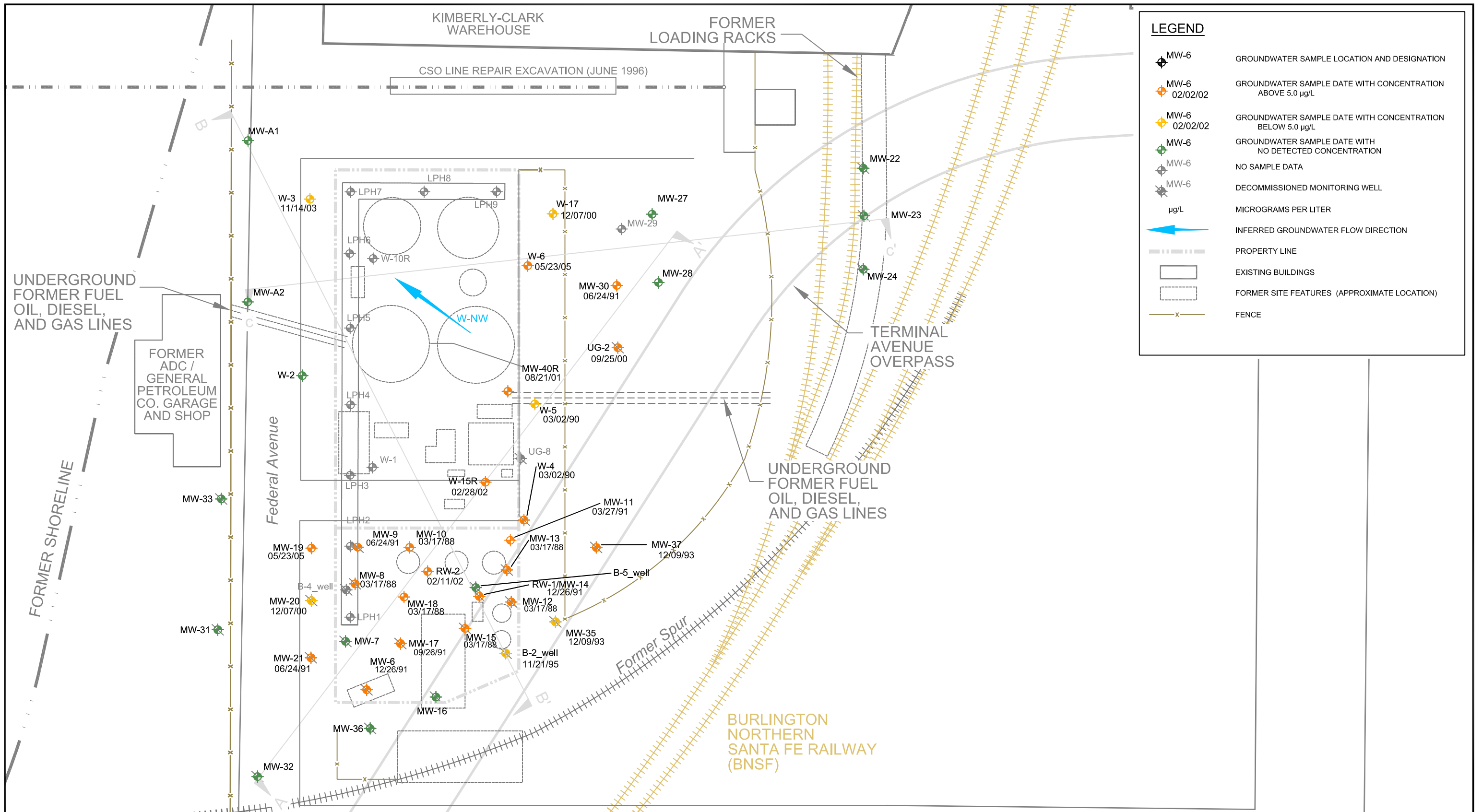

SOURCE: Modified from a map provided by City of Everett, ExxonMobil Oil Corporation and Environmental Resolution, Inc.

SCALE IN FEET

CLIENT LOGO

CLIENT:

**EXXONMOBIL AND AMERICAN DISTRIBUTING COMPANY**

**AMEC Earth & Environmental**

11810 North Creek Parkway North  
Bothell, WA, U.S.A. 98011-8201

DWN BY: JRS / BRJ

CHK'D BY: AIS/MS

DATUM: NONE

PROJECTION: NONE

SCALE: 1" = 60'

PROJECT

**EXXONMOBIL/ADC PROPERTY  
ECOLOGY SITE ID 2728**

TITLE

**HISTORICAL DISTRIBUTION OF  
BENZENE IN GROUNDWATER  
MAXIMUM DETECTED VALUE**

DATE: AUGUST 2009

PROJECT NO: 9-915-15716-C

REV. NO.: 1

FIGURE No. 46

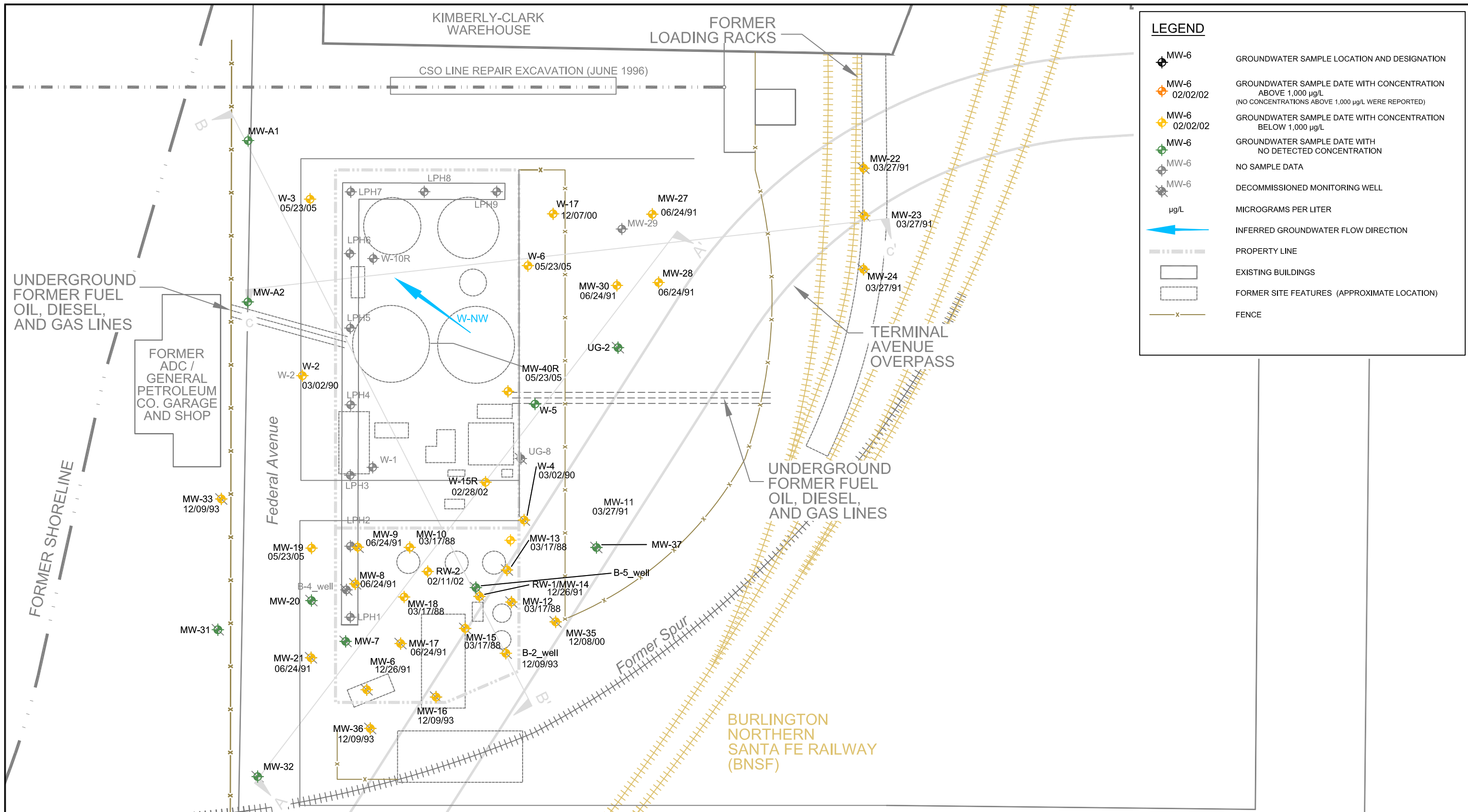

SOURCE: Modified from a map provided by City of Everett, ExxonMobil Oil Corporation and Environmental Resolution, Inc.

SCALE IN FEET

CLIENT LOGO

CLIENT:

**EXXONMOBIL AND AMERICAN DISTRIBUTING COMPANY**

**AMEC Earth & Environmental**  
 11810 North Creek Parkway North  
 Bothell, WA, U.S.A. 98011-8201

DWN BY: JRS / BRJ  
 CHK'D BY: AIS/MS  
 DATUM: NONE  
 PROJECTION: NONE  
 SCALE: 1" = 60'

PROJECT

**EXXONMOBIL/ADC PROPERTY  
 ECOLOGY SITE ID 2728**

TITLE

**HISTORICAL DISTRIBUTION OF  
 TOLUENE IN GROUNDWATER  
 MAXIMUM DETECTED VALUE**

DATE: AUGUST 2009  
 PROJECT NO: 9-915-15716-C  
 REV. NO.: 1  
 FIGURE No. 47

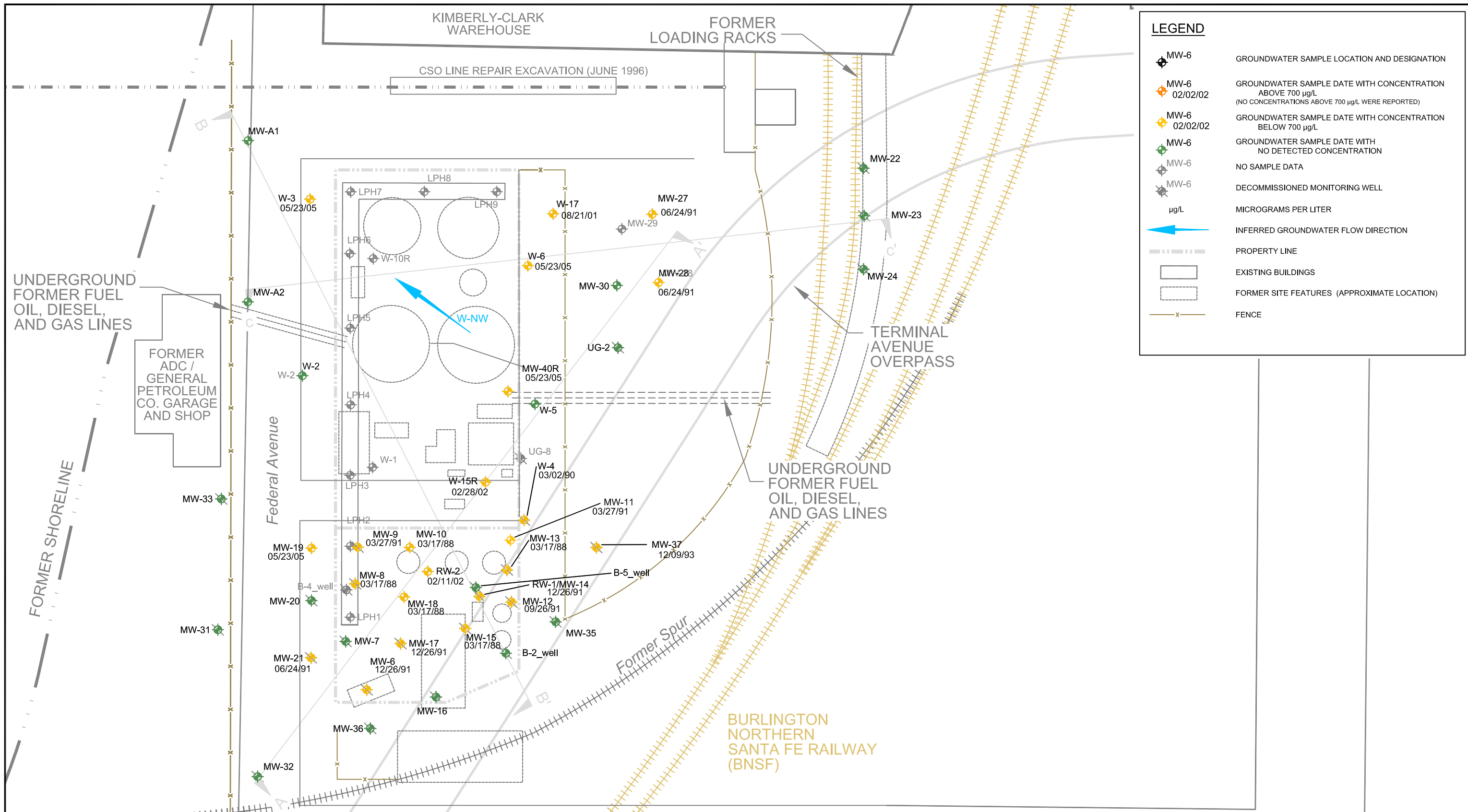

LEGEND	
	GROUNDWATER SAMPLE LOCATION AND DESIGNATION
	GROUNDWATER SAMPLE DATE WITH CONCENTRATION ABOVE 700 µg/L (NO CONCENTRATIONS ABOVE 700 µg/L WERE REPORTED)
	GROUNDWATER SAMPLE DATE WITH CONCENTRATION BELOW 700 µg/L
	GROUNDWATER SAMPLE DATE WITH NO DETECTED CONCENTRATION
	NO SAMPLE DATA
	DECOMMISSIONED MONITORING WELL
	MICROGRAMS PER LITER
	INFERRED GROUNDWATER FLOW DIRECTION
	PROPERTY LINE
	EXISTING BUILDINGS
	FORMER SITE FEATURES (APPROXIMATE LOCATION)
	FENCE

SOURCE: Modified from a map provided by City of Everett, ExxonMobil Oil Corporation and Environmental Resolution, Inc.   SCALE IN FEET	CLIENT LOGO 	CLIENT: <b>EXXONMOBIL AND AMERICAN DISTRIBUTING COMPANY</b>	DWN BY: JRS / BRJ CHK'D BY: AIS/MS DATUM: NONE PROJECTION: NONE SCALE: 1" = 60'	PROJECT <b>EXXONMOBIL/ADC PROPERTY ECOLOGY SITE ID 2728</b>	DATE: AUGUST 2009 PROJECT NO: 9-915-15716-C REV. NO.: 1
		AMEC Earth & Environmental 11810 North Creek Parkway North Bothell, WA, U.S.A. 98011-8201 	TITLE <b>HISTORICAL DISTRIBUTION OF ETHYLBENZENE IN GROUNDWATER MAXIMUM DETECTED VALUE</b>	FIGURE No. <b>48</b>	

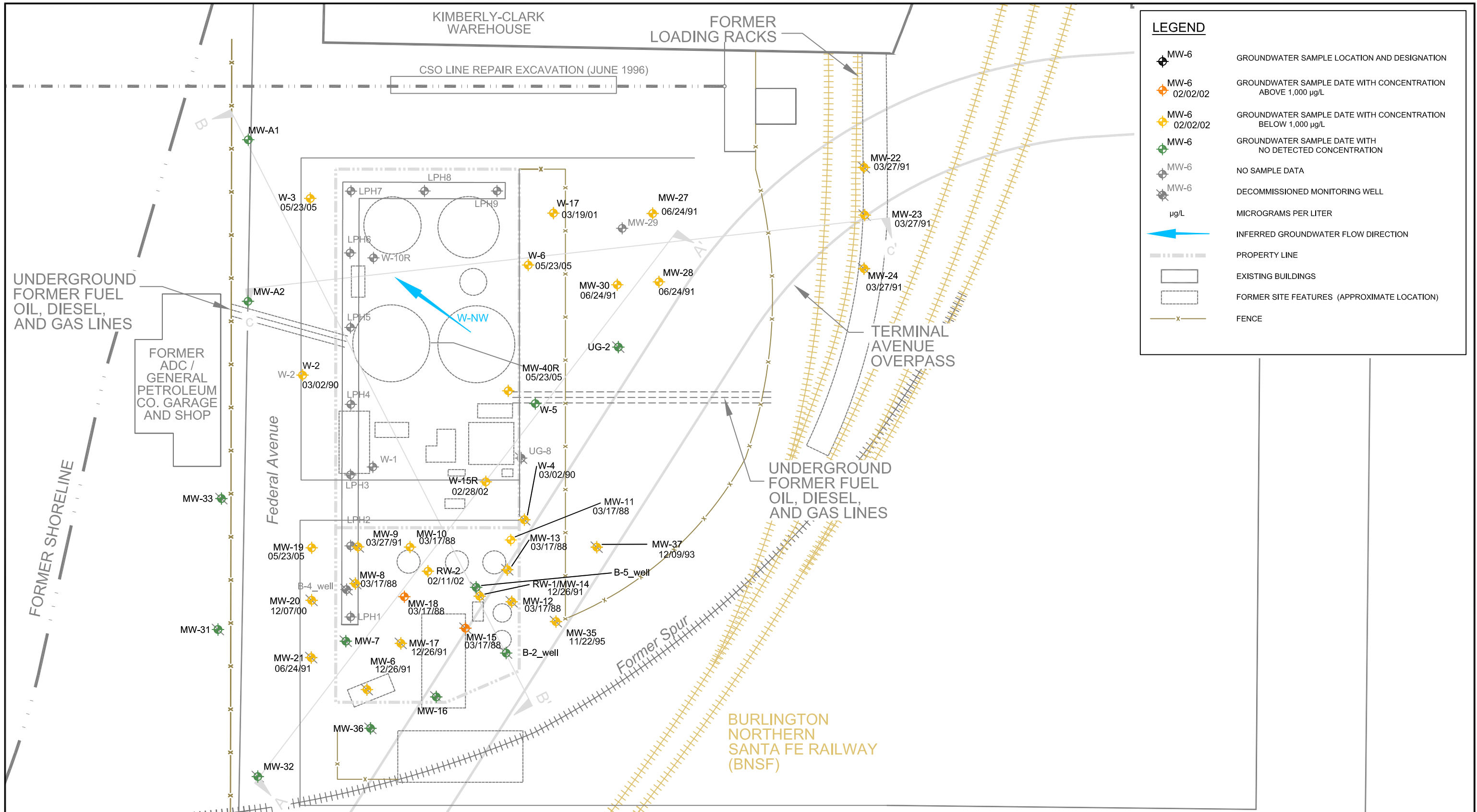

SOURCE: Modified from a map provided by City of Everett, ExxonMobil Oil Corporation and Environmental Resolution, Inc.

0 60 120  
SCALE IN FEET

CLIENT LOGO

CLIENT:

**EXXONMOBIL AND AMERICAN DISTRIBUTING COMPANY**

**AMEC Earth & Environmental**  
11810 North Creek Parkway North  
Bothell, WA, U.S.A. 98011-8201

DWN BY: JRS / BRJ  
CHK'D BY: AIS/MS  
DATUM: NONE  
PROJECTION: NONE  
SCALE: 1" = 60'

PROJECT

**EXXONMOBIL/ADC PROPERTY  
ECOLOGY SITE ID 2728**

TITLE

**HISTORICAL DISTRIBUTION OF  
TOTAL XYLENE IN GROUNDWATER  
MAXIMUM DETECTED VALUE**

DATE: AUGUST 2009  
PROJECT NO: 9-915-15716-C  
REV. NO.: 1  
FIGURE No. 49



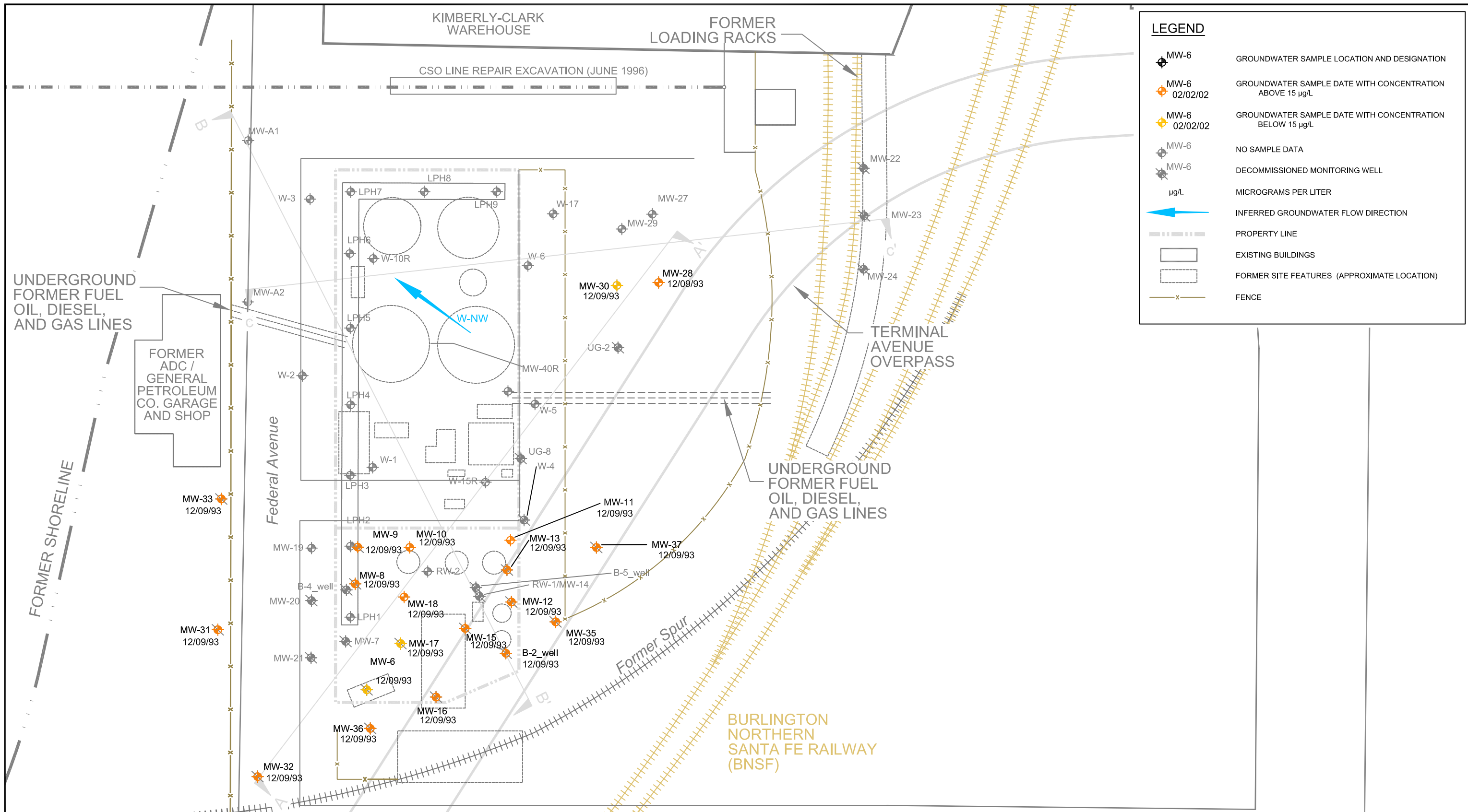

SOURCE: Modified from a map provided by City of Everett, ExxonMobil Oil Corporation and Environmental Resolution, Inc.

CLIENT LOGO

CLIENT:

**EXXONMOBIL AND AMERICAN DISTRIBUTING COMPANY**

**AMEC Earth & Environmental**  
 11810 North Creek Parkway North  
 Bothell, WA, U.S.A. 98011-8201



DWN BY: JRS / BRJ  
 CHK'D BY: AIS/MS  
 DATUM: NONE  
 PROJECTION: NONE  
 SCALE: 1" = 60'

PROJECT: **EXXONMOBIL/ADC PROPERTY ECOLOGY SITE ID 2728**

TITLE: **HISTORICAL DISTRIBUTION OF TOTAL LEAD IN GROUNDWATER MAXIMUM DETECTED VALUE**

DATE: AUGUST 2009  
 PROJECT NO: 9-915-15716-C  
 REV. NO.: 1  
 FIGURE No. 50

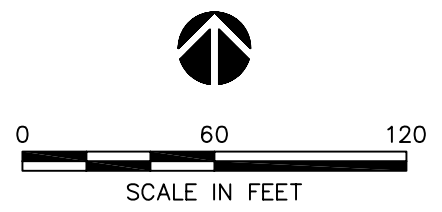

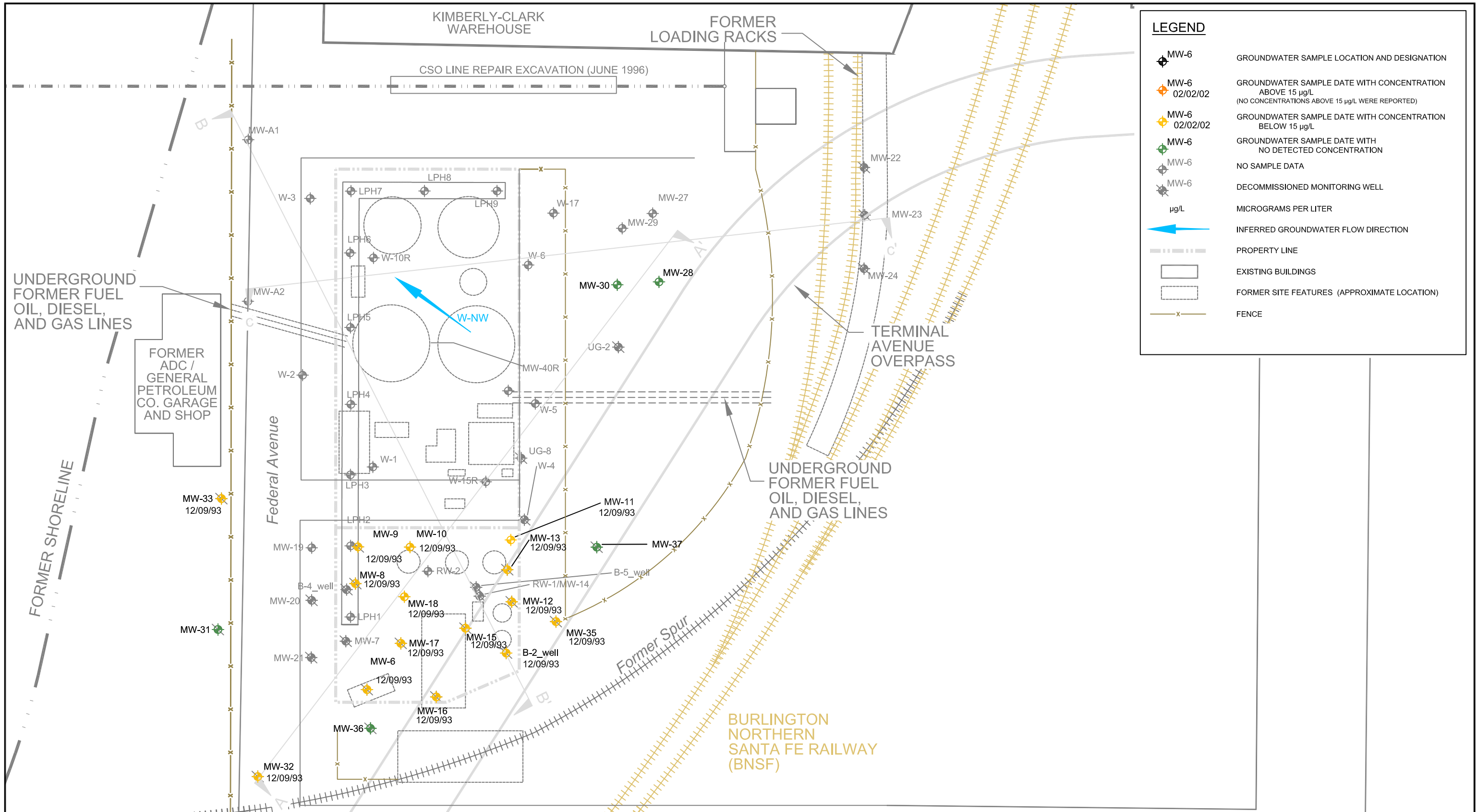

LEGEND	
	GROUNDWATER SAMPLE LOCATION AND DESIGNATION
	GROUNDWATER SAMPLE DATE WITH CONCENTRATION ABOVE 15 µg/L (NO CONCENTRATIONS ABOVE 15 µg/L WERE REPORTED)
	GROUNDWATER SAMPLE DATE WITH CONCENTRATION BELOW 15 µg/L
	GROUNDWATER SAMPLE DATE WITH NO DETECTED CONCENTRATION
	NO SAMPLE DATA
	DECOMMISSIONED MONITORING WELL
	MICROGRAMS PER LITER
	INFERRED GROUNDWATER FLOW DIRECTION
	PROPERTY LINE
	EXISTING BUILDINGS
	FORMER SITE FEATURES (APPROXIMATE LOCATION)
	FENCE

SOURCE: Modified from a map provided by City of Everett, ExxonMobil Oil Corporation and Environmental Resolution, Inc.  0 60 120 SCALE IN FEET	CLIENT LOGO 	CLIENT: <b>EXXONMOBIL AND AMERICAN DISTRIBUTING COMPANY</b>	DWN BY: JRS / BRJ CHK'D BY: AIS/MS DATUM: NONE PROJECTION: NONE SCALE: 1" = 60'	PROJECT <b>EXXONMOBIL/ADC PROPERTY ECOLOGY SITE ID 2728</b>	DATE: AUGUST 2009 PROJECT NO: 9-915-15716-C REV. NO.: 1 FIGURE No. 51
		AMEC Earth & Environmental 11810 North Creek Parkway North Bothell, WA, U.S.A. 98011-8201 	TITLE <b>HISTORICAL DISTRIBUTION OF DISSOLVED LEAD IN GROUNDWATER MAXIMUM DETECTED VALUE</b>		

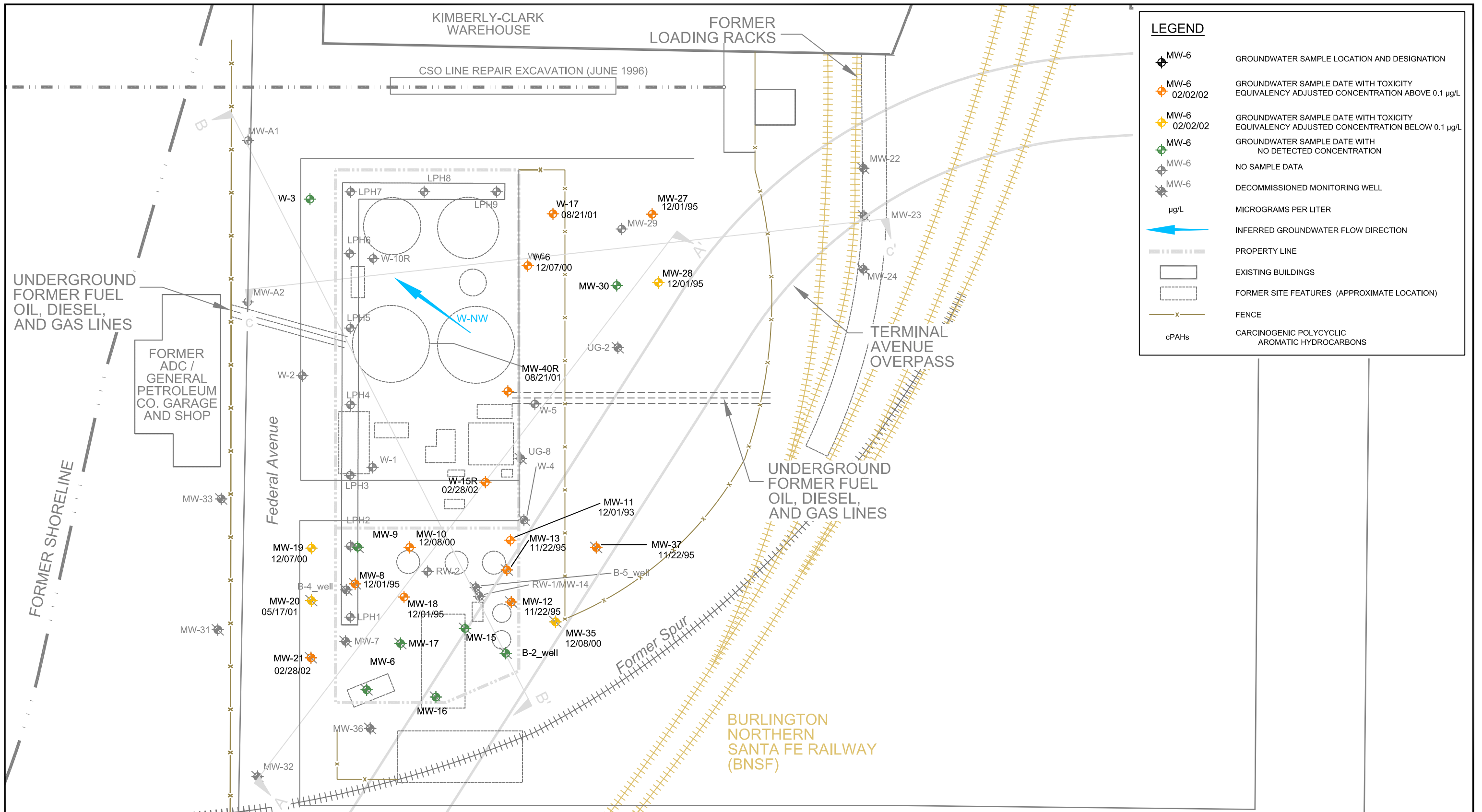

SOURCE: Modified from a map provided by City of Everett, ExxonMobil Oil Corporation and Environmental Resolution, Inc.

SCALE IN FEET

CLIENT LOGO

CLIENT:

**EXXONMOBIL AND AMERICAN DISTRIBUTING COMPANY**

**AMEC Earth & Environmental**  
 11810 North Creek Parkway North  
 Bothell, WA, U.S.A. 98011-8201

DWN BY: JRS / BRJ  
 CHK'D BY: AIS/MS  
 DATUM: NONE  
 PROJECTION: NONE  
 SCALE: 1" = 60'

PROJECT: **EXXONMOBIL/ADC PROPERTY ECOLOGY SITE ID 2728**

TITLE: **HISTORICAL DISTRIBUTION OF TOXICITY EQUIVALENCY ADJUSTED TOTAL cPAHs IN GROUNDWATER, MAXIMUM DETECTED VALUE**

DATE: AUGUST 2009  
 PROJECT NO: 9-915-15716-C  
 REV. NO.: 1  
 FIGURE No. 52

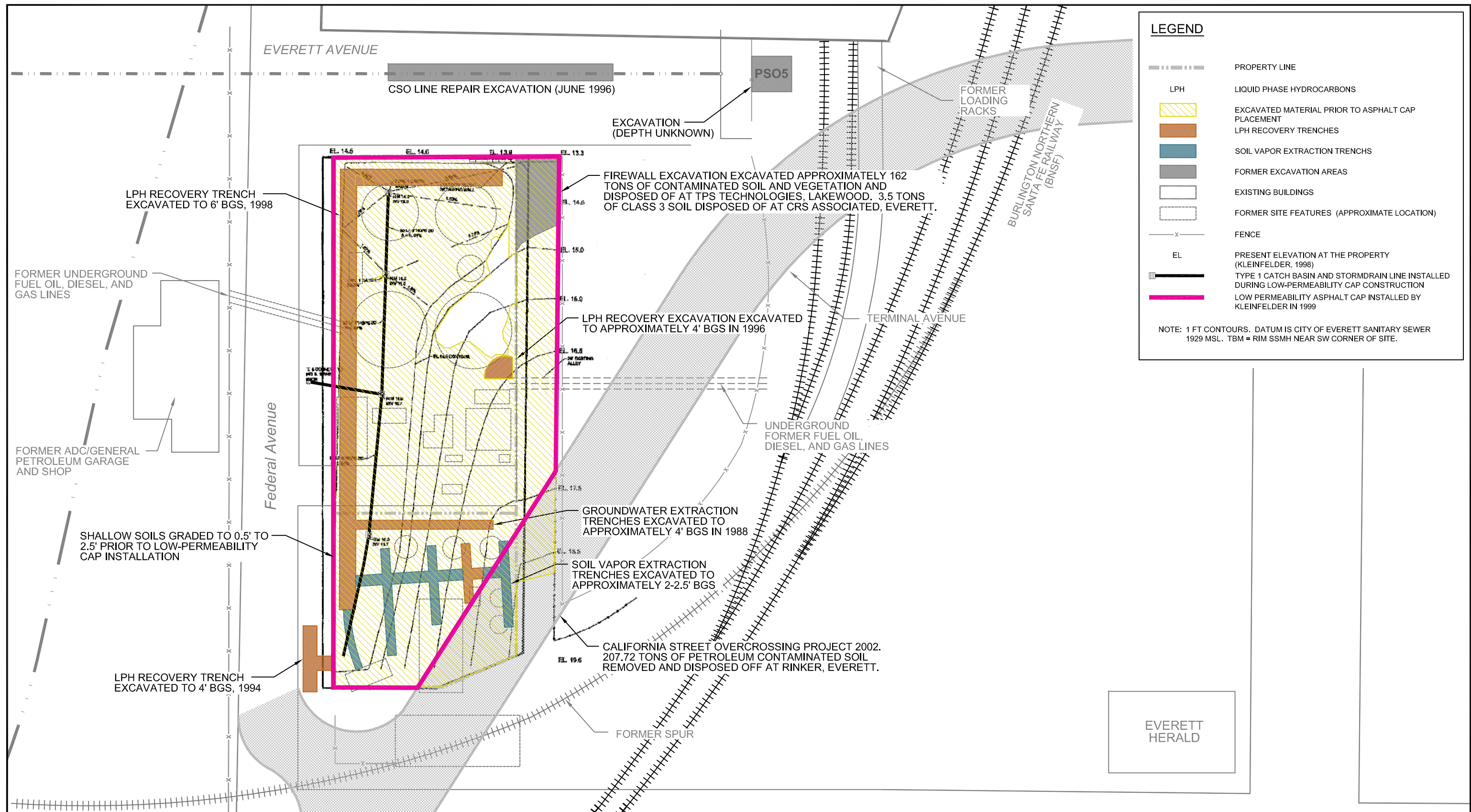

EVERETT  
HERALD

SOURCE: Modified from a map provided by City of Everett, ExxonMobil Oil Corporation and Environmental Resolution, Inc.

CLIENT LOGO

CLIENT:  
**EXXONMOBIL AND  
AMERICAN DISTRIBUTING COMPANY**

DWN BY: JRS / BRJ  
CHK'D BY: AS/MS  
DATUM: NONE  
PROJECTION: NONE  
SCALE: 1" = 60'

PROJECT  
**EXXONMOBIL/ADC PROPERTY  
ECOLOGY SITE ID 2728**

TITLE  
**HISTORICAL EXCAVATION LOCATIONS**

DATE: AUGUST 2009  
PROJECT NO.: 9-915-15716-C  
REV. NO.: 1  
FIGURE No. 53

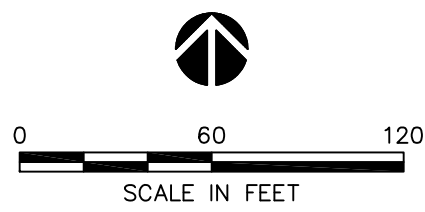

**AMEC Earth & Environmental**  
11810 North Creek Parkway North  
Bothell, WA, U.S.A. 98011-8201



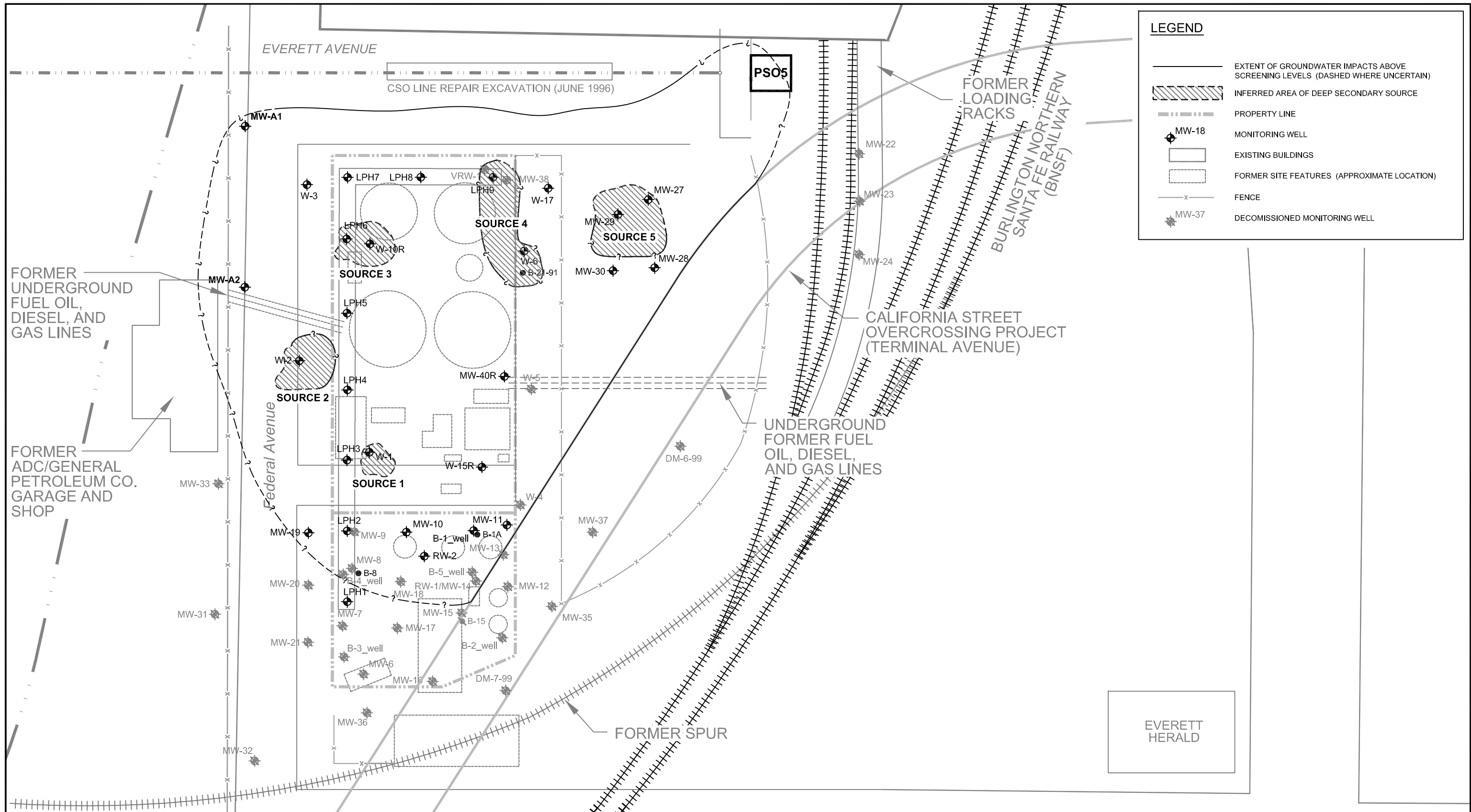

LEGEND	
	EXTENT OF GROUNDWATER IMPACTS ABOVE SCREENING LEVELS (DASHED WHERE UNCERTAIN)
	INFERRED AREA OF DEEP SECONDARY SOURCE
	PROPERTY LINE
	MW-18 MONITORING WELL
	EXISTING BUILDINGS
	FORMER SITE FEATURES (APPROXIMATE LOCATION)
	FENCE
	MW-37 DECOMMISSIONED MONITORING WELL

EVERETT  
HERALD

SOURCE: Modified from a map provided by City of Everett, ExxonMobil Oil Corporation and Environmental Resolution, Inc.

CLIENT LOGO

CLIENT:

**EXXONMOBIL AND  
AMERICAN DISTRIBUTING COMPANY**

**AMEC Earth & Environmental**  
11810 North Creek Parkway North  
Bothell, WA, U.S.A. 98011-8201



DWN BY:  
JRS / BRJ

CHK'D BY:  
AS/MS

DATUM:  
NONE

PROJECTION:  
NONE

SCALE:  
1" = 60'

PROJECT

**EXXONMOBIL/ADC PROPERTY  
ECOLOGY SITE ID 2728**

TITLE

**AREA OF IMPACT  
AND SECONDARY SOURCE AREAS**

DATE:  
AUGUST 2009

PROJECT NO:  
9-915-15716-C

REV. NO.:  
1

FIGURE No.  
54

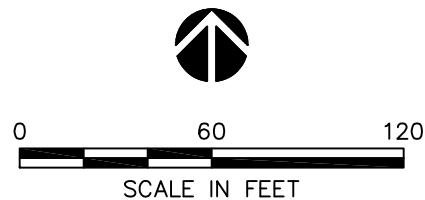

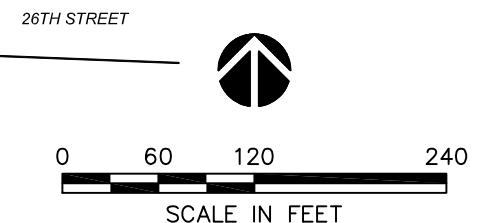

**LEGEND**

MW-A7	PROPOSED MONITORING WELL LOCATION AND NUMBER
AP-6	PROPOSED DEEP BORING LOCATION AND NUMBER
AP-7	PROPOSED PUSH-PROBE BORING LOCATION AND NUMBER
BB-1	PREVIOUS EXPLORATION LOCATION, PLEASE REFER TO FIGURE 3 FOR DETAILS
TP-3	
GP-8	
PROBE-15 KC-2	
AD-5	
LP4	
- - -	PROPERTY LINE
[Solid Line]	EXISTING BUILDINGS
[Dashed Line]	FORMER SITE FEATURES (APPROXIMATE LOCATION)
-x-x-	FENCE

SOURCE: Modified from a map provided by City of Everett, ExxonMobil Oil Corporation and Environmental Resolution, Inc.

CLIENT LOGO

CLIENT:  
**EXXONMOBIL  
AMERICAN DISTRIBUTING CO.**

**AMEC Earth & Environmental**  
11810 North Creek Parkway N  
Bothell, WA, U.S.A. 98011-8201



DWN BY: JRS  
CHK'D BY: AS/MS  
DATUM: NONE  
PROJECTION: NONE  
SCALE: AS SHOWN

PROJECT  
**EXXONMOBIL/ADC PROPERTY  
ECOLOGY ID 2728**

TITLE  
**PROPOSED DATA GAP INVESTIGATIONS  
EXPLORATION PLAN**

DATE:  
FEBRUARY 2010  
PROJECT NO.:  
9-915-15716-C  
REV. NO.:  
FIGURE No.  
55

## **APPENDIX A**

### Sampling and Analysis Plan



**SAMPLING AND ANALYSIS PLAN**  
**ExxonMobil / ADC Property, Ecology Site ID 2728**  
**2717/2731 Federal Avenue**  
**Everett, Washington**

Submitted to:

**ExxonMobil Environmental Services**  
East Providence Terminal  
1001 Wampanoag Trail  
Riverside, Rhode Island 02915

and

**American Distributing Company**  
13618 45th Avenue NE  
Marysville, Washington 98271

Submitted by:

**AMEC Earth & Environmental, Inc.**  
11810 North Creek Parkway North  
Bothell, Washington 98011

February 26, 2010

AMEC Project No. 8-915-15716-C



## TABLE OF CONTENTS

		<u>Page</u>
1.0	<b>INTRODUCTION</b> .....	1
2.0	<b>OBJECTIVES</b> .....	1
3.0	<b>PROJECT ORGANIZATION AND RESPONSIBILITIES</b> .....	2
4.0	<b>DATA QUALITY OBJECTIVES</b> .....	3
5.0	<b>PRE- FIELD ACTIVITIES</b> .....	5
5.1	Field Health and Safety Procedures .....	5
6.0	<b>FIELD PROCEDURES</b> .....	6
6.1	Utility Survey .....	6
6.2	Calibration of Field Equipment .....	6
6.3	Soil Borings .....	7
6.4	Soil Sample Collection .....	7
6.5	Sample Containers, Preservation and Storage .....	8
6.6	Sample Labeling.....	8
6.7	Soil Sample Analyses.....	9
6.8	Soil Geotechnical Analyses.....	9
6.9	Monitoring Well Installation and Development .....	10
6.10	Surveying of Monitoring Wells.....	11
6.11	Groundwater Level Measurements .....	11
6.12	Groundwater Sample Collection.....	11
6.13	Groundwater Sample Analyses.....	12
6.14	Equipment Decontamination .....	13
6.15	Investigation Derived Waste Management.....	13
6.16	Aquifer Testing .....	13
6.17	Tidal Study .....	15
6.18	Historic or Cultural Resources.....	16
7.0	<b>DOCUMENTATION</b> .....	16
7.1	Field Logbook.....	16
7.2	Labeling.....	17
7.3	Sample Chain of Custody.....	17
8.0	<b>QUALITY CONTROL</b> .....	18
8.1	Field Quality Control Samples.....	18
8.2	Laboratory Quality Control Samples.....	19
8.3	Field Variances.....	19
8.4	Data Management.....	19
9.0	<b>REFERENCES</b> .....	19

### **LIST OF TABLES**

Table 1	DQO Objectives
Table 2	Indicator Hazardous Substances
Table 3	Proposed Soil and Groundwater Samples
Table 4	Sample Containers, Preservation and Storage
Table 5	Geotechnical Analyses
Table 6	Natural Attenuation Parameters
Table 7	Tidal Study Well Specifications

### **LIST OF FIGURES**

Figure 1	Site Location Map
Figure 2	Proposed Data Gap Investigation Exploration Plan

### **LIST OF ATTACHMENTS**

Attachment A1	Site-Specific Health and Safety Plan
Attachment A2	Field Documentation Forms

## ACRONYMS AND ABBREVIATIONS

ADC	American Distributing Company
AMEC	AMEC Earth & Environmental, Inc.
bgs	below ground surface
BTEX	benzene, toluene, ethylbenzene, and xylenes
COC	chain-of-custodies
CSS	Colorado silica sand
DAHP	Washington State Department of Archaeology and Historic Preservation
DQIs	data quality indicators
DQOs	data quality objectives
Ecology	Washington State Department of Ecology
EDB	ethylene dibromide
EDC	1,2-dichloroethane
EPA	U.S. Environmental Protection Agency
EPH	extractable petroleum hydrocarbons
ExxonMobil	ExxonMobil Oil Corporation
FFS	Focused Feasibility Study
HASP	Health and Safety Plan
HSA	hollow stem auger
IDW	investigation derived waste
mg/kg	milligram per kilograms
mg/L	milligram/liter
MDLs	method detection limits
MS/MSD	matrix spike/matrix spike duplicate
mV	millivolt
NTUs	nephelometric turbidity units
PAHs	polycyclic aromatic hydrocarbons
PID	photoionization detector
PPE	personal protective equipment
ppm	parts per million
PVC	polyvinyl chloride
Property	ExxonMobil/ADC Property
QA	quality assurance
QC	quality control
RPD	relative percent difference
SAP	Sampling and Analysis Plan
SD	standard deviation
TPH-D	total petroleum hydrocarbons–diesel
TPH-O	total petroleum hydrocarbons–oil
TPH-G	total petroleum hydrocarbons–gasoline
VOCs	volatile organic compounds
VPH	volatile petroleum hydrocarbons
WAC	Washington Administrative Code
WP	Work Plan

## **1.0 INTRODUCTION**

AMEC Earth & Environmental, Inc. (AMEC), has prepared this Sampling and Analysis Plan (SAP) as part of the Focused Feasibility Study (FFS) Work Plan (WP) on behalf of ExxonMobil Oil Corporation (ExxonMobil) and the American Distributing Company (ADC) for the ExxonMobil/ADC Property (the Property) located at 2717 and 2731 Federal Avenue in Everett, Washington (Figure 1). This SAP outlines supplemental field investigations that will be conducted at and near the Property to fill remaining data gaps and obtain the information required to complete the FFS for the Exxon Mobil/ADC Site (Washington State Department of Ecology [Ecology] Ecology Facility ID 2728). This SAP addresses the specific field sampling activities, chemical analyses, and quality assurance (QA) procedures that will be conducted during additional investigations at the Property.

## **2.0 OBJECTIVES**

The objective of the soil and groundwater investigation is to collect additional data needed to define the nature and extent of contamination, support decisions regarding future environmental cleanup, and fill existing data gaps to provide the information necessary to complete the FFS. The soil and groundwater investigation will include the following activities.

1. Install five new groundwater monitoring wells (MW-A3 through MW-A7) to the maximum depth of 15 feet bgs to define the western, northwestern, and northeastern limits of the dissolved-phase plume and to identify potential contamination associated with the former ADC Garage and Shop. Soil samples will be collected from each soil boring for laboratory analysis to ensure that additional petroleum hydrocarbon sources are not contributing to the existing plume (Figure 2).
2. Advance seven deep soil borings around the perimeter of the Property (AB-1 through AB-6) and off-Property to the northeast (MW-A7) to a maximum depth of 35 feet below ground surface (bgs) to determine if a silt layer is present beneath the fill and collect samples for geotechnical analysis. Deep boring MW-A7 will be backfilled to a depth of 13 feet bgs and converted to a shallow monitoring well screened from 3 to 13 feet bgs.
3. Four of the six deep soil borings (AB-1, AB-2, AB-5, and AB-6) will be advanced around the perimeter of the Property to assist in evaluating the lateral extent of the secondary source areas 1, 2, and 4 (Section 7.2 in FFS WP). Soil samples from borings AB-1 and AB-5 will be collected continuously from approximately 0.5 to 5 feet bgs. Shallow samples (above water table) with obvious signs of petroleum-hydrocarbon contamination will be analyzed for TPH-D and TPH-O.

4. Advance seven shallow soil borings (AP-1 through AP-7) to a maximum depth of 15 feet bgs. Six soil borings will be drilled east portion of the Property (near former General Petroleum Corporation's spur fuel loading racks) to define the lateral and vertical extent of soil contamination in the vicinity of MW-29. The seventh boring (AP-1) will be drilled in the area of the former ADC Garage and Shop to determine if any hydrocarbons are present in soils beneath the shop floor. A grab groundwater sample will be collected from AP-1.
5. Perform four quarters of groundwater sampling in all new monitoring wells and in five existing wells for natural attenuation parameters. Groundwater sampling for chemistry parameters will be conducted to be representative of separate wet and dry seasons. During two of the four quarterly sampling events, the groundwater sampling program will include general chemistry water quality parameters (i.e., dissolved oxygen, total organic carbon, alkalinity), in addition to the standard suite of laboratory analytical methods in select monitoring wells.
6. Conduct aquifer testing in two monitoring wells to determine the hydraulic conductivity of off-Property aquifer materials. The aquifer testing will consist of slug tests conducted in newly constructed monitoring wells MW-A5 and MW-A6.
7. Undertake a comprehensive tidal influence study incorporating a temporary stilling well in Puget Sound as well as newly installed and existing groundwater monitoring wells.

### **3.0 PROJECT ORGANIZATION AND RESPONSIBILITIES**

AMEC Earth & Environmental, Inc. (AMEC) is the environmental consultant for this project.

The project is organized as follows:

ExxonMobil and ADC are the owners of the Site.

- Gary Dupuy (phone number 206-342-1777) and Meg Strong (phone number 425-368-0966) are the client managers for the project
- Leah Vigoren (phone number 206-838-8470) is the project manager and is responsible for project management. Technical and administrative elements are included in her project management responsibilities.
- Anastasia Speransky (phone number 206-838-1776) is the task manager for the project and quality assurance manager for this project, which includes data quality objectives, and quality assurance/quality control (QA/QC) objectives.
- Heather Vick (phone number 206-838-8463) is the project hydrogeologist. She is responsible for hydrogeological field activities as well as health and safety.
- Test America, Inc., in Tacoma, Washington, is responsible for managing analyses of the samples collected. The laboratory is also responsible for sample preparation and ensuring that the QA/QC results from the laboratory are valid.

#### 4.0 DATA QUALITY OBJECTIVES

Data Quality Objectives (DQOs) is a quality management tool developed by the U.S. Environmental Protection Agency (EPA) that is used to facilitate the planning of data collection activities. The DQO process provides a systematic procedure for defining criteria in the data collection design. The primary reference for the formal DQO process is EPA's guidance document (EPA 1994). The DQO process consists of the following seven key steps.

1. State the problem.
2. Identify the decision.
3. Identify the inputs to the decision.
4. Define the boundaries of the study.
5. Develop a decision rule.
6. Specify tolerable limits on decision errors.
7. Optimize the design for obtaining data.

DQOs are qualitative and quantitative statements, developed using the DQO process, that are intended to clarify study objectives, define an appropriate type of data, and specify tolerable levels of potential decision errors that will be used as the basis for establishing the quality and quantity of data needed to support decisions.

Table 1 provides the DQOs for the work described in this SAP. Table 2 provides a list of the indicator hazardous substances and their MTCA cleanup criteria.

Data Quality Indicators (DQI) (accuracy, precision, completeness, representativeness, comparability, and method detection limits) refer to quality control criteria established for various aspects of data gathering, sampling, or analysis activity. In defining DQIs specifically for the project, the level of uncertainty associated with each measurement is determined.

**Accuracy** is the degree of agreement of a measurement with a known or true value. To determine accuracy, a laboratory or field value is compared to a known or true concentration. Accuracy is determined by such quality control (QC) indicators as: matrix spikes (MS), surrogate spikes, laboratory control samples (blind spikes) and performance samples. The frequency of analysis of laboratory control samples will be as follows: Method NWTPH-Gx:1 every 20 samples; Method NWTPH-Dx:1 every 10 samples; Method NWTPH-VPH: 1 every 20 samples; Method NWTPH EPH: 1 every 20 samples; Method 8260B: 1 every 12 hours and Method 8270: 1 every 20 samples.

**Precision** is the degree of mutual agreement between or among independent measurements of a similar property (usually reported as a standard deviation [SD] or relative percent difference [RPD]). This indicator relates to the analysis of duplicate laboratory or field samples. An RPD of  $\leq 50\%$  for water and  $\leq 50\%$  for soil, depending upon the chemical being analyzed, is generally

acceptable. Typically field precision is assessed by field duplicates and laboratory precision is assessed using laboratory duplicates, matrix spike duplicates, or laboratory control sample duplicates).

**Completeness** is expressed as percent of valid usable data actually obtained compared to the amount that was expected. Due to a variety of circumstances, sometimes either not all samples scheduled to be collected can be collected or else the data from samples cannot be used (for example, samples lost, bottles broken, instrument failures, laboratory errors, etc.). The minimum percent of completed analyses defined in this section depends on how much information is needed for decision making. Generally, completeness percent goals increase when the fewer the number of samples are collected per event or the more critical the data are for decision making. Goals in the 90 to 95% range are typical.

**Representativeness** is the expression of the degree to which data accurately and precisely represent a characteristic of an environmental condition or a population. It relates both to the area of interest and to the method of taking the individual sample. The idea of representativeness should be incorporated into discussions of sampling design. Representativeness is best assured by a comprehensive statistical sampling design, but it is recognized that this is usually outside the scope of most one-time events. Most one-time event SAP's focus on issues related to judgmental sampling and why certain areas are included or not included and the steps being taken to avoid either false positives or false negatives.

**Comparability** expresses the confidence with which one data set can be compared to another. The use of methods from EPA or "Standard Methods" or from some other recognized sources allows the data to be compared facilitating evaluation of trends or changes in a site, a river, groundwater, etc. Comparability also refers to the reporting of data in comparable units so direct comparisons are simplified (e.g., this avoids comparison of milligram/liter (mg/L) for nitrate reported as nitrogen to mg/L of nitrate reported as nitrate, or parts per million (ppm) vs. mg/L discussions).

**Detection Limit(s)** [usually expressed as method detection limits (MDLs) or Quantitation Limit(s)] for all analytes or compounds of interest for all analyses requested is presented on Table 1. These limits should be related to any decisions that will be made as a result of the data collection effort. A critical element to be addressed is how these limits relate to any regulatory or action levels that may apply.

## Data Review and Management

Data management will commence during the field investigation. Each soil and groundwater sample collected will be recorded in a bound field book which will include a description of the location, depth, matrix, sample ID, and date and time of collection. Once data has returned from the laboratory, the electronic deliverables will be reviewed to ensure the receipt of all requested analytes and again cross-checked with chain-of-custodies (COCs). Data will be tabulated in electronic spreadsheets and again checked to ensure proper entry before use in reporting.

## Assessment Oversight

The project manager will ensure that sample methods and documentation are being practiced. Quality assurance (QA) systems will be emplaced at regular intervals during the data management process as described above. Finally, a peer review process by a senior technical staff will be conducted on the final reporting.

## Corrective Actions

Corrective actions, if necessary, shall be completed. If acceptance criteria were not met and a corrective action was not successful or corrective action was not performed, data will be flagged appropriately. Requirements and procedures for documenting the need for corrective actions are described in this section.

Items requiring corrective action in the laboratory shall be documented by the use of a corrective action report. The QA coordinator or any other laboratory member can initiate the corrective action report request in the event QC results exceed acceptability limits, or upon identification of some other laboratory problem. Corrective actions can include reanalysis of the sample or samples affected, resampling and analysis, or a change in procedures, depending upon the severity of the problem.

## 5.0 PRE- FIELD ACTIVITIES

AMEC will arrange to clear the existing utilities in the project area prior to initiation of field activities. AMEC will contract a private utility locating service in addition to contacting the underground utilities location center (Call Before You Dig). Prior to field activities, AMEC will complete the following activities.

1. Prepare a site-specific Health and Safety Plan (HASP) (Attachment A1).
2. Mark the proposed boring and monitoring well locations.
3. Acquire appropriate permits for drilling and installing monitoring wells.

## 5.1 Field Health and Safety Procedures

Field personnel will adhere to the health and safety procedures detailed in the *Site-Specific Health and Safety Plan*. Potential hazards that may be encountered include heat stress, slips, trips, falls, and exposure to insects.

The hospital closest to the Site is Providence Hospital. An emergency contact list and a map illustrating the emergency route to Providence Hospital is located in the *Health and Safety Plan*.

It is anticipated that all fieldwork will be performed using Level D modified personal protective equipment (PPE), which includes safety glasses, steel-toed boots, and nitrile and/or leather gloves. At a minimum, each on-Site worker will be required to wear safety footwear (steel-toed boots), hard hat, hearing protection, eye protection, and a high visibility safety vest. PPE will be



upgraded whenever there is a potential for direct contact with contaminated soil or groundwater. Changes in the required PPE will be based on changed work conditions and field observations. PPE upgrades may consist of the following:

- Nitrile gloves (surgical-type);
- Tyvek Coveralls – if a splash transfer is considered likely;
- Additional PPE upgrades that may be required, depending on breathing zone levels of petroleum hydrocarbons detected.

Eating, drinking, chewing gum or tobacco, smoking, or any practice that involves hand-to mouth contact increases the probability of contaminant ingestion and is prohibited in any area where the possibility of contamination exists.

Potential physical hazards that may be encountered include heat stress, slips, trips, and falls.

The AMEC field team will have current certifications for first aid, and a cell phone will be available at all times while personnel are in the field. All emergency response services will be reached by calling 911, from a land line if available.

## **6.0 FIELD PROCEDURES**

This section presents the field investigation procedures for the soil and groundwater sampling effort. The field investigation will consist of drilling soil borings, installing monitoring wells, and collecting soil and groundwater samples. The proposed soil boring and monitoring well locations are illustrated on Figure 1. The proposed soil boring locations are listed in Table 3.

### **6.1 Utility Survey**

AMEC will identify all aboveground and overhead power lines. Proposed boring locations that are within 25 feet of an overhead power line will be moved until clearance is achieved. AMEC will also oversee a geophysical survey conducted by a private utility locator to identify subsurface utilities within 25 feet of the proposed soil boring locations. The presence of below-grade utilities will be identified, and their inferred locations will be marked on the ground surface at the site. In addition, subsurface activity locations may be reviewed with the owner or the representative of the owner, if available at the time.

### **6.2 Calibration of Field Equipment**

Field instrument calibration will occur daily at the beginning of field activities. Calibration results and times will be recorded in the field notes. Field equipment requiring calibration includes the photoionization detector (PID) and the Horiba U-22 (or equivalent) water quality meter.

Calibration instructions for the PID and water quality meter are included with the equipment manuals enclosed in the equipment cases. In general, the PID will be used to screen soil for the presence of lighter end petroleum hydrocarbons, such as gasoline and benzene. A Horiba U-22

water quality meter will be used to measure water quality parameters, such as dissolved oxygen, temperature, oxidation-reduction potential, and turbidity. The Horiba U-22 (or equivalent) will be calibrated daily in accordance with the manufacturer's instructions. A record of the daily calibration will be entered in the field log book.

### **6.3 Soil Borings**

Proposed soil borings are listed in Table 3. Seven shallow soil borings (AP-1 through AP-7) will be advanced to a maximum depth of 15 feet bgs using direct-push technology drilling. These borings will be advanced in the vicinity of MW-29 and the former ADC Garage and Shop. Soil samples will be collected continuously from the surface to the total maximum depth of the borings. A soil sample will be collected at the soil/groundwater interface in each soil boring location. An additional sample will be collected based on odor, staining, PID readings, or sheen. If no soil samples exhibit any of these characteristics, the soil sample will be collected from the bottom of the boring to delineate the vertical extent of contamination. A grab groundwater sample will be collected from AP-1 using a temporary screen.

Seven deep soil borings (AB-1 through AB-6 and MW-A7) will be advanced around the western and northern perimeter of the Property to a maximum depth of 35 feet bgs to determine the lithologic conditions underlying that portion of the Site. The borings will be completed at a depth of 35 feet bgs since any proposed slurry wall can be completed as a hanging wall if there is no silt confining layer to key the wall into. The borings will be advanced using a hollow-stem auger (HSA) rig. A soil sample will be collected at the soil/groundwater interface in each soil boring location. An additional sample will be collected based on odor, staining, PID readings, or sheen. If no soil samples exhibit any of these characteristics, the soil sample will be collected from the bottom of the boring to delineate the vertical extent of contamination.

Four soil borings (MW-A3, MW-A4, MW-A5, and MW-A6) will be advanced on the Port of Everett property and will be completed as shallow monitoring wells using a direct-push drill rig equipped with HSA. The wells will be used to determine the western extent of the dissolved plume. A deep soil boring (MW-A7) drilled to a depth of 35 feet will be backfilled to a depth such that MW-A7 will be installed as a shallow monitoring well which straddles the water table (13 feet bgs).

### **6.4 Soil Sample Collection**

Soil samples will be collected from the proposed soil boring and proposed monitoring well locations shown on Figure 1. All soil boring and monitoring well locations are subject to change based on observed conditions in the field (aboveground and belowground utilities, existing equipment, etc.).

Soil samples from the proposed push-probe soil borings/monitoring wells will be collected continuously using a 4-foot stainless steel sampler with a disposable liner.

Soil samples from the five proposed deep soil borings will be collected continuously for lithologic characterization. AMEC will inspect all soil samples and screen the soil samples for volatile organic compounds (VOCs) using a PID.

Each soil sample will be examined and relevant sample information (e.g., depth of sample collection, date and time of sample acquisition, PID measurement, etc.) will be recorded. To prevent cross contamination, any equipment repeatedly in contact with the soil will be decontaminated before and after each individual sampling attempt.

AMEC will select at least two soil samples per soil boring for laboratory analyses. The sample will be selected at the discretion of AMEC on the basis of field observations including a sheen test. A soil sample will be collected for analysis at the soil/groundwater interface in each soil boring location. An additional sample will be collected based on odor, staining, PID readings or sheen. If no soil samples exhibit any of these characteristics, the soil sample will be collected from the bottom of the boring to delineate the vertical extent of contamination.

Samples will be selected from intervals exhibiting petroleum staining and/or elevated PID measurements, the capillary fringe, and/or within an artificial fill unit.

## **6.5 Sample Containers, Preservation and Storage**

Soil and groundwater samples will be collected and placed into precleaned sample containers provided by the analytical laboratory in accordance with Table 4. Upon collection, sample containers will be sealed, labeled, chilled to 4°C in a cooler with ice, and maintained with AMEC's custody until delivery to the project analytical laboratory, Test America, Inc., in Tacoma, Washington.

## **6.6 Sample Labeling**

Each sample container sent to the lab will have a unique sample identification label.

The following information will be included on the sample label:

- Project name and location;
- Project number;
- Sample identification number including sample collection depth;
- Sample depth;
- Date and time of collection;
- Analyses to be performed; and
- Initials of the sampler.

Each soil sample will be assigned a unique alphanumeric code that will be used to identify the source of the sample location. Soil samples will be identified by a label indicating the boring or

monitoring well number followed by a dash followed by the depth (feet) below the ground surface that the sample was collected.

## 6.7 Soil Sample Analyses

Selected soil samples will be submitted to the laboratory for the area-specific chemical analysis. The laboratory analysis will include one or more of the following:

- Total Petroleum Hydrocarbons as Gasoline (TPH-G) by Ecology Method Northwest Total Petroleum Hydrocarbon–Gasoline (NWTPH-G);
- TPH as Diesel and Oil (TPH-D and TPH-O) by Ecology Method NWTPH–Diesel Extended (NWTPH-Dx); TPH-Dx detections with chromatograms that will be run with a silica gel cleanup to remove any biogenic interference (typically from decaying plant matter);
- Benzene, toluene, ethylbenzene, and total xylenes (BTEX) and methyl tertiary butyl ether (MTBE) by U.S. Environmental Protection Agency (EPA) Method 8260B;
- Low-level polycyclic aromatic hydrocarbons (PAHs) by EPA method 8270D SIM;
- 1,2-Dichloroethane (EDC), ethylene dibromide (EDB), and n-hexane in select soil samples that exhibit contamination based on field screening;
- Extractable Petroleum Hydrocarbons (EPH) by Method NW-EPH;
- Volatile Petroleum Hydrocarbons (VPH) by Method NW-VPH.

Soil samples for TPH-G, VOC, and EPH/VPH analyses will be collected using a plastic syringe and placed into laboratory-supplied, preweighed volatile organic analyte vials in accordance with EPA soil sampling method 5035A. Soil samples for all other analyses will be placed in laboratory-supplied glass sample jars and securely fitted with Teflon-lined plastic lids. Particles greater than 2 centimeters in diameter will be removed from the samples and discarded with the drilling cuttings.

EPH and VPH analysis will be requested for soil samples with the highest concentrations of petroleum hydrocarbons and benzene.

Soil sample methods, required sample containers, preservation requirements, and holding times are provided in Table 4.

## 6.8 Soil Geotechnical Analyses

Two soil samples collected from the saturated zone of the perimeter borings will be analyzed for the following: total organic carbon, soil bulk density, porosity, volumetric water content, and permeability (Shelby tube). Samples of drill cuttings will be retained from each boring for use in slurry wall mix design, if necessary. Two 5-gallon buckets of drill cuttings from the 5- to 15-foot depth interval will be collected from each boring location. Shelby tube samples will be collected from fine-grained materials as undisturbed samples. The Shelby tube sampler will be pushed

into undisturbed soil following retrieval of a split-spoon sample that indicates that a fine-grained formation has been encountered. Data from this testing will be used to assist in the development of remedial alternatives. Geotechnical analytical methods are listed in Table 5.

## **6.9 Monitoring Well Installation and Development**

One deep and four shallow monitoring wells (MW-A3, MW-A4, MW-A5, MW-A6, and MW-A7) will be installed using an HSA drill rig and equipment. Soil borings for the monitoring wells will be advanced using 8-inch inside diameter augers. Soil samples to be collected from the monitoring well borings are listed in Table 3. The monitoring wells will be installed in accordance with Washington Administrative Code (WAC) 173-160 Minimum Standards for Construction and Maintenance of Wells.

Each of the monitoring wells will be constructed using 2-inch-diameter, flush-threaded Schedule 40 polyvinyl chloride (PVC) with a 10-foot-long prepack slotted screen with 0.010-inch slots and a 12/20 Colorado silica sand (CSS) pack. A prepack screen is proposed in order to minimize turbidity that has been observed at other monitoring wells in the Site vicinity. The prepack screens also allow rapid construction, since the soil in the area has been observed to heave. The well screens will be installed to straddle the water table. Additional sand (10/20 CSS) will be placed in the annular space surrounding the prepack screens. The sand pack will extend to a height of at least 1 foot above the top of the screen. Placement of the well screen will be determined in the field based on drilling conditions. The wells will be completed with a grout seal to the ground surface. The surface completion will conform to State of Washington standards and will be an 8-inch-diameter, flush-mounted, traffic-rated well monument. Monuments on the Port of Everett property will be constructed of materials that have the same or similar specifications to an eight inch Sherwood monitoring well cover with an 18 inch sonotube concrete surround.

All monitoring wells will be fitted with water-tight locking well caps and locks that are keyed alike.

Following well installation, the monitoring wells will be developed by surging with a surge block, followed by removing water by pumping until the water is clear and free of suspended solids. A minimum of six well volumes will be removed from each newly installed monitoring well. If the well purges dry, well development will resume when the water in the well recharges to 80 percent of the original recorded volume. Well development will cease upon stabilization of temperature, pH, and specific conductivity and turbidity measurements and the removal of six well volumes or two cycles of purging dry, whichever occurs first. AMEC will record the volume of water removed and water quality parameters during well development. An objective of the well development will be to obtain a turbidity value of 5 nephelometric turbidity units (NTU) or as low as is practically possible. The monitoring well development water will be contained in 55-gallon drums and stored at the Property.

## 6.10 Surveying of Monitoring Wells

The horizontal locations and the elevations of the tops of inner and outer casings of the newly installed monitoring wells will be surveyed by a Washington licensed surveyor. Elevations will be established to the nearest 0.01 foot; locations to the nearest 0.1 foot. The monitoring wells will be surveyed to tie into the existing monitoring well network. Both horizontal and vertical controls used for the new well survey will be consistent with horizontal and vertical controls used previously for surveying monitoring wells

## 6.11 Groundwater Level Measurements

Groundwater surface elevations will be used to make an initial assessment of the groundwater potentiometric surface, surface gradient, and direction of groundwater flow. During each groundwater sampling event, two groundwater elevation surveys will be conducted. One survey will be conducted during the high tidal stage, and one survey will be conducted during the low tidal stage.

The groundwater elevation will be measured with a decontaminated electronic water level meter or oil/water interface probe with an accuracy of plus or minus 0.01 feet. The groundwater elevation measurement will be made from a reference point on the top of the PVC well casing (to be surveyed and marked by land surveyors).

The water level probe will be decontaminated between each use, and wells with known or suspected contamination will be measured last.

## 6.12 Groundwater Sample Collection

Groundwater samples will be collected from the newly installed monitoring wells after a minimum of 7 days following development. Existing monitoring wells that do not have a history of containing liquid petroleum hydrocarbons (LPH) will also be sampled. Existing monitoring wells (MW-11, MW 19, MW40R, MW-A1 and MW-A2) and newly installed monitoring wells (MW-A3 through MW-A7) will be sampled using low-flow groundwater sampling techniques (Puls and Barcelona 1996). The groundwater sampling procedure will consist of the following steps.

1. Open well cap and allow well to equilibrate for several minutes.
2. Place an interface probe into the well to determine if LPH is present and measure thickness, if present. The well will not be sampled if LPH is present.
3. Measure depth to water from established top of casing measuring point and record on groundwater sampling field data sheet. Determine the middle depth of the water column that is within the screened interval.
4. Using dedicated (cutter used only for this purpose and kept in a plastic bag) tubing cutter, cut a length of new, low-density polyethylene tubing to extend to the middle depth

of the water column in the well. Connect the end of the tubing to peristaltic pump using dedicated silicone or Masterflex™ tubing.

5. Connect additional tubing to pump discharge line and flow-through cell. Establish flow rate of less than 200 milliliters/minute.
6. Record readings every 3 to 5 minutes with Horiba U-22 or equivalent water quality meter of the following parameters: temperature, pH, specific conductance, dissolved oxygen, oxidation-reduction potential, and turbidity.
7. Also record every 3 to 5 minute measurements of flow rate and depth to water. If drawdown in well exceeds 0.30 feet, reduce flow rate.
8. Stabilization of water quality parameters is assumed when measured parameters are within the following ranges:
  - ± 10 percent pH (standard units)
  - ± 3 percent electrical conductivity (milli-Siemens per centimeter [mS/cm])
  - ± 10 percent oxidation-reduction potential (millivolt [mV])
  - ± 10 percent turbidity (Nephelometric Turbidity Units [NTUs])
  - ± 10 percent dissolved oxygen (milligram per liter [mg/L])
  - ± 10 percent temperature (degrees Centigrade)
9. After stabilization of water quality parameters is achieved, disconnect tubing from flow-through cell and begin sample collection directly from pump discharge tubing.
10. Reduce flow rate to minimal possible flow for collection of volatile organic compound fraction.

### 6.13 Groundwater Sample Analyses

Increased turbidity in groundwater samples is attributed to soil lithological characteristics, increased organic content and/or improper purging and sampling rates during groundwater sample collection. High concentrations of total metals such as lead occurring in groundwater samples is most likely due to increased organic content in the formation being sampled.

Select groundwater samples will be submitted to the laboratory for the area-specific chemical analysis. The laboratory analysis will include one or more of the following:

- TPH using Ecology methods NWTPH-G and NWTPH-Dx;
- BTEX and MTBE by U.S. EPA Method 8260B;
- EDC, EDB, and n-hexane by U.S. EPA 8260B Selected groundwater samples;

- Low-level PAHs by EPA method 8270D SIM;
- Dissolved lead by EPA Method 6020;
- Natural attenuation parameters (see Table 6).

#### **6.14 Equipment Decontamination**

Decontamination of sampling equipment will be performed to maintain data quality, to prevent cross contamination, and to prevent the potential introduction of contaminants into previously unimpacted areas. Reusable sampling equipment, including the drill rig, down-hole drilling equipment, and stainless-steel materials, will be decontaminated prior to each sampling event. General decontamination procedures for nondedicated soil sampling equipment and accessories are as follows.

- Physically remove soils using a nonphosphate detergent solution.
- Rinse with noncontaminated tap water.
- Rinse with deionized water.
- Rinse with Isopropyl alcohol.
- Air dry.

#### **6.15 Investigation Derived Waste Management**

Investigation Derived Waste (IDW) generated during the course of the field investigation will be labeled and securely stored on the Property in 55-gallon drums approved by the U.S. Department of Transportation. Drums will be stored at a designated location. The various waste streams will include the following:

- Potentially contaminated liquids, including fluids derived from purging, development of monitoring wells, and equipment decontamination water; and
- Potentially contaminated solids, principally soil cuttings

Each drum will be labeled with standardized IDW drum labels to indicate its contents, date of collection, location from which the IDW originated, and other pertinent information. In addition, all drums will also be labeled with indelible paint sticks or pens. AMEC will maintain an inventory of the drums. On completion of the project, the IDW will be disposed of at an appropriate off-site facility, following a review of the investigation analytical data.

#### **6.16 Aquifer Testing**

Aquifer testing will be performed to determine the horizontal hydraulic conductivity of water bearing materials at the Site. The hydraulic conductivity (K) is an important hydraulic parameter for estimating groundwater flow rates and other aquifer characteristics. Slug testing will be



performed to estimate K using monitoring wells MW-A5 and MW-A6, which are located west of the site.

A slug test involves the instantaneous injection or withdrawal of a volume or slug of water or solid cylinder of known volume. This is accomplished by displacing a known volume of water from a well and measuring the artificial fluctuation of the groundwater level in the well. Water level changes are usually measured with pressure transducers and recorded by an electronic data logger.

The following equipment will be used to perform the slug test:

- Tape measure (subdivided into tenths of feet)
- Pressure transducer and data logger
- Electronic water level indicator
- Stainless steel or copper slug of known volume
- Dedicated nylon twine for each well to be tested
- Watch or stopwatch with second hand
- Waterproof logbook and pen
- Laptop computer with data logger software preinstalled prior to field event;
- Supplies for decontaminating slug, includingalconox soap, scrub brush, deionized water, and tap water

The following procedure will be used for slug testing each monitoring well.

1. Open the monitoring well and allow several minutes for the well to equilibrate to atmospheric pressure.
2. Measure and record static water level in well. Be sure to allow time for equilibration with atmospheric pressure for wells with unvented caps. If a dedicated bailer or other sampling apparatus in place interferes with initial reading, minimize disturbance as much as possible, and allow time for re-equilibration. Wait and repeat measurement to confirm the well is at steady state.
3. Remove any equipment in the well that would interfere with placing the transducer or conducting the slug test.
4. Measure and record the total depth of the well to verify the well depth and verify that the well screen has not been partly silted in. Sediment in the well screen can affect the slug test results.
5. Place pressure transducer in well to appropriate depth (see depth limits for individual transducers, or manufacturers specifications). Use measuring tape to determine point on

cable to set in well. Do not place transducer so that its range will be exceeded, or so that the transducer cable interferes with movement of the slug.

6. Place slug in well, above the transducer. If desired, a falling head test can be run at this point. It is often found in highly permeable materials, however, that the time required for the slug to fall through the water column may be comparable to the recovery time, and these data may therefore not be usable.
7. When the water level has returned to static height, initialize the data logger.
8. Remove the slug. Use auto-start feature if available, or start data logger by hand.
9. Test may be terminated after recovery is complete, or after 10 to 15 minutes for wells with slow recovery. If possible, screen data in the field to ensure data quality prior to demobilization.
10. Plot data using laptop computer to assure slug test is representative. If data are ambiguous or insufficient, repeat test.

The slug test data will be analyzed using the Bouwer and Rice method (Bouwer 1976, 1989a, 1989b) to obtain estimates of K for each monitoring well tested.

### **6.17 Tidal Study**

A tidal influence study will be conducted to determine if groundwater beneath the Site is affected by tides. Permission will be requested from the Port of Everett to install a temporary stilling well on their dock. The stilling well will be in position for the duration of the Tidal Study at the Site.

Pressure transducers and data loggers will be installed in the four new groundwater monitoring wells on the Port of Everett property (MW-A3, MW-A4, MW-A5, MW-A6) and in existing monitoring wells MW-A1, MW-A2, W-3, MW-11, W-17, W-18 MW-19, MW-28, and MW-40R to record groundwater levels in the zone that is potentially tidally influenced. Specifications of the wells are provided in Table 7. The wells were selected to provide upgradient, on-Site/middle of the site, and downgradient information and are also wells that do not have measured concentrations of free product that would clog the transducers. Monitoring well MW-40R may contain LPH and, if so, will not be used in the tidal influence study.

Elevation measurements will be recorded automatically every 6 minutes for a minimum period of 76 hours. Tidal measurements recorded at the stilling well, located approximately 540 yards to the west of the Site, will be compared to the transducer data.

The data collected from the automatic transducers will be stored in the data logger and downloaded to a computer at the end of the tidal study data collection period. An hour after installation of the in-well transducer, a computer will be linked up to check that it is accurately recording data. On completion, the downloaded data will be corrected for actual groundwater depth and correlated with data from the stilling well. Tidal time lag and tidal efficiencies will be calculated for each monitoring well location. In addition, the tidal study data will be analyzed to determine the mean hydraulic gradient at the site using the method described by Serfes (1991).

The data and the results of the study will be presented in a report to the Washington State Department of Ecology, including maps showing the mean hydraulic gradient at low and high tide and data implications with respect to tidal influence.

### **6.18 Historic or Cultural Resources**

Buried cultural artifacts such as chipped or ground stone, historic refuse, buildings foundations, or human bone could be discovered during subsurface activities, although this is highly unlikely. Initial field activities will include the installation of soil borings and monitoring wells which will result in a minimal amount of site disturbance. As such, a professional archaeologist may not be needed on-site during these activities. Cultural Resource review and the need for any on-site archaeologist will be determined by Ecology in communication with the Department of Archaeology and Historic Preservation (DAHP) and the concerned tribal government.

If any excavations (e.g., test pits) are required for the investigation, a separate cultural resources assessment and work plan will be developed in communication with DAHP and the concerned tribal governments pursuant to RCW 27.44 (Indian graves and records) and 27.53 (Archaeological sites and resources) and a professional archaeologist may required to be on-site to oversee the activities.

If any archaeological resources are discovered during field activities, work will be stopped immediately and Ecology, the DAHP, the City of Everett Planning and Community Development Department, and the Tulalip Tribes Cultural Resources Department will be notified by the close of business. A professional archaeologist will arrange an on-site inspection and invite the parties to attend. The professional archaeologist shall document the discovery and provide a professionally documented site form and report to the above listed parties. In the event of an inadvertent discovery of human remains, work will be immediately halted in the discovery area, the remains will be covered and secured against further disturbance, and the Everett Police Department and Snohomish County Medical Examiner will be immediately contacted, along with DAHP and authorized Tribal representatives. A treatment plan by the professional archaeologist shall be developed in consultation with the above listed parties consistent with RCW 27.44 and RCW 27.53 and implemented according to WAC 25-48.

## **7.0 DOCUMENTATION**

The integrity of data obtained from samples collected during the field investigation depends on proper sample management and handling. Proper sample management includes sample labeling, which includes assignment of a specific identification number and affixing proper identification and markings to the collected samples. Proper handling includes proper packing and transport of the sample containers.

### **7.1 Field Logbook**

The field logbook serves as the primary record of field activities. Entries shall be made chronologically and in sufficient detail to allow the writer or a knowledgeable reviewer to

reconstruct the applicable events. The field logbook shall be bound with consecutively numbered and water repellent pages.

At a minimum, the following information will be recorded in either the field logbook or a separate sample log sheet during the collection of each sample:

- Sample location and description;
- Sampler's name(s);
- Date and time of sample collection;
- Type of sample (soil, groundwater, or surface water);
- Type of sampling equipment used;
- Field instrument readings and calibration; and
- Field observations and details related to analysis or integrity of samples (e.g., weather conditions, noticeable odors, colors, etc.).

## 7.2 Labeling

Each sample container sent to the lab will have a unique sample identification label. The following information will be included on the sample label:

- Project name and location;
- Project number;
- Sample identification number;
- Date and time of collection; and
- Initials of the sampler.

Each soil sample will be named by the location and depth of sample collection in feet. For example, a soil sample collected from soil boring AP-1 at a depth of 2 feet will have a sample designation as "AP1-2." Groundwater samples will be named by the monitoring well location and the date of sample collection. For example, a groundwater sample collected from MW-A2 on March 7, 2010, would be named "XOMADC-02072010-MWA2."

Duplicate samples will be sent to the laboratory blindly. However, the location of the sample will not be revealed to the laboratory. Instead, duplicate samples will be named sequentially as Dup-1 and Dup-2. The location of the duplicate sample collection will be recorded in the field notebook.

## 7.3 Sample Chain of Custody

COC forms will be completed at the end of each sampling day. The completed COC form(s) and samples will be kept in the possession of the field team until relinquishing the samples to the

laboratory or courier service. One copy of the completed COC form will be kept by the field team, and the original COC form will be stored in a resealable plastic bag and transported in the sample container with the laboratory samples. Custody seals will be placed along the seal of each sample container in order to prevent tampering with the samples. A copy of the COC form is included in Attachment A2.

## 8.0 DATA VALIDATION

Data validation is the procedure of reviewing data against a known set of criteria to verify data validity prior to its use. Data validation procedures have been developed by the US EPA to standardize the validation process for analytical results for both water-quality and soil-quality investigations and are documented as the *US EPA Contract Laboratory Program National Functional Guidelines for Superfund Organic Methods Data Review*, US EPA, Office of Solid Waste and Emergency Response, Washington, D.C., Publication 9240.1-48, US EPA-540/R-08-01 (US EPA 2008). The Functional Guidelines are intended to be used as a guide for evaluation of data generated under statements of work for organic and inorganic analyses associated with the US EPA Contract Laboratory Program (CLP). The Functional Guidelines also provide general data validation guidelines that can be applied to data generated by non-CLP analytical methods.

One hundred percent (100%) of the analytical data for soil and groundwater investigation samples will be validated using EPA Stage 4 data validation level. Stage 4 validation includes an examination of sample and QC raw data and instrument printouts to check for technical, calculation, analyte identification, analyte quantitation, and transcription or reduction errors. At a minimum 10% of reported results on summary forms should be confirmed by recalculation. The data validation staff will review field documents and laboratory data report packages, and if needed, apply data qualifiers to the data. The data reviewer will determine if the project data quality objectives have been met, and will calculate the data completeness for the project.

## 9.0 QUALITY CONTROL

This SAP has been prepared to provide instructions and guidance to ensure the sample chemical data collected in support of the site soil and groundwater sampling activities are scientifically valid. Indicator hazardous substances at the Site are listed in Table 2. The sections below outline methods and processes to meet these objectives.

### 9.1 Field Quality Control Samples

To evaluate quality control (QC), two types of QC samples will be collected (trip blank and blind field duplicate). One trip blank will be collected daily and the field duplicate samples will be collected at a frequency of 5 percent of the samples for each matrix (soil and groundwater).

Two trip blank vials provided by the laboratory will be placed into the cooler designated to store samples to be analyzed for VOCs to evaluate the potential for cross-contamination. The trip blanks will be analyzed for TPH using method NWTPH-Gx and for BTEX and MTBE using EPA Method 8260B. Field duplicates are replicate samples collected at the same location during the same sampling session (roughly at the same time). The field duplicate samples will be collected

in the same container types and handled and analyzed in the same manner, as all other soil and groundwater samples. The field duplicates will be analyzed for the same analytes as the primary sample.

## **9.2 Laboratory Quality Control Samples**

Laboratory QC samples are analyzed as part of standard laboratory practice. The laboratory monitors the precision and accuracy of the results of its analytical procedures through analysis of QC samples. In part, laboratory QC samples consist of Matrix Spike/Matrix Spike Duplicate (MS/MSD) samples for organic analyses, and MS/MSD for inorganic analyses. The term "matrix" refers to use of the actual media collected in the field (e.g., routine soil and water samples). Laboratory QC samples are an aliquot (subset) of the field sample. They are not separate samples, but a special designation of an existing sample. The laboratory QC samples will be analyzed for the same analytes as the standard samples.

## **9.3 Field Variances**

As conditions in the field may vary, it may become necessary to implement minor modifications to the sampling as presented in this plan. When appropriate, ExxonMobil, ADC, and Ecology will be notified and a verbal (followed by a written verification) approval will be obtained before implementing the changes. Modifications to the approved plan will be documented in the sampling project report.

## **9.4 Data Management**

Data management will commence during the field investigation. Each soil and groundwater sample collected will be recorded on field logs, which will include a description of the location, depth, matrix, sample ID, and date and time of collection. All data submittals will be consistent with Ecology Policy 840 (dated March 31, 2008) Environmental Information Management (EIM) submittal requirement format. Once data have been provided by the laboratory, the electronic deliverables will be reviewed to ensure the receipt of all requested analytes and again cross-checked with COCs.

## **10.0 REFERENCES**

- Bouwer, H. 1989. The Bouwer and Rice slug test-an update. *Ground Water*, vol. 27, no. 3, pp. 304-309.
- Bouwer, H. 1989a. Discussion of "The Bouwer and Rice slug test- an update. *Ground Water*, vol. 27, no. 5, p. 715.
- Bouwer, H. 1976. A slug test for determining hydraulic conductivity of unconfined aquifers with completely or partially penetrating wells. *Water Resources Research*, vol. 12, no. 3, pp. 423-428.

EPA (U.S. Environmental Protection Agency). 1994. Guidance of the Data Quality Objectives Process. EPA QA/G-4. EPA/600/R-96/055. EPA Office of Research and Development, Washington, D.C. September

Puls, R.W. and Barcelona, M.J. (1996). "Low-Flow (Minimal Drawdown) Groundwater Sampling Procedures," U.S. Environmental Protection Agency, EPA/540/S-95/504.

Serfes, M.E., 1991. "Determining the mean hydraulic gradient of ground water affected by tidal fluctuations", Ground Water, Vol 29, No. 4, pp. 549-555. July-August.

Washington State Department of Ecology (Ecology) (2001). Model Toxics Control Act Cleanup Regulation, Chapter 173-340 WAC. Publication No. 94-06.

Washington State Department of Ecology (Ecology) (2005). Guidance on Remediation of Petroleum-Contaminated Groundwater by Natural Attenuation. Version 1.0. Publication Number 05-09-091. Toxics Cleanup Program. July.

## TABLES



Table 1 Data Quality Objectives

Method	Analyte	MDL	MRL	Units	Surrogate %R	Duplicate RPD	Matrix Spike		Blank Spike		CAS #
							%R	RPD	%R	RPD	
<b>SOIL</b>											
<b>NWTPH-Gx</b>											
NWTPH-Gx	Gasoline Range Hydrocarbons	0.5	5.00	mg/kg dry wt	-	50	10-145	50	80-120	50	8006-61-9
NWTPH-Gx	a,a,a-Trifluorotoluene			Surrogate	50-150	-	-	-	-	-	98-08-8
<b>NWTPH-Dx (w/o Acid/Silica Gel Clean-up)</b>											
NWTPH-Dx	Diesel Range Hydrocarbons	2.00	4.00	mg/kg dry wt	-	48	10-154	48	55-123	48	68476-34-6
NWTPH-Dx	Lube Oil Range Hydrocarbons	2.00	4.00	mg/kg dry wt	-	39	19-146	39	57-128	39	NA
NWTPH-Dx	o-Terphenyl			Surrogate	50-150	-	-	-	-	-	84-15-1
<b>Extractable Petroleum Hydrocarbons</b>											
WA MTCA-EPH	C8-C10 Aliphatics	1.90	5.00	mg/kg dry wt	-	25	50-150	25	50-150	25	NA
WA MTCA-EPH	C10-C12 Aliphatics	1.00	5.00	mg/kg dry wt	-	25	70-130	25	70-130	25	NA
WA MTCA-EPH	C12-C16 Aliphatics	1.40	5.00	mg/kg dry wt	-	25	70-130	25	70-130	25	NA
WA MTCA-EPH	C16-C21 Aliphatics	2.00	5.00	mg/kg dry wt	-	25	70-130	25	70-130	25	NA
WA MTCA-EPH	C21-C34 Aliphatics	3.20	5.00	mg/kg dry wt	-	25	70-130	25	70-130	25	NA
WA MTCA-EPH	C8-C10 Aromatics	2.50	5.00	mg/kg dry wt	-	25	50-150	25	50-150	25	NA
WA MTCA-EPH	C10-C12 Aromatics	0.60	5.00	mg/kg dry wt	-	25	70-130	25	70-130	25	NA
WA MTCA-EPH	C12-C16 Aromatics	1.70	5.00	mg/kg dry wt	-	25	70-130	25	70-130	25	NA
WA MTCA-EPH	C16-C21 Aromatics	3.10	5.00	mg/kg dry wt	-	25	70-130	25	70-130	25	NA
WA MTCA-EPH	C21-C34 Aromatics	4.40	5.00	mg/kg dry wt	-	25	70-130	25	70-130	25	NA
WA MTCA-EPH	C-35			Surrogate	60-140	-	-	-	-	-	94-36-0
WA MTCA-EPH	o-Terphenyl			Surrogate	60-140	-	-	-	-	-	84-15-1
WA MTCA-EPH	2-Fluorobiphenyl			Surrogate	60-140	-	-	-	-	-	321-60-8
WA MTCA-EPH	2-Bromonaphthalene			Surrogate	60-140	-	-	-	-	-	580-13-2
WA MTCA-EPH	1-Chlorooctadecane			Surrogate	60-140	-	-	-	-	-	3386-33-2
<b>Volatile Petroleum Hydrocarbons</b>											
WA MTCA-VPH	C5-C6 Aliphatics	2.00	5.00	mg/kg dry wt	-	25	70-130	25	70-130	25	NA
WA MTCA-VPH	C6-C8 Aliphatics	0.90	5.00	mg/kg dry wt	-	25	70-130	25	70-130	25	NA
WA MTCA-VPH	C8-C10 Aliphatics	2.25	5.00	mg/kg dry wt	-	25	70-130	25	70-130	25	NA
WA MTCA-VPH	C10-C12 Aliphatics	3.65	5.00	mg/kg dry wt	-	25	70-130	25	70-130	25	NA
WA MTCA-VPH	C8-C10 Aromatics	2.40	5.00	mg/kg dry wt	-	25	70-130	25	70-130	25	NA
WA MTCA-VPH	C10-C12 Aromatics	0.30	5.00	mg/kg dry wt	-	25	70-130	25	70-130	25	NA
WA MTCA-VPH	C12-C13 Aromatics	0.50	5.00	mg/kg dry wt	-	25	70-130	25	70-130	25	NA
WA MTCA-VPH	2,5-Dibromotoluene (FID)			Surrogate	70-130	-	-	-	-	-	615-59-8
WA MTCA-VPH	2,5-Dibromotoluene (PID)			Surrogate	70-130	-	-	-	-	-	615-59-8

Table 1 Data Quality Objectives

Method	Analyte	MDL	MRL	Units	Surrogate %R	Duplicate RPD	Matrix Spike		Blank Spike		CAS #
							%R	RPD	%R	RPD	
<b>SOIL (continued)</b>											
<b>Volatile Organic Compounds (Selected List)</b>											
EPA 8260B	Benzene	0.67	2.00	µg/kg dry wt	-	50	42-141	50	78-126	50	71-43-2
EPA 8260B	1,2-Dibromethane (EDB)	0.52	2.00	µg/kg dry wt	-	45	30-155	45	30-155	45	106-93-4
EPA 8260B	1,2-Dichloroethane (EDC)	0.67	2.00	µg/kg dry wt	-	50	32-155	50	70-139	50	107-06-2
EPA 8260B	Ethylbenzene	0.67	2.00	µg/kg dry wt	-	50	21-165	50	79-130	50	100-41-4
EPA 8260B	n-Hexane	0.45	10.000	µg/kg dry wt	-	48	10-180	48	55-136	48	110-54-3
EPA 8260B	Toluene	0.400	2.00	µg/kg dry wt	-	50	45-145	50	76-126	50	108-88-3
EPA 8260B	Total Xylenes	1.30	5.00	µg/kg dry wt	-	50	31-159	50	80-130	50	1330-20-7
<b>Polynuclear Aromatic Hydrocarbons by GC/MS-SIM</b>											
EPA 8270C-SIM	Acenaphthene	0.0003	0.00333	mg/kg dry wt	-	32	42-120	32	44-120	40	83-32-9
EPA 8270C-SIM	Acenaphthylene	0.0004	0.00333	mg/kg dry wt	-	34	39-127	34	46-127	34	208-96-8
EPA 8270C-SIM	Anthracene	0.0007	0.00333	mg/kg dry wt	-	31	39-139	31	49-139	40	120-12-7
EPA 8270C-SIM	Benzo(a)anthracene	0.0003	0.00333	mg/kg dry wt	-	43	31-132	43	53-132	43	56-55-3
EPA 8270C-SIM	Benzo(a)pyrene	0.0004	0.00333	mg/kg dry wt	-	41	22-125	41	57-125	41	50-32-8
EPA 8270C-SIM	Benzo(b)fluoranthene	0.0016	0.00333	mg/kg dry wt	-	50	10-147	50	36-140	50	205-99-2
EPA 8270C-SIM	Benzo(k)fluoranthene	0.0003	0.00333	mg/kg dry wt	-	38	23-140	38	49-140	38	207-08-9
EPA 8270C-SIM	Benzo(ghi)perylene	0.0003	0.00333	mg/kg dry wt	-	50	10-151	50	54-139	50	191-24-2
EPA 8270C-SIM	Chrysene	0.0006	0.00333	mg/kg dry wt	-	40	20-139	40	47-139	40	218-01-9
EPA 8270C-SIM	Dibenz(a,h)anthracene	0.0004	0.00333	mg/kg dry wt	-	50	18-150	50	58-141	50	53-70-3
EPA 8270C-SIM	Fluoranthene	0.0004	0.00333	mg/kg dry wt	-	47	29-135	47	34-135	47	206-44-0
EPA 8270C-SIM	Fluorene	0.0005	0.00333	mg/kg dry wt	-	38	38-129	38	47-129	38	86-73-7
EPA 8270C-SIM	Indeno(1,2,3-cd)pyrene	0.0003	0.00333	mg/kg dry wt	-	46	13-146	46	53-142	46	193-39-5
EPA 8270C-SIM	1-Methylnaphthalene	0.0004	0.00333	mg/kg dry wt	-	35	20-120	35	41-120	35	90-12-0
EPA 8270C-SIM	2-Methylnaphthalene	0.0004	0.00333	mg/kg dry wt	-	38	28-124	38	48-121	38	91-57-6
EPA 8270C-SIM	Naphthalene	0.0007	0.00333	mg/kg dry wt	-	36	10-135	36	42-120	36	91-20-3
EPA 8270C-SIM	Phenanthrene	0.0004	0.00333	mg/kg dry wt	-	46	33-134	46	52-134	46	85-01-8
EPA 8270C-SIM	Pyrene	0.0003	0.00333	mg/kg dry wt	-	50	26-153	50	56-144	50	129-00-0
EPA 8270C-SIM	Nitrobenzene-d5			Surrogate	17-120						4165-60-0
EPA 8270C-SIM	2-Fluorobiphenyl			Surrogate	14-120						321-60-8
EPA 8270C-SIM	p-Terphenyl-d14			Surrogate	18-120	-	-	-	-	-	1718-51-0
<b>GROUNDWATER</b>											
<b>NWTPH-Gx</b>											
NWTPH-Gx	Gasoline Range Hydrocarbons	40.0	100.0	µg/L	-	37	58-139	37	65-129	37	8006-61-9
NWTPH-Gx	a,a,a-Trifluorotoluene			Surrogate	50-150	-	-	-	-	-	98-08-8

Table 1 Data Quality Objectives

Method	Analyte	MDL	MRL	Units	Surrogate %R	Duplicate RPD	Matrix Spike		Blank Spike		CAS #
							%R	RPD	%R	RPD	
<b>GROUNDWATER (continued)</b>											
<b>NWTPH-Dx (w/o Acid/Silica Gel Clean-up)</b>											
NWTPH-Dx	Diesel Range Hydrocarbons	28.0	50.0	mg/L	-	41	10-134	41	50-123	41	68476-34-6
NWTPH-Dx	Lube Oil Range Hydrocarbons	28.0	50.0	mg/L	-	32	18-147	32	49-117	32	NA
NWTPH-Dx	o-Terphenyl			Surrogate	27-150	-	-	-	-	-	84-15-1
<b>Extractable Petroleum Hydrocarbons</b>											
WA MTCA-EPH	C8-C10 Aliphatics	3.0	20.0	µg/L	-	25	50-150	25	50-150	25	NA
WA MTCA-EPH	C10-C12 Aliphatics	2.0	10.0	µg/L	-	25	70-130	25	70-130	25	NA
WA MTCA-EPH	C12-C16 Aliphatics	9.0	30.0	µg/L	-	25	70-130	25	70-130	25	NA
WA MTCA-EPH	C16-C21 Aliphatics	12.0	50.0	µg/L	-	25	70-130	25	70-130	25	NA
WA MTCA-EPH	C21-C34 Aliphatics	19.0	50.0	µg/L	-	25	70-130	25	70-130	25	NA
WA MTCA-EPH	C8-C10 Aromatics	25.0	50.0	µg/L	-	25	50-150	25	50-150	25	NA
WA MTCA-EPH	C10-C12 Aromatics	1.0	10.0	µg/L	-	25	70-130	25	70-130	25	NA
WA MTCA-EPH	C12-C16 Aromatics	3.0	40.0	µg/L	-	25	70-130	25	70-130	25	NA
WA MTCA-EPH	C16-C21 Aromatics	4.0	30.0	µg/L	-	25	70-130	25	70-130	25	NA
WA MTCA-EPH	C21-C34 Aromatics	7.0	50.0	µg/L	-	25	70-130	25	70-130	25	NA
WA MTCA-EPH	C-35			Surrogate	60-140						94-36-0
WA MTCA-EPH	o-Terphenyl			Surrogate	60-140	-	-	-	-	-	84-15-1
WA MTCA-EPH	2-Fluorobiphenyl			Surrogate	60-140						321-60-8
WA MTCA-EPH	2-Bromonaphthalene			Surrogate	60-140						580-13-2
WA MTCA-EPH	1-Chlorooctadecane			Surrogate	60-140	-	-	-	-	-	3386-33-2
<b>Volatile Petroleum Hydrocarbons</b>											
WA MTCA-VPH	C5-C6 Aliphatics	1.0	50.0	µg/L	-	25	70-130	25	70-130	25	NA
WA MTCA-VPH	C6-C8 Aliphatics	1.0	50.0	µg/L	-	25	70-130	25	70-130	25	NA
WA MTCA-VPH	C8-C10 Aliphatics	3.0	50.0	µg/L	-	25	70-130	25	70-130	25	NA
WA MTCA-VPH	C10-C12 Aliphatics	0.90	50.0	µg/L	-	25	70-130	25	70-130	25	NA
WA MTCA-VPH	C8-C10 Aromatics	2.0	50.0	µg/L	-	25	70-130	25	70-130	25	NA
WA MTCA-VPH	C10-C12 Aromatics	0.30	50.0	µg/L	-	25	70-130	25	70-130	25	NA
WA MTCA-VPH	C12-C13 Aromatics	0.30	50.0	µg/L	-	25	70-130	25	70-130	25	NA
WA MTCA-VPH	2,5-Dibromotoluene (FID)			Surrogate	70-130	-	-	-	-	-	615-59-8
WA MTCA-VPH	2,5-Dibromotoluene (PID)			Surrogate	70-130	-	-	-	-	-	615-59-8

Table 1 Data Quality Objectives

Method	Analyte	MDL	MRL	Units	Surrogate %R	Duplicate RPD	Matrix Spike		Blank Spike		CAS #
							%R	RPD	%R	RPD	
<b>GROUNDWATER (continued)</b>											
<b>Volatile Organic Compounds(Selected List)</b>											
EPA 8260B	Benzene	0.410	1.0	µg/L	-	25	70-130	25	70-130	25	71-43-2
EPA 8260B	1,2-Dibromethane (EDB)	0.460	1.0	µg/L	-	10	70-152	10	80-135	10	106-93-4
EPA 8260B	1,2-Dichloroethane (EDC)	0.350	1.0	µg/L	-	25	72-137	25	70-134	25	107-06-2
EPA 8260B	Ethylbenzene	0.350	1.0	µg/L	-	25	70-130	25	70-130	25	100-41-4
EPA 8260B	n-Hexane	0.230	2.0	µg/L	-	13	39-167	13	70-130	13	110-54-3
EPA 8260B	Toluene	0.350	1.0	µg/L	-	25	70-130	25	70-130	25	108-88-3
EPA 8260B	Total Xylenes	0.730	3.0	µg/L	-	25	70-130	25	70-130	25	1330-20-7
<b>Polynuclear Aromatic Compounds by GC/MS with High Volume Injection</b>											
EPA 8270C-HVI	Acenaphthene	0.029	0.100	µg/L	-	35	25-140	35	43-122	35	83-32-9
EPA 8270C-HVI	Acenaphthylene	0.031	0.100	µg/L	-	31	36-135	31	43-129	31	208-96-8
EPA 8270C-HVI	Anthracene	0.076	0.100	µg/L	-	38	20-145	38	50-125	38	120-12-7
EPA 8270C-HVI	Benzo(a)anthracene	0.018	0.100	µg/L	-	50	10-129	50	50-135	50	56-55-3
EPA 8270C-HVI	Benzo(a)pyrene	0.014	0.100	µg/L	-	50	10-136	50	46-136	50	50-32-8
EPA 8270C-HVI	Benzo(b)fluoranthene	0.044	0.100	µg/L	-	50	10-147	50	37-147	50	205-99-2
EPA 8270C-HVI	Benzo(k)fluoranthene	0.027	0.100	µg/L	-	50	10-135	50	47-135	50	207-08-9
EPA 8270C-HVI	Benzo(ghi)perylene	0.018	0.100	µg/L	-	50	10-145	50	30-145	50	191-24-2
EPA 8270C-HVI	Chrysene	0.020	0.100	µg/L	-	50	10-138	50	47-138	50	218-01-9
EPA 8270C-HVI	Dibenz(a,h)anthracene	0.018	0.100	µg/L	-	50	10-144	50	36-144	50	53-70-3
EPA 8270C-HVI	Fluoranthene	0.018	0.100	µg/L	-	40	28-143	40	51-139	40	206-44-0
EPA 8270C-HVI	Fluorene	0.035	0.100	µg/L	-	39	28-144	39	47-128	39	86-73-7
EPA 8270C-HVI	Indeno(1,2,3-cd)pyrene	0.023	0.100	µg/L	-	50	10-142	50	32-142	50	193-39-5
EPA 8270C-HVI	1-Methylnaphthalene	0.030	0.100	µg/L	-	27	37-126	27	37-126	27	90-12-0
EPA 8270C-HVI	2-Methylnaphthalene	0.028	0.100	µg/L	-	29	29-127	29	41-121	29	91-57-6
EPA 8270C-HVI	Naphthalene	0.028	0.100	µg/L	-	32	24-120	32	38-120	32	91-20-3
EPA 8270C-HVI	Pentachlorophenol	0.460	1.00	µg/L	-	32	34-163	32	34-147	32	87-86-5
EPA 8270C-HVI	Phenanthrene	0.051	0.100	µg/L	-	47	31-142	47	45-133	47	85-01-8
EPA 8270C-HVI	Pyrene	0.024	0.100	µg/L	-	37	10-158	37	50-146	37	129-00-0
EPA 8270C-HVI	Nitrobenzene-d5			Surrogate	27-120	-	-	-	-	-	4165-60-0
EPA 8270C-HVI	2-Fluorobiphenyl			Surrogate	29-120	-	-	-	-	-	321-60-8
EPA 8270C-HVI	p-Terphenyl-d14			Surrogate	13-120	-	-	-	-	-	1718-51-0

**Table 1 Data Quality Objectives**

Method	Analyte	MDL	MRL	Units	Surrogate %R	Duplicate RPD	Matrix Spike		Blank Spike		CAS #
							%R	RPD	%R	RPD	
<b>GROUNDWATER (continued)</b>											
<b>Dissolved Metals by EPA 6000/7000 Series Methods</b>											
EPA 6020 - Diss	Lead; dissolved	0.10	2.00	mg/L	-	20	75-125	20	80-120	20	7439-92-1
<b>Natural Attenuation Parameters</b>											
EPA 300.0	Sulfate	0.11	1.00	mg/L	-	20	80-120	20	90-110	20	14808-79-8
EPA 300.0	Nitrate	0.01	0.10	mg/L	-	20	80-120	20	90-110	20	14797-55-8
EPA 6020	Manganese (total; soluble)	0.60	5.00	mg/L	-	20	75-125	20	80-120	20	7439-96-5
RSK-175	Methane	10.0	26.0	µg/L	70-120	33	46-142	33	80-120	33	74-82-8
EPA 310.1	Alkalinity	5.00	10.0	mg/L	-	20	80-120	20	90-110	20	-

Notes:

<sup>1</sup>Titration method; no method detection limit

CAS = chemical Abstracts Service

FID = flame ionization detector

MDL = method detection limit

µg/L = micrograms per liter

µg/kg = microgram per kilograms

mg/kg = milligram per kilograms

mg/L = milligram per liter

MRL = method reporting limit

PID = photoionization detector

%R = percent Recovery

RPD = relative percent difference

VPH = volatile petroleum hydrocarbons

**Table 2 Indicator Hazardous Substances**

Method	Analyte	MDL	MRL	Unit	MTCA Method A		MTCA Method B	
					Unrestricted	Industrial	Carcinogenic	Noncarcinogenic
<b>Petroleum Hydrocarbons by NWTPH-Gx and NWTPH-Dx in Soil</b>								
NWTPH-Gx	Gasoline Range Hydrocarbons	1.40	5.00	mg/kg dry wt	30/100 <sup>1</sup>	30/100 <sup>1</sup>	NR	NR
NWTPH-Dx	Diesel Range Hydrocarbons	2.00	10.0	mg/kg dry wt	2,000	2,000	NR	NR
NWTPH-Dx	Lube Oil Range Hydrocarbons	4.00	25.0	mg/kg dry wt	2,000	2,000	NR	NR
<b>Volatile Organic Compounds per EPA Method 8260B in Soil</b>								
EPA 8260B	Benzene	0.0004	0.0015	µg/kg dry wt	0.03	0.03	18	320
EPA 8260B	Toluene	0.0004	0.0015	µg/kg dry wt	7	7	NR	6,400
EPA 8260B	Ethylbenzene	0.0004	0.004	µg/kg dry wt	6	6	NR	800
EPA 8260B	Total Xylenes	0.0015	0.01	µg/kg dry wt				
EPA 8260B	Methyl tert-butyl ether	0.0006	0.001	µg/kg dry wt				
EPA 8260B	1,2-Dichloroethane (EDC)	0.0006	0.00125	µg/kg dry wt	NoD	NoD	11	1,600
EPA 8260B	1,2-Dibromoethane (EDB)	0.0006	0.005	µg/kg dry wt				
EPA 8260B	n-Hexane	0.0008	0.005	µg/kg dry wt				
<b>Polynuclear Aromatic Hydrocarbons by GC/MS-SIM in Soil</b>								
EPA 8270C-SIM	Acenaphthene	0.00170	0.0100	mg/kg dry wt	NoD	NoD	NR	4,800
EPA 8270C-SIM	Acenaphthylene	0.00170	0.0100	mg/kg dry wt				
EPA 8270C-SIM	Anthracene	0.00170	0.0100	mg/kg dry wt	NoD	NoD	NR	24,000
EPA 8270C-SIM	Benzo(a)anthracene	0.00170	0.0100	mg/kg dry wt	2	0.1	NR	NR
EPA 8270C-SIM	Benzo(a)pyrene	0.00170	0.0100	mg/kg dry wt	2	0.1	0.14	NR
EPA 8270C-SIM	Benzo(b)fluoranthene	0.00170	0.0100	mg/kg dry wt	2	0.1	Tef	NR
EPA 8270C-SIM	Benzo(k)fluoranthene	0.00170	0.0100	mg/kg dry wt	2	0.1	Tef	NR
EPA 8270C-SIM	Benzo(b & k)fluoranthene	0.00330	0.0200	mg/kg dry wt				
EPA 8270C-SIM	Benzo(ghi)perylene	0.00170	0.0100	mg/kg dry wt				
EPA 8270C-SIM	Chrysene	0.00170	0.0100	mg/kg dry wt	2	0.1	Tef	NR
EPA 8270C-SIM	Dibenz(a,h)anthracene	0.00170	0.0100	mg/kg dry wt	2	0.1	Tef	NR
EPA 8270C-SIM	Fluoranthene	0.00170	0.0100	mg/kg dry wt	NoD	NoD	NR	3,200
EPA 8270C-SIM	Fluorene	0.00170	0.0100	mg/kg dry wt				
EPA 8270C-SIM	Indeno(1,2,3-cd)pyrene	0.00170	0.0100	mg/kg dry wt	2	0.1	Tef	NR
EPA 8270C-SIM	1-Methylnaphthalene	0.00170	0.0100	mg/kg dry wt				
EPA 8270C-SIM	2-Methylnaphthalene	0.00170	0.0100	mg/kg dry wt				
EPA 8270C-SIM	Naphthalene	0.00170	0.0100	mg/kg dry wt	5	5	NR	1,600
EPA 8270C-SIM	Pentachlorophenol	0.0023	0.01	mg/kg dry wt				
EPA 8270C-SIM	Phenanthrene	0.00170	0.0100	mg/kg dry wt				
EPA 8270C-SIM	Pyrene	0.00170	0.0100	mg/kg dry wt	NoD	NoD	NR	24,000

**Table 2 Indicator Hazardous Substances**

Method	Analyte	MDL	MRL	Unit	MTCA Method A	MTCA Method B	
					Unrestricted	Carcinogenic	Noncarcinogenic
<b>Petroleum Hydrocarbons by NWTPH-Gx and NWTPH-Dx in Water</b>							
NWTPH-Gx	Gasoline Range Hydrocarbons	38.0	50.0	µg/L	800/1000 <sup>1</sup>	NR	NR
NWTPH-Dx	Diesel Range Hydrocarbons	2.00	10.0	µg/L	500	NR	NR
NWTPH-Dx	Lube Oil Range Hydrocarbons	4.00	25.0	µg/L	500	NR	NR
<b>Volatile Organic Compounds by EPA Method 8260B in Water</b>							
EPA 8260B	Benzene	0.0470	0.200	µg/L	5	0.8	32
EPA 8260B	Toluene	0.0210	0.200	µg/L	1,000	NR	640
EPA 8260B	Ethylbenzene	0.0660	0.200	µg/L	700	NR	800
EPA 8260B	Total Xylenes	0.247	0.750	µg/L	1,000	NR	1,600
EPA 8260B	Methyl tert-butyl ether	0.0930	1.00	µg/L	20	24	6,900
EPA 8260B	1,2-Dichloroethane (EDC)	0.0420	0.200	µg/L	5	0.48	160
EPA 8011	1,2-Dibromoethane (EDB)	0.600	5.00	µg/L	0.01	0.00051	NR
EPA 8260B	n-Hexane	0.129	1.00	µg/L	NoD	NR	480
<b>Polynuclear Aromatic Compounds by GC/MS with High Volume Injection in Water</b>							
EPA 8270C-HVI	Acenaphthene	0.00600	0.100	µg/L	NoD	NR	160
EPA 8270C-HVI	Acenaphthylene	0.00700	0.100	µg/L			
EPA 8270C-HVI	Anthracene	0.00900	0.100	µg/L	NoD	NR	4,800
EPA 8270C-HVI	Benzo(a)anthracene	0.00500	0.0100	µg/L	NoD	Tef	NR
EPA 8270C-HVI	Benzo(a)pyrene	0.00600	0.0100	µg/L	0.1	0.012	NR
EPA 8270C-HVI	Benzo(b)fluoranthene	0.00600	0.0100	µg/L	NoD	Tef	NR
EPA 8270C-HVI	Benzo(k)fluoranthene	0.00600	0.0100	µg/L	NoD	Tef	NR
EPA 8270C-HVI	Benzo(ghi)perylene	0.00700	0.100	µg/L			
EPA 8270C-HVI	Chrysene	0.00600	0.0100	µg/L	NoD	Tef	NR
EPA 8270C-HVI	Dibenz(a,h)anthracene	0.00500	0.0100	µg/L	NoD	Tef	NR
EPA 8270C-HVI	Fluoranthene	0.00900	0.100	µg/L	NoD	NR	640
EPA 8270C-HVI	Fluorene	0.00800	0.100	µg/L	NoD	NR	640
EPA 8270C-HVI	Indeno(1,2,3-cd)pyrene	0.00600	0.0100	µg/L	NoD	Tef	NR
EPA 8270C-HVI	1-Methylnaphthalene	0.00600	0.100	µg/L	NR	NR	NR
EPA 8270C-HVI	2-Methylnaphthalene	0.00800	0.100	µg/L	NR	NR	32
EPA 8270C-HVI	Naphthalene	0.00600	0.100	µg/L	160	NR	160
EPA 8270C-SIM	Pentachlorophenol	0.0068	0.01	µg/L	NoD	0.73	480
EPA 8270C-HVI	Phenanthrene	0.00800	0.100	µg/L	NR	NR	NR
EPA 8270C-HVI	Pyrene	0.00700	0.100	µg/L	NoD	NR	480

**Table 2 Indicator Hazardous Substances**

Method	Analyte	MDL	MRL	Unit	MTCA Method A	MTCA Method B	
					Unrestricted	Carcinogenic	Noncarcinogenic
<b>Dissolved Metals by EPA 6000/7000 Series Methods in Water</b>							
EPA 6020 - Diss	Dissolved Lead	0.000900	0.00100	mg/L	15	NR	NR

Notes:

1. TPH gasoline with benzene present/TPH gasoline without benzene present

MTCA = Model Toxics Control Act

NoD = No data

NR = Not researched

µg/kg = microgram per kilogram

µg/L = microgram per liter

mg/kg = milligram per kilogram

mg/L = milligram per liter

Tef = Toxic equivalency factor



**Table 3 Soil and Groundwater Sampling Locations**

Sample Location	Soil Sample Label	Drilling Method	Maximum Depth (feet)	No. of Soil Samples	Screen Elevation <sup>1</sup>	No. of Groundwater Samples
<b>Soil Borings</b>						
AP-1	AP-1-(depth in feet)	Direct push	15	2	N/A	0
AP-2	AP-2-(depth in feet)	Direct push	15	2	N/A	0
AP-3	AP-3-(depth in feet)	Direct push	15	2	N/A	0
AP-4	AP-4-(depth in feet)	Direct push	15	2	N/A	0
AP-5	AP-5-(depth in feet)	Direct push	15	2	N/A	0
AP-6	AP-6-(depth in feet)	Direct push	15	2	N/A	0
AP-7	AP-7-(depth in feet)	Direct push	15	2	N/A	0
Duplicate soil sample <sup>2</sup>	DUP-S-1			1		
AB-1	AB-1-(depth in feet)	HSA	35	2	N/A	0
AB-2	AB-2-(depth in feet)	HSA	35	2	N/A	0
AB-3	AB-3-(depth in feet)	HSA	35	2	N/A	0
AB-4	AB-4-(depth in feet)	HSA	35	2	N/A	0
AB-5	AB-5-(depth in feet)	HSA	35	2	N/A	0
AB-6	AB-6-(depth in feet)	HSA	35	2	N/A	0
AB-7	AB-7-(depth in feet)	HSA	35	2	N/A	0
MW-A7	MW-A7-(depth in feet)	HSA	35	2	N/A	0
Duplicate soil sample <sup>2</sup>	DUP-S-2			1		
<b>Monitoring Wells</b>						
MW-A3	MW-A3-(depth in feet)	HSA	15	2	0 to 10	4
MW-A4	MW-A4-(depth in feet)	HSA	15	2	0 to 10	4
MW-A5	MW-A5-(depth in feet)	HSA	15	2	0 to 10	4
MW-A6	MW-A6-(depth in feet)	HSA	15	2	0 to 10	4
MW-A7	(3)	HSA	15	(3)	0 to 10	4
Duplicate groundwater sample <sup>4</sup>	DUP-GW-1					4
<b>Total Samples</b>				40		24

Notes:

1. Approximate elevation in feet above mean sea level.
2. Duplicate samples will be collected from intervals exhibiting evidence of potential contamination, such as staining or odor.
3. Soil samples for this boring are listed under soil borings.
4. A duplicate groundwater sample will be collected each quarter.

HSA = hollow-stem auger  
 N/A = not applicable

**Table 4 Sample Containers, Preservation and Storage**

Analysis	Method	Sample Container	Number of Containers	Preservation and Storage	Holding Times
<b>Soil</b>					
Hydrocarbon Identification	NWTPH-HCID	8 oz. CWM jar with PTFE lid	1	4° C	14 days
Gasoline Range Organics	NWTPH-Gx	VOA vial w/MeOH	1	10 mL MeOH	14 days
Diesel Range Organics <sup>1</sup>	NWTPH-Dx	8 oz. CWM jar <sup>2</sup> with PTFE lid	1	4° C	14 days
EPH	MTCA-NW EPH	8 oz. CWM jar <sup>2</sup> with PTFE lid	1	HCl pH<2; 4° C	14 days
VPH	MTCA-NW VPH	8 oz. CWM jar <sup>2</sup> with PTFE lid	1	HCl pH<2; 4° C	14 days
Volatile Organic Compounds <sup>3,4</sup>	EPA 8260B	VOA vial w/stir bar <sup>5</sup>	2	Freeze within 48 hrs	14 days
Polycyclic Aromatic Hydrocarbons	EPA 8270D	8 oz. CWM jar <sup>2</sup> with PTFE lid	1	4° C	14 days
<b>Water</b>					
Gasoline Range Organics	NWTPH-Gx	VOA vial w/MeOH	3	HCl pH<2, 4° C	14 days
Diesel Range Organics	NWTPH-Dx	500-mL amber bottle	2	HCl pH<2, 4° C	14 days
Volatile Organic Compounds <sup>3,4</sup>	EPA 8260B <sup>6</sup>	VOA vial	3	HCl pH<2, 4° C	14 days
Polycyclic Aromatic Hydrocarbons	EPA 8270D	1-Liter Amber	2	None	7 days
Dissolved Lead <sup>7</sup>	EPA 6020	500-mL polyethylene	1	None	180 days <sup>8</sup>

Notes:

1. Silica gel cleanup will be performed on samples where the chromatograph indicates a possible biogenic influence.
2. Sample fraction would come from the same 8 oz jar that was collected for NWTPH-HCID.
3. Includes benzene, toluene, ethylbenzene, total xylenes, and methyl tertiary-butyl ether.
4. Includes 1,2-dichloroethane, 1,2-dibromoethane, and n-hexane for selected samples that appear to be contaminated based on field screening.
5. Sample volume = 5 ounces
6. 1,2-Dibromoethane will be analyzed using EPA Method 8011.
7. Sample to be filtered in the lab.
8. Sample must be filtered within 48 hours of collection for this holding time to apply.

CWM jar = Clear, wide-mouth glass jar

EPH = Extractable petroleum hydrocarbons

HCl = Hydrochloric acid

MeOH = Methanol

PTFE = teflon

VOA = volatile organic analysis

VPH = Volatile petroleum hydrocarbons

**Table 5 Geotechnical Analyses**

<b>Geotechnical Parameter</b>	<b>Analytical Method</b>	<b>Sample Container and Volume</b>	<b>Number of Containers</b>	<b>Preservation and Storage</b>	<b>Holding Time</b>
Fraction organic carbon	Organic content burn	5-gallon bucket	2	None	180 days
Soil bulk density	Unit weight/volume	5-gallon bucket	2	None	180 days
Total soil porosity	(1)	5-gallon bucket	2	None	180 days
Volumetric water content	(2)	5-gallon bucket	2	None	180 days
Permeability		Shelby tube	1	Seal ends and store upright	180 days
Volumetric air content		5-gallon bucket	2	None	180 days

## Notes:

1. Calculated w/ bulk density and particle density.
2. Calculated w/ gravimetric water content.

**Table 6 Natural Attenuation Parameter Sampling Containers, Preservation, and Storage**

Natural Attenuation Parameter Analysis <sup>1</sup>	Method	Sample Container	Number of Containers	Preservation and Storage	Holding Time
Dissolved oxygen (DO)	Field-measured	N/A	N/A	N/A	N/A
Oxidation-reduction potential (ORP)	Field-measured	N/A	N/A	N/A	N/A
pH	Field-measured	N/A	N/A	N/A	N/A
Specific conductance	Field-measured	N/A	N/A	N/A	N/A
Temperature	Field-measured	N/A	N/A	N/A	N/A
Sulfate	EPA 300.0	500 mL unpreserved polyethylene	1	none	28 days
Nitrate	EPA 300.0	500 mL unpreserved polyethylene	1	none	2 days
Ferrous iron (soluble)	Field-measured	N/A	N/A	N/A	N/A
Manganese (soluble)	EPA 6020	500 mL HNO <sub>3</sub> polyethylene	1	HNO <sub>3</sub>	180 days
Methane	RSK175	40 mL HCl Vials	3	HCl	14 days
Alkalinity	EPA 310.1	500 mL unpreserved polyethylene	1	none	14 days

Notes

<sup>1</sup>Ecology, 2005

HCl = hydrochloric acid

HNO<sub>3</sub> = nitric acid

NA = not applicable

VOAs = volatile organic analysis

**Table 7 Tidal Study Well Specifications**

Well No.	Date Installed	Well Depth (feet)	Screened Interval (feet)	TOC Elevation <sup>1</sup>	Depth to Water <sup>2</sup>	Groundwater Elevation <sup>3</sup>	Summary of Lithology
W-3	Feb-90	22.9 <sup>4</sup>	3 to 23	13.27	5.88	7.39	sand; H <sub>2</sub> S odor
W-6	Feb-90	6.5 <sup>4</sup>		14.95	2.83	12.12	sand; organic clay; H <sub>2</sub> S odor
MW-11	Mar-88	18.72 <sup>4</sup>	NS in log	16.28	2.71	13.57	sand (fill); peat
MW-19	Mar-91	5.26 <sup>4</sup>	NS in log	12.79	2.76	10.03	sand
MW-28	June-91	12.18 <sup>4</sup>	2.5 to 11.5	13.86	1.25	12.61	silty sand; peat
MW-40R	No log	12.51 <sup>4</sup>	No log	15.56	3.35	12.21	No log
MW-A1	Feb-08	15.5	5.5 to 15.5	14.07	7.18 <sup>5</sup>	6.89	sand & gravel (fill)
MW-A2	Feb-08	15.5	5.5 to 15.5	12.56	5.82 <sup>5</sup>	6.74	sand & silt (fill)
MW-A3	TBI	TBD	25 to 35 <sup>6</sup>	TBD	TBD	TBD	TBD
MW-A4	TBI	TBD	25 to 35 <sup>6</sup>	TBD	TBD	TBD	TBD
MW-A5	TBI	TBD	25 to 35 <sup>6</sup>	TBD	TBD	TBD	TBD
MW-A6	TBI	TBD	25 to 35 <sup>6</sup>	TBD	TBD	TBD	TBD
MW-A7	TBI	TBD	25 to 35 <sup>6</sup>	TBD	TBD	TBD	TBD

Notes:

1. TOC elevation is in feet above mean sea level.
2. Depth to water in feet below ground surface measured prior to installation of pressure transducer on February 21, 2008.
3. Groundwater elevation is in feet above mean sea level measured prior to installation of pressure transducer on February 21, 2008.
4. Total depth of well measured on February 21, 2008.
5. Depth to water measured on February 24, 2009.
6. Screened interval depth is approximate as wells have not been installed.

H<sub>2</sub>S = hydrogen sulfide  
 NS = Not specified  
 TBI = To be installed  
 TBD = To be determined

## FIGURES

JOB NO.: 9-915-15716-C | DWG DATE: 3-27-2009 10:50am | SCALE: 1"=60' | DESIGN BY: JRS | FILE NAME: 15716-C-01.dwg

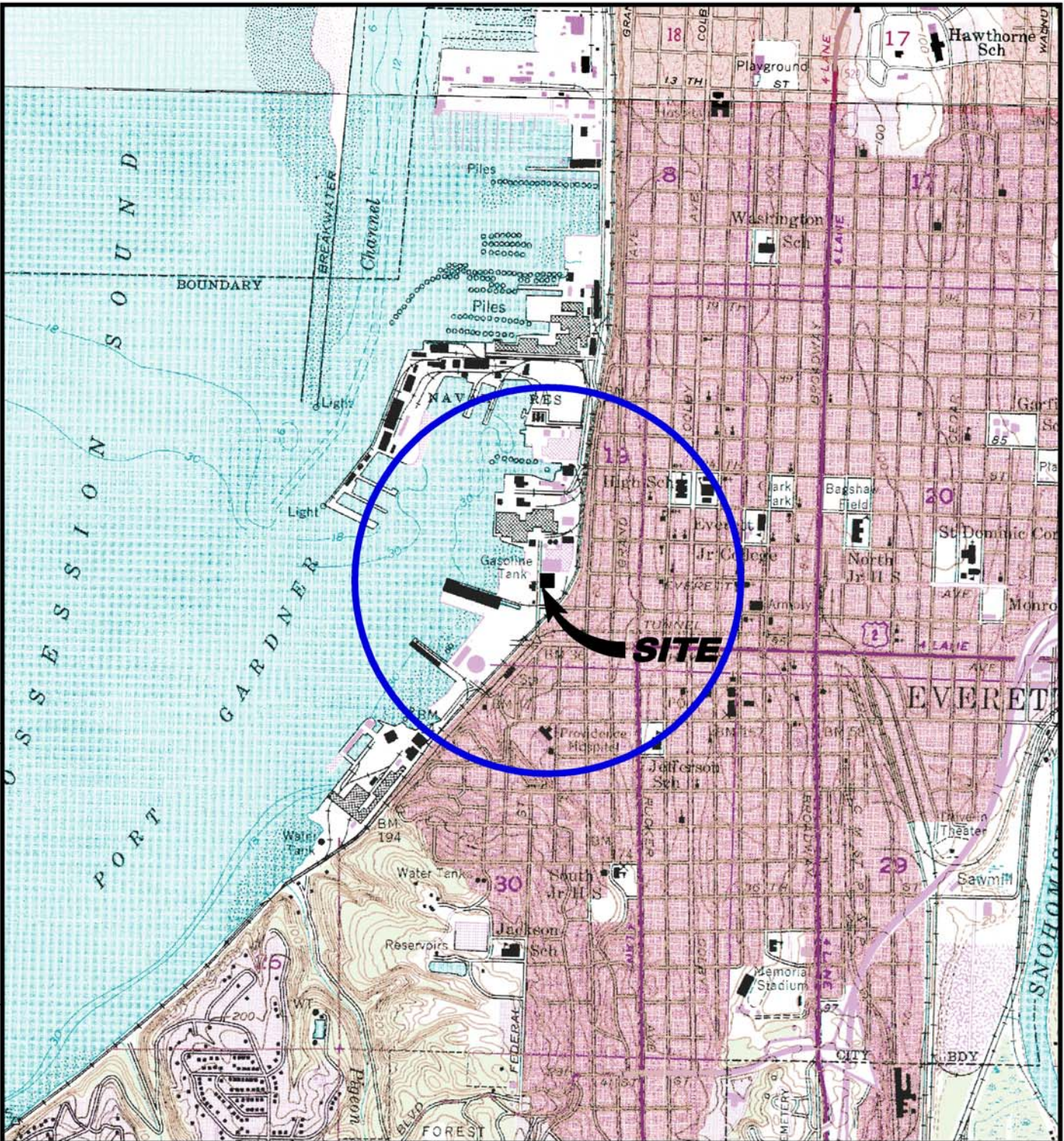

**EXPLANATION**

 1/2-MILE RADIUS CIRCLE

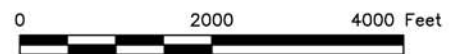

SCALE: 1:24,000

SOURCE: USGS Quad Topo of Everett and Marysville, Photorevised 1973.

**amec**  
 AMEC EARTH & ENVIRONMENTAL, INC.  
 11810 North Creek Parkway North  
 Bothell, WA, U.S.A. 98011-8201

**SITE LOCATION MAP**  
 EXXONMOBIL/ADC PROPERTY, ECOLOGY SITE ID 2728  
 2717/2731 FEDERAL AVENUE  
 EVERETT, WASHINGTON

**FIGURE**  
**1**

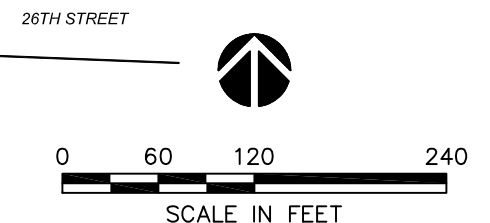

**LEGEND**

MW-A7	PROPOSED MONITORING WELL LOCATION AND NUMBER
AP-6	PROPOSED DEEP BORING LOCATION AND NUMBER
AP-7	PROPOSED PUSH-PROBE BORING LOCATION AND NUMBER
BB-1	PREVIOUS EXPLORATION LOCATION, PLEASE REFER TO FIGURE 3 FOR DETAILS
TP-3	
GP-8	
PROBE-15	
KC-2	
AD-5	
LPH4	
---	PROPERTY LINE
▭	EXISTING BUILDINGS
- - -	FORMER SITE FEATURES (APPROXIMATE LOCATION)
-x-x-	FENCE

SOURCE: Modified from a map provided by City of Everett, ExxonMobil Oil Corporation and Environmental Resolution, Inc.

CLIENT LOGO

CLIENT:  
**EXXONMOBIL  
AMERICAN DISTRIBUTING CO.**

DWN BY: JRS  
CHK'D BY: AS/MS  
DATUM: NONE  
PROJECTION: NONE  
SCALE: AS SHOWN

PROJECT  
**EXXONMOBIL/ADC PROPERTY  
ECOLOGY ID 2728**

DATE:  
FEBRUARY 2010  
PROJECT NO.:  
9-915-15716-C

**AMEC Earth & Environmental**  
11810 North Creek Parkway N  
Bothell, WA, U.S.A. 98011-8201



TITLE  
**PROPOSED DATA GAP INVESTIGATIONS  
EXPLORATION PLAN**

REV. NO.:  
FIGURE No.  
**2**



## **ATTACHMENT A1**

Site-Specific Health and Safety Plan

## **SITE SPECIFIC HEALTH AND SAFETY PLAN**

Project Name: ExxonMobil/ADC Property, Ecology Site ID 2728  
Project Location: 2717/2731 Federal Avenue, Everett, Washington  
Project Number: 9-91-51571-6C

### **THIS SITE SPECIFIC HEALTH AND SAFETY PLAN APPLIES ONLY TO AMEC PERSONNEL.**

**All site personnel must have completed the 8-hour ExxonMobil LPS Training prior to undertaking any field work at the site.**

**A PRE-ENTRY BRIEFING MUST BE HELD PRIOR TO INITIATING ANY SITE ACTIVITY AND AT OTHER TIMES AS NECESSARY TO ENSURE EMPLOYEES ARE APPRISED OF THE SITE HEALTH AND SAFETY PLAN.**

### **SAFETY PERSONNEL:**

Health and Safety Coordinators:	Leah Vigoren and Anastasia Speransky
Project Engineers:	Leah Vigoren and Stephen Dailey
Project Managers:	Meg Strong and Gary Dupuy
Site Safety Coordinator (SSC):	Leah Vigoren
Client Contact:	Joe Abel: ExxonMobil Environmental Services (EMES)

### **EMERGENCY CONTACTS:**

Hospital / Emergency Room:	<b>Providence Medical Center</b>	<b>425-258-7555</b>
----------------------------	----------------------------------	---------------------

**Map showing shortest route to Hospital is attached to this document.**

Fire:	911
Police:	911
Poison Control Center:	1-800-222-1222
Emergency Water Shut-off: Everett	1-425-257-8821
Electric Utility: Snohomish County PUD	1-877-783-1000
Washington State Patrol:	911

Health and Safety Coordinator: Leah Vigoren (Cell Phone: 206-351-9449)	206-342-1760 (w)
Project Manager: Meg Strong (Cell Phone: 425-864-2096)	425-368-0966 (w)

AMEC Earth & Environmental, Inc.  
11810North Creek Parkway  
Bothell, Washington  
USA 98011  
(425) 368-1000 Phone  
(425) 368-1001 Facsimile

## **SITE HISTORY**

The approximate 1-acre site was purchased by ExxonMobil's historic predecessors in 1922, and was utilized as a petroleum bulk storage distribution facility between 1922 and 1974. In 1974, the then Mobile Company sold two thirds of the site (northern portion) to A.P. Miller (Miller), for use by the American Distributing Company (ADC). In 1987, Mobile discontinued petroleum storage and dispensing operations on their portion of the site and removed all storage tanks and ancillary equipment. In 1990, petroleum distribution was discontinued on the ADC parcel, and some improvements and tanks were removed from the parcel. Since then, the site has been turned into a parking lot and is leased to the Kimberly Clark facility located to the north of the site. Activities that have occurred on the site since this time have been environmental investigations and remedial activities to address petroleum impacts to soil and groundwater.

In 1985, site characterization activities were initiated to define the nature and extent of petroleum impacts beneath the site. Between 1988 and 1996, a variety of Interim Remedial Action Measures (IRAMs) were implemented to address the free product. In 1998, a Remedial Investigation/Focused Feasibility Study (RI/FFS) was performed in coordination of the Washington State Department of Ecology (Ecology) under the Consent Order. Remedial Action Objectives (RAOs) were developed for the site based on the RI data and baseline human health risk assessment. The remedy selected to achieve RAOs included the following.

- 1) Construction of an interceptor trench along the down gradient margins of the site (entire western and northern boundaries) to mitigate the off-site migration of the light non-aqueous phase liquid (LNAPL) present on the shallow water table.
- 2) Placement of low-permeability cap across the entire site surface
- 3) Ongoing removal and disposal of recovered LNAPL from site monitoring wells and interceptor trench; and
- 4) Quarterly groundwater monitoring.

## **ORGANIZATIONAL STRUCTURE**

### **Project Manager(s):**

Gary Dupuy (phone number 206-342-1777) and Meg Strong (phone number 425-368-0966) are the client managers for the project. Responsibilities include remaining in contact with regulatory agencies such as the Department of Ecology, overseeing the Project and ensuring client satisfaction from commencement to closeout.

### **Site Safety and Health Supervisor:**

Leah Vigoren (phone number 206-838-8470) and Anastasia Speransky (phone number 206-838-1776) are the acting Health and Safety Coordinators (HSCs). Primarily the duties of the HSC entail coordination with the Project manager for preparation of site health and safety plans, assessment of chemical hazards and selection of safety / monitoring equipment.

The HSC will also take on the duties of the Site Safety Coordinator. The SSC has the responsibility of implementing the Site Health and Safety Plan while at the Site. The SSC / HSC will be involved with the Project Manager in preparation of the Site Health and Safety Plan. If the plan is not being implemented or if unanticipated situations arise, the SSC / HSC may stop all proceedings and see that all personnel depart the site. The SSC / HSC will have charge of all instruments and see to their proper use and function.

**Project Engineer:**

Stephen Dailey (phone number 206-342-1775) is the project engineer and is responsible for developing the site conceptual model and providing engineering input to the FFS.

**Field Technicians:**

Joseph C. Petrick, and Danah Palik are the Field Technicians whose responsibilities include obtaining groundwater samples and other data, as required, from monitoring wells. Keeping field records (I.e. Daily Field Logs) describing field activities, observations and site events. Supplying daily reports and reporting all incidents to the Project Engineer.

**Subcontractor**

Transport and disposal company (Clear Harbors: AWSL Subcontractor) is responsible for removing all waste from the jobsite and transferring it to a certified facility for disposal.

Drilling company "Cascade Drilling, Inc." is responsible for the advancement of soil borings and the installation of monitoring wells on the site.

**ON SITE TASKS**

AMEC to remove light non-aqueous phase liquid (LNAPL) monthly and continue the quarterly groundwater monitoring program at the site. Groundwater samples will be collected and analyzed for diesel and heavy oil range organics using Method Northwest Total Petroleum Hydrocarbons Diesel Extended (NWTPH: NWTPH-D, which includes NWTPH-oil (O) with Silica Gel clean-up), gasoline range organic compounds using Method NWTPH-gasoline Extended (Gx), and benzene, toluene, ethyl benzene, and total xylenes (BTEX) using U.S. Environmental Protection Agency (EPA) Method 8260B.

During monthly O&M events LNAPL is collected by AMEC personnel and stored in two 55-gallon drums within a secured shed on the project site. To mitigate spill hazards, and possible drum failure, these drums are placed on a secondary containment platform which would collect any spilled free liquids. When the drums are full a certified waste transporter and disposal company (ASWL Subcontractor) is contacted to transport the drums for disposal.

AMEC will oversee the advancement of 18 soil borings and the installation of 5 new monitoring wells on the site. Cascade Drilling of Woodinville Washington will conduct the drilling on the site and provide all equipment and personnel necessary. This work will require utility clearances prior to the initiation of drilling. Drilling involves the use of heavy equipment which will require safety precautions during set up and operation. Drilling and sampling at the site brings potentially-contaminated subsurface materials to the surface where Cascade drilling personnel or AMEC personnel overseeing the drilling may be exposed. Soil samples will be collected from each soil boring; a total of 2 samples per boring will be submitted for analyses including NWTPH-Dx, NWTPH-Gx, and BTEX by 8260B. After monitoring well installation, the 5 new wells will be sampled as part of AMEC's ongoing quarterly groundwater monitoring program at the site.

AMEC will be conducting a tidal influence study in which a stilling well will need to be installed on a portion of the Everett pier. The stilling well will need to extend into the water such that the lower portion of it is always submerged. The tidal influence study will consist of programming and installing pressure transducers and data loggers in approximately 12 monitoring wells which will measure water level fluctuations which will be analyzed for the presence and extent of tidal influence.

## SAFETY & HEALTH HAZARDS ANALYSIS

---

### a) Physical Hazards

Physical hazards that may be encountered during site activities include noise, manual lifting, powerful moving parts and weather related hazards (cold, heat stress, wind). Hard hats, safety glasses, hearing protection and steel-toed boots will be required for all personnel working in the vicinity of heavy equipment.

Identified hazards may be mitigated by using safe work practices at all times. The SSC has total responsibility for ensuring that all AMEC personnel on-site perform work tasks in a safe and sensible manner. If at any time the SSC determines that safe work practices are not followed, the tasks will be suspended and corrective actions will be taken.

Because of the potential of explosion hazard presented during groundwater monitoring (i.e., W-2) **SMOKING WILL NOT BE ALLOWED WITHIN 50 FEET OF THE WORK ZONE.**

The following are all additional site related hazards:

- 1) **Traffic**
  - a. Cones will be set out around the work area and safety reflective vests will be worn.
- 2) **Personnel or property damage from vehicle movement.**
  - a. When moving vehicles the following precautions must be taken
  - b. Equipment must be stowed and secured
  - c. A spotter must be used due to the presence of blind spots in the driver's field of vision.
  - d. The spotter must identify any surface obstruction / anomalies
  - e. Audible warning signals and hand signals must be used.
  - f. Operator must yield to pedestrians.
- 3) **Personal injury from handling heavy objects.**
  - a. Use proper lifting techniques; keeping back straight and lift with arms and legs; keep load near body; avoid reaching.
  - b. Do not attempting to lift anything that weighs more than 60 pounds.
  - c. Use mechanical equipment such as a cart to carry / lift large, heavy or awkward loads.
- 4) **Slips, trips and falls.**
  - a. Scan area prior to start of work.
  - b. Group all equipment and waste in one designated area.
  - c. Return tools not in use to storage.
- 5) **Pinch points on drum and well covers.**
  - a. Personnel will wear leather gloves when working with well and drum covers.
- 6) **Broken Glassware**
  - a. Personnel will use bubble wrap and blue ice when transporting samples in glass containers.
  - b. Personnel will not overtighten caps on glass bottles.

### b) Chemical Hazards

Chemical hazards that could possibly be encountered include Gasoline, BTEX, hydrogen sulfide (H<sub>2</sub>S), and methane (CH<sub>4</sub>). The Permissible Exposure Limit (PEL) for Gasoline, BTEX, and hydrogen sulfide, and the Threshold Limit Value (TLV) for methane are listed in the attached table. The nature of this project precludes continuous exposure to any potential contaminant.

**Per past anecdotal evidence, monitoring well (MW) 30 occasionally has contained small amounts of hydrogen sulfide gas. In addition, during installation, well (W) 2 contained methane gas exceeding the lower explosive limit (LEL). AMEC will conduct initial air monitoring using a multi-gas combustible gas**

indicator (CGI) upon opening wells for sampling. Ensure that the atmosphere is less than 10% LEL, contains between 19.5% and 23.5% oxygen, less than 10 parts per million (ppm) H<sub>2</sub>S and less than 10 ppm carbon monoxide prior to proceeding with sampling. Each well will be continuously monitored during sampling. The CGI will alarm if atmospheric concentrations exceed the levels required for entry. (Subsequent air monitoring for the year following installation indicates that no hazardous amounts of CH<sub>4</sub> have been detected in or nearby W2 since installation.

- 1) **Personal Injury from chemical contact / exposure / inhalation.**
  - a. Inspect drums before handling to ensure they are not leaking or bulging, or show any signs of loss of integrity.
  - b. AMEC personnel will place themselves upwind when opening monitoring wells.
- 2) **Personal injury from vapor ignition.**
  - a. AMEC personnel will use metal buckets when collecting and moving product.

#### c) Biological Hazards

The project site is a flat graded parking lot which eliminates most biological hazards. Current biological hazards are limited to the possibility of insects and / or rodents residing within the monitoring wells. AMEC personnel will take caution when opening the wells and will be wearing leather gloves to mitigate this hazard.

## TRAINING

All AMEC personnel will review the site specific Health and Safety plan before accessing the site. Personnel onsite will also have current 40-Hour Hazardous Waste Operations and Emergency Response (HAZWOPER) Certification.

Certificates of HAZWOPER completion will be maintained at the Kirkland office and will be available to regulatory personnel upon request. All Personnel shall carry current 40-hour HAZWOPER training cards or appropriate paperwork while working onsite. The SSC / HSC shall be first aid and CPR trained.

In addition all site personnel must have completed the **8 hour ExxonMobil LPS Training** prior to undertaking any field work.

## PERSONAL PROTECTIVE EQUIPMENT (PPE)

AMEC will wear Level D PPE which consists of steel-toed, chemical resistant rubber boots, inner glove of PVC or latex, outer gloves of Nitrile or equivalent, safety glasses, Tyvek coveralls, and a hard hat. During construction activities, minimal PPE hearing protection will consist of soft foam ear-bud style plugs.

## MEDICAL SURVEILLANCE

---

Evidence of a current physical examination in the form of a letter from an examining physician will be maintained at the Bothell office and will be available to regulatory personnel upon request.

### Air Monitoring

AMEC will conduct initial air monitoring using a photoionization detector (PID) upon opening wells for sampling. PID utilizes ultraviolet light to ionize gas molecules and is commonly employed in the detection of volatile organic compounds (VOCs). AMEC will ensure that the concentrations of VOCs are less than 5 parts per million (ppm) in breathing zone prior to proceeding with sampling. Each well will be continuously monitored during sampling. The

PID will alarm if VOC concentrations exceed the levels required for breathing. AMEC will calibrate the PID both pre and post site visits using Isobutylene calibration gas with compatible regulator.

Air monitoring will be conducted during drilling and soil sampling activities.

### **Decontamination**

Disposable PPE will be stored in a secured 55-gallon drum onsite. Monthly, a certified waste transporter and disposal company (ASWL Subcontractor) is contacted to transport the drum for disposal.

Water depth meters will be decon'd between depth recordings of individual monitoring wells using a clean metal bucket with distilled water and 1/10 parts cleaning solution.

### **Site Control**

AMEC personnel will be provided with a site map and be required to review the Health and Safety plan prior to entry into the site. A copy of this HASP shall be on hand at all times with emergency contact numbers and directions to the nearest medical facilities easily accessible. When necessary (e.g. quarterly sampling), cones, caution tape or a suitable alternative will be used to deny public access to the work area. Cones will also be used to define an exclusion zone redirecting motorists and pedestrians away from the work area.

In all emergencies AMEC is to document the action taken and notify the HSC, Project Manager and client official of the event and subsequent response.

### **In the Event of an Injury**

If an injury is life-threatening, follow steps 1 through 8 below. If the injury is not life threatening, perform necessary first aid and consider the need for decontamination prior to transport. The SSC shall be first aid and CPR trained.

- 1) Perform first aid necessary to determine victim(s) medical status
- 2) Call emergency transport.
- 3) Give specific directions to location of emergency
- 4) Give phone from which you are calling;
- 5) Tell emergency services what happened. Inform that victim(s) may be wearing contaminated clothing.
- 6) Inform emergency services how many persons need help.
- 7) Inform emergency services what is being done for the victim(s)
- 8) Stay on telephone until told to hang up.

Transport to hospital, if possible.

### **Work Permits**

Copies of the permits will be available onsite during drilling activities. Cascade Drilling will obtain start cards required for drilling from the Washington State Department of Ecology.

### **Security**

No unauthorized persons will be allowed in the work zone. Unauthorized persons are those without appropriate training, without proof of medical surveillance, and those with no business on the site.





# EMERGENCY MEDICAL ROUTE DIRECTIONS

2717 Federal Avenue, Everett, WA 98201

1. Head south on Federal Avenue towards Terminal Avenue.
2. Turn left at Terminal Avenue.
3. Continue on Everett Avenue/WA-529.
4. Turn left on Grand Avenue.
5. Turn right at 14th Street.
6. Turn left at Colby Avenue.

1321 Colby Avenue, Everett, WA 98201

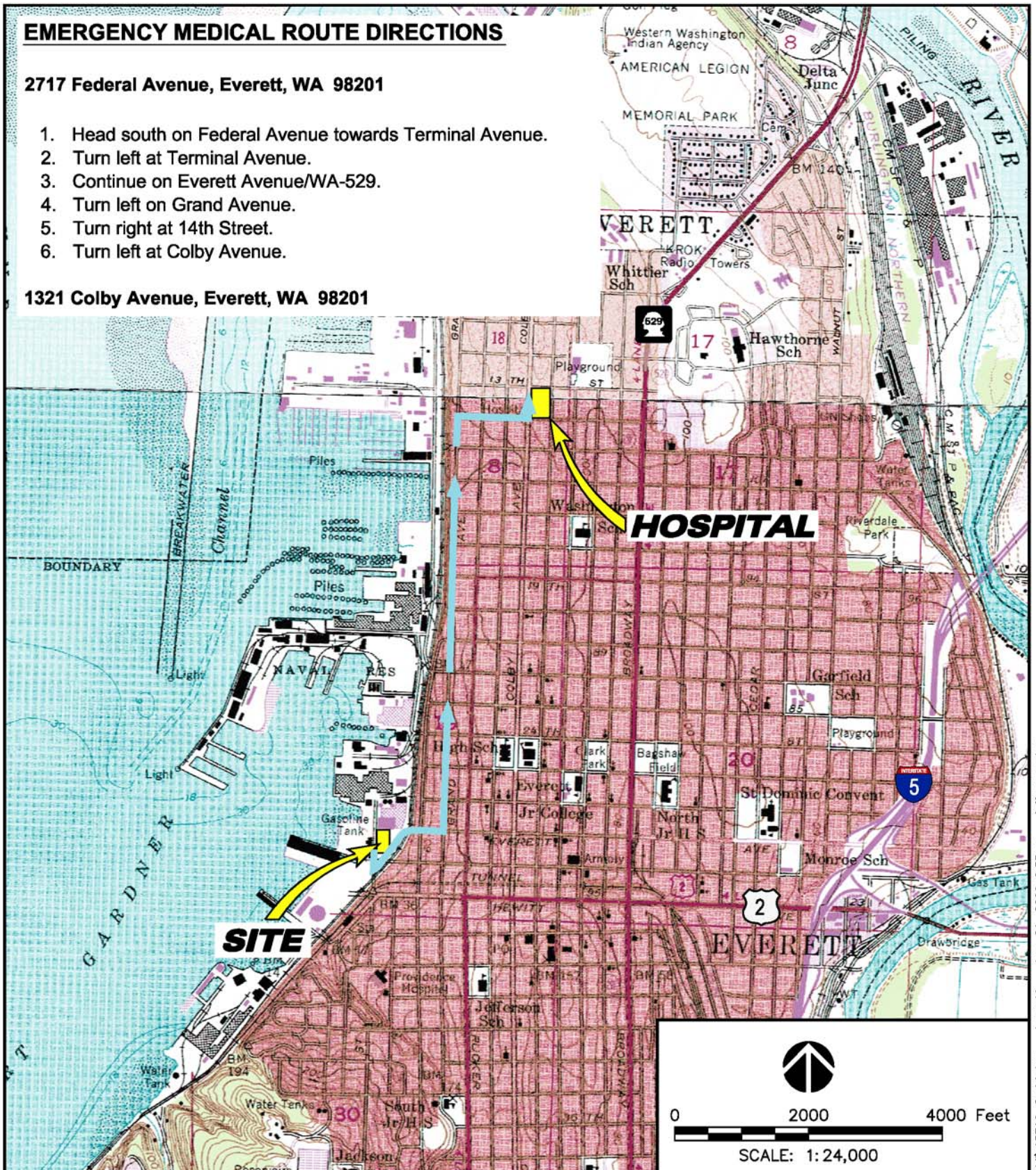

**AMEC Earth & Environmental**

11335 N.E. 122nd Way, Suite 100  
Kirkland, WA, U.S.A. 98034-6918



CLIENT LOGO

CLIENT

**EXXONMOBIL AND  
AMERICAN DISTRIBUTING COMPANY**

PROJECT: EXXONMOBIL/ADC PROPERTY, ECOLOGY SITE ID 2728

DWN BY:

JRS

DATUM:

NAD83

DATE: JUNE 2009

TITLE

**EMERGENCY MEDICAL ROUTE**

CHK'D BY:

AS

REV. NO.:

PROJECT NO:  
9-915-15716-C

PROJECTION:  
WA STATE PLANE

SCALE:  
AS SHOWN

FIGURE No.

## **ATTACHMENT A2**

Field Documentation Forms

**AMEC Earth & Environmental, Inc.**11810 North Creek Parkway N  
Bothell, Washington 98011Tel (425) 368-1000  
Fax (425) 368-1001**DAILY FIELD REPORT**

PROJECT NAME <b>Mobil/ADC Everett Facility</b>		PROJECT NO. <b>9915-15716-0</b>	FIELD REPORT NO.
ADDRESS <b>2717/2731 Federal Avenue</b>		DATE	PAGE  OF
CITY OR COUNTY <b>Everett, WA</b>	PERMIT NO.	ARRIVAL TIME	DEPARTURE TIME
CLIENT <b>ExxonMobil</b>	AMEC PROJECT MANAGER/PHONE NO.		
GENERAL CONTRACTOR	AMEC FIELD REPRESENTATIVE/ MOBILE NO.		
SUBCONTRACTOR	WEATHER		
TYPE OF WORK PERFORMED			
EQUIPMENT USED			

**COMMENTS**

--



# LOW-FLOW GROUNDWATER SAMPLING LOG

WELL NO: \_\_\_\_\_ LOCATION: \_\_\_\_\_ PROJECT NO: \_\_\_\_\_  
 DATE: \_\_\_\_\_ TIME: \_\_\_\_\_ CLIMATIC CONDITIONS: \_\_\_\_\_  
 OVA/PID READING WHEN WELL OPENED: \_\_\_\_\_ DEPTH TO PRODUCT (TOC): \_\_\_\_\_  
 STATIC WATER LEVEL (TOC): \_\_\_\_\_ TOTAL DEPTH OF WELL (TOC): \_\_\_\_\_

METHOD OF REMOVAL: \_\_\_\_\_ PUMPING RATE: \_\_\_\_\_

WELL	DTW	Time	Gallons	Temp.	pH	Sp. Cond.	Turbidity	DO	REDOX
			Removed	(C°)		(mS/cm)	(NTU)	(mg/L)	(mv)
PURGE	_____	_____	_____	_____	_____	_____	_____	_____	_____
DATA	_____	_____	_____	_____	_____	_____	_____	_____	_____
	_____	_____	_____	_____	_____	_____	_____	_____	_____
	_____	_____	_____	_____	_____	_____	_____	_____	_____
	_____	_____	_____	_____	_____	_____	_____	_____	_____
	_____	_____	_____	_____	_____	_____	_____	_____	_____
	_____	_____	_____	_____	_____	_____	_____	_____	_____
	_____	_____	_____	_____	_____	_____	_____	_____	_____
	_____	_____	_____	_____	_____	_____	_____	_____	_____
	_____	_____	_____	_____	_____	_____	_____	_____	_____
	_____	_____	_____	_____	_____	_____	_____	_____	_____
	_____	_____	_____	_____	_____	_____	_____	_____	_____
	_____	_____	_____	_____	_____	_____	_____	_____	_____
	_____	_____	_____	_____	_____	_____	_____	_____	_____
	_____	_____	_____	_____	_____	_____	_____	_____	_____
	_____	_____	_____	_____	_____	_____	_____	_____	_____
	_____	_____	_____	_____	_____	_____	_____	_____	_____
	_____	_____	_____	_____	_____	_____	_____	_____	_____
	_____	_____	_____	_____	_____	_____	_____	_____	_____
	_____	_____	_____	_____	_____	_____	_____	_____	_____

SAMPLE WITHDRAWAL METHOD: \_\_\_\_\_ SAMPLED BY: \_\_\_\_\_  
 SAMPLE NUMBER(S) AND TIME: \_\_\_\_\_

NOTES: \_\_\_\_\_

LAB ANALYSIS PARAMETERS AND PRESERVATIVES: \_\_\_\_\_  
 \_\_\_\_\_  
 \_\_\_\_\_

NUMBER AND TYPES OF SAMPLE CONTAINERS USED: \_\_\_\_\_  
 \_\_\_\_\_  
 \_\_\_\_\_

DECON. PROCEDURES: \_\_\_\_\_  
 \_\_\_\_\_

SAMPLES DELIVERED TO: \_\_\_\_\_ TRANSPORTER: \_\_\_\_\_  
 DATE: \_\_\_\_\_ TIME: \_\_\_\_\_

CAPACITY OF CASING (GALLONS/LINEAR FOOT)  
 2" - 0.16 • 4" - 0.65 • 6" - 1.47 • 8" - 2.61 • 10" - 4.08 • 12" - 5.57



PROJECT NAME	PROJECT NO. _____	WELL NO. _____
RES FIELD REPRESENTATIVE	DATE BEGUN	DATE COMPLETED
DRILLING CONTRACTOR	INSTALLATION TIME	BIOLOGY I.D. NO.

### WELL CONSTRUCTION DIAGRAM

SOIL TYPE \_\_\_\_\_ SLOPE FEET \_\_\_\_\_ DEPTH FEET \_\_\_\_\_

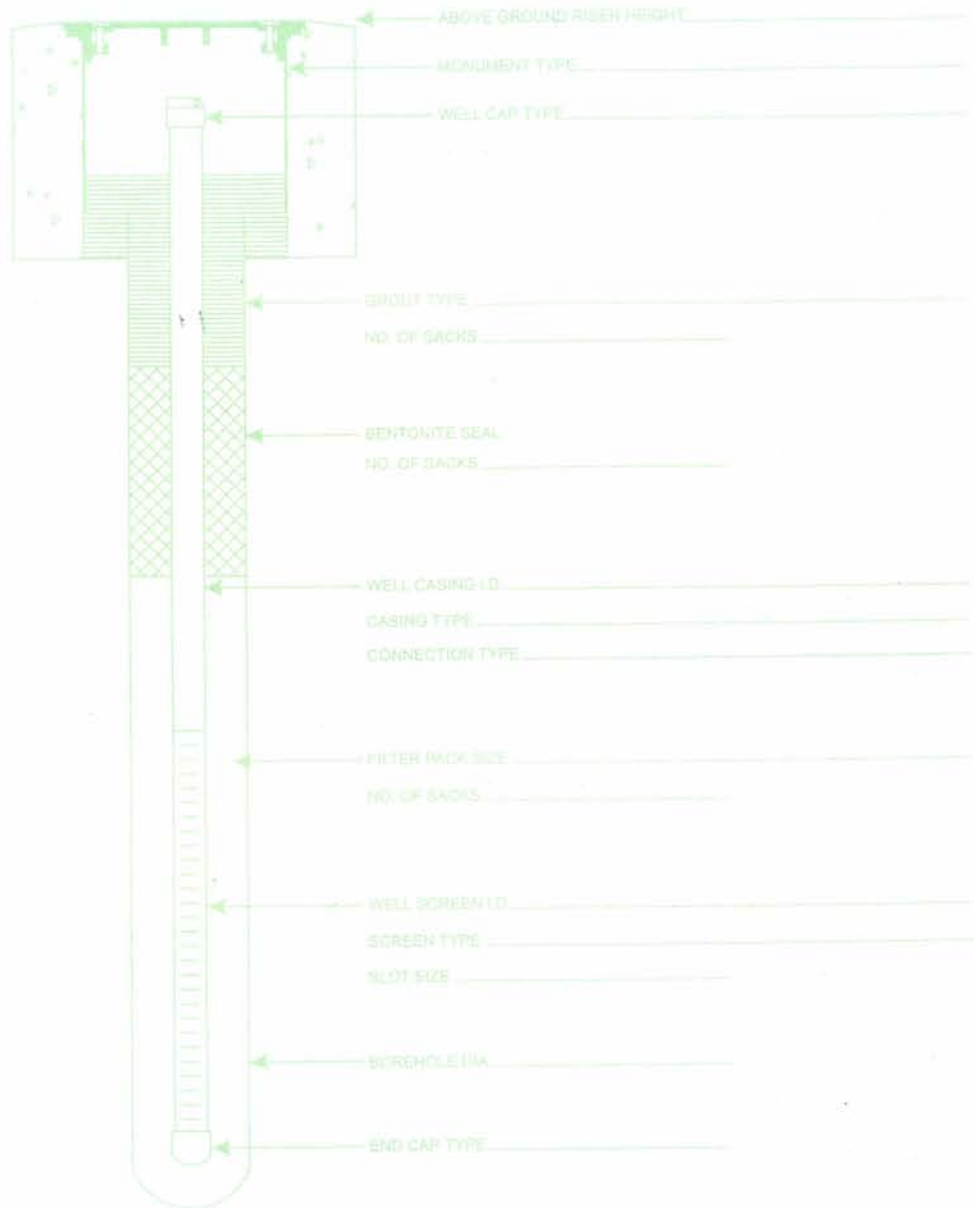
### COMMENTS

**Chain of Custody Record**



TestAmerica Laboratories, Inc.

<b>Client Contact</b>			<b>Project Manager: Leah Vigoren</b>		<b>Site Contact: Leah Vigoren</b>		<b>Date:</b>		
AMEC Earth & Environmental, Inc.			Tel/Fax: (206) 838-8470		Lab Contact:		Carrier:		
600 University Street Suite 1020			Analysis Turnaround Time						COC No: _____ of _____ COCs
Seattle, WA 98101			Calendar ( C ) or Work Days (W) _____		Job No. _____				
(206) 342-1760			TAT if different from Below _____		SDG No. _____				
(206) 342-1761			<input type="checkbox"/> 2 weeks		Sample Specific Notes:				
Phone			<input type="checkbox"/> 1 week						
FAX			<input type="checkbox"/> 2 days						
Project Name: ExxonMobil/ADC			<input type="checkbox"/> 1 day		Filtered Sample				
Site: Everett			<input type="checkbox"/> 1 day						
P O # 9915-15716C			<b>Sample Identification</b>			<b>Sample Type</b>			
			Sample Date	Sample Time	Sample Matrix	# of Cont.			

Preservation Used: 1= Ice, 2= HCl; 3= H2SO4; 4=HNO3; 5=NaOH; 6= Other \_\_\_\_\_

Possible Hazard Identification

Non-Hazard  Flammable  Skin Irritant  Poison B  Unknown

Special Instructions/QC Requirements & Comments: Send electronic data to leah.vigoren@amec.com

Relinquished by: _____ Relinquished by: _____ Relinquished by: _____	Received by: _____ Received by: _____ Received by: _____
Company: _____	Company: _____
Date/Time: _____	Date/Time: _____

Sample Disposal ( A fee may be assessed if samples are retained longer than 1 month ) <input type="checkbox"/> Return To Client <input type="checkbox"/> Disposal By Lab <input type="checkbox"/> Archive For _____ Months	
Relinquished by: _____ Relinquished by: _____ Relinquished by: _____	Received by: _____ Received by: _____ Received by: _____
Company: _____	Company: _____
Date/Time: _____	Date/Time: _____



<b>WELL DEVELOPMENT LOG</b>	<b>PROJECT</b>	<b>WELL NO.</b>	
	<b>JOB NO.</b>	<b>DATE</b>	<b>PREPARED BY</b>

METHOD OVERPUMPAGE _____  BAILER _____ SURGE _____ BLOCK _____  AIR LIFT _____  OTHER _____	INITIAL WATER LEVEL _____  FINAL WATER LEVEL _____  CAPACITY OF CASING (GALLONS/LINEAR FOOT)  2" = 0.16 4" = 0.65 6" = 1.47	REMARKS:   VOLUME BETWEEN CASING AND HOLE (GALLONS/LINEAR FOOT) (ASSUMING 40% POROSITY)  2" CASING AND 6" HOLE - 0.52 2" CASING AND 8" HOLE - 0.98 4" CASING AND 10" HOLE = 1.37 4" CASING AND 12" HOLE - 2.09
--	--	--

HOLE DIAMETER $d_h$ = _____  WELL CASING INSIDE DIAMETER $d_wID$ = _____  OUTSIDE DIAMETER $d_wOD$ = _____  DEPTH TO: WATER LEVEL $H$ = _____  BASE OF SEAL $S$ = _____  BASE OF WELL $TD$ = _____  EST. FILTER PACK POROSITY $P$ = _____		<b>WELL VOLUME CALCULATION:</b>  $CASING VOLUME = V_c = \pi \left( \frac{d_wID}{2} \right)^2 (TD - H) = 3.14 \left( \frac{\quad}{2} \right)^2 (\quad - \quad) = \quad$  $FILTER PACK PORE VOLUME = V_f = \pi \left[ \left( \frac{d_h}{2} \right)^2 - \left( \frac{d_wOD}{2} \right)^2 \right] (TD - (S \text{ or } H * (P))) = \quad$ (*if $S > H$ , use $S$ ; if $S < H$ , use $H$ )  $= 3.14 \left[ \left( \frac{\quad}{2} \right)^2 - \left( \frac{\quad}{2} \right)^2 \right] (\quad - \quad) (\quad) = \quad$  <b>TOTAL WELL VOLUME = <math>V_T = V_c + V_f = \quad + \quad = \quad</math> ft.<sup>3</sup> x 7.48 = <math>\quad</math> gal.</b>
---	--	---

DEVELOPMENT LOG:					CUMULATIVE WATER REMOVED GALLONS	WATER QUALITY					COMMENTS	
DTW	TIME BEGIN/END	METHOD	ELAPSED TIME	FLOW RATE (gpm)		pH	TEMP	CONDUCT- TIVITY	D.O.*	REDOX		TURBID- ITY

\* = Dissolved Oxygen



## **APPENDIX B**

Historical Maps and Documentation

# INSURANCE MAPS of **NEW YORK** WASHINGTON Published in 1902 by the **SANBORN MAP COMPANY** 11 Broadway, New York

Scale of 1 inch to 10 miles

COPYRIGHT, 1902, by the SANBORN MAP COMPANY

THE LIBRARY OF  
 THE CONGRESS  
 FEB 1 1902  
 DISTRICT OF COLUMBIA

## INDEX

115-2877 24	Brett Ave.,	3500-3610 41	Hoyt Ave.,	2700-2838 10	Pacific Ave.,	1000-1224 38	Summit Ave.,	5000-5058 40	Twenty-second,	1900-1921 33	Bell-Yelton Mill Co.,	51
00-2833 43	"	3501-3523 43	"	2701-2838 10	"	1001-1123 43	"	2210-2235 39	"	1900-1791 23	Blackman, C.A., & Co.,	46
00-2950 2	"	3601-3615 45	"	2800-3033 9	"	1201-1424 9	"	2501-2537 40	"	1801-1808 28	Shoemaker,	51
27-2838 28	"	3612-3610 45	St., at Lowel,	2901-3035 16	"	1400-1424 4	"	2500-2631 38	"	1801-1809 22	Carpenter Bros.,	28
				3100-3214 4	"	1600-1724 17	"	2700-2838 41	"	1810-2109 28	Shingler Mill,	28
				3101-3233 11	"	1801-1723 16	"	2700-2723 34	"	Casadio Steam Laundry,	28	28
					"	1801-1723 16	"		"			

4

5

2

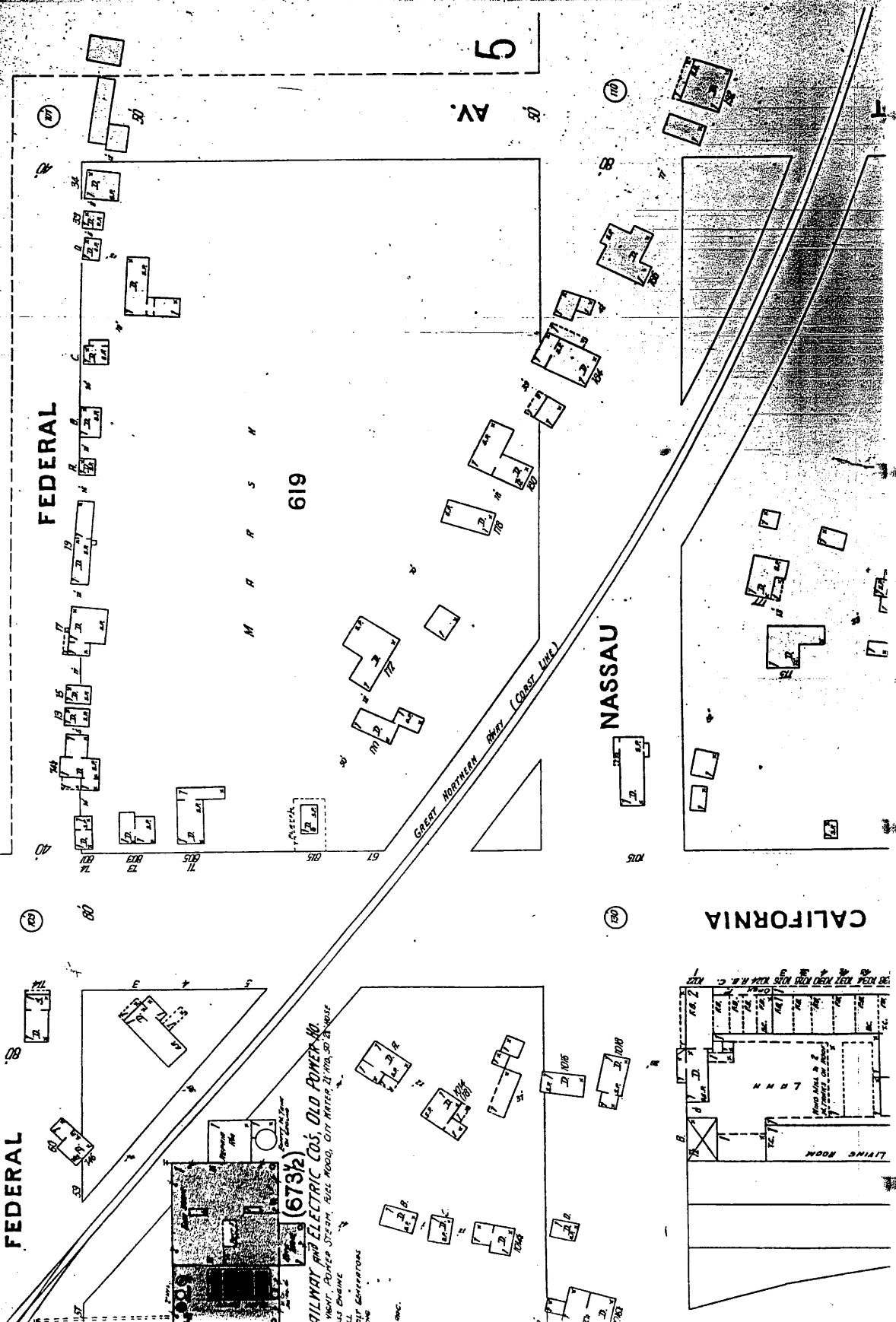

FEDERAL

619

GREAT NORTHERN R.R. (CROSSING)

NASSAU

CALIFORNIA

FEDERAL

RAILWAY AND ELECTRIC CO'S. OLD POWER HO.  
 WIND, POWER STEAM, FUEL HOOD, OIL WATER 21/2 GAL. 50 GALLON  
 450 ENGINE  
 AIR GENERATOR

(673 1/2)

LIVING ROOM

WOOD SHED

INSURANCE

JUN 10 1914

MAPS OF

# REPORT

INCLUDING

# LOWELL

# WASHINGTON

PUBLISHED BY THE

## SANBORN MAP COMPANY

11 BROADWAY, NEW YORK

# 1914

Copyright 1914 by the Sanborn Map Company

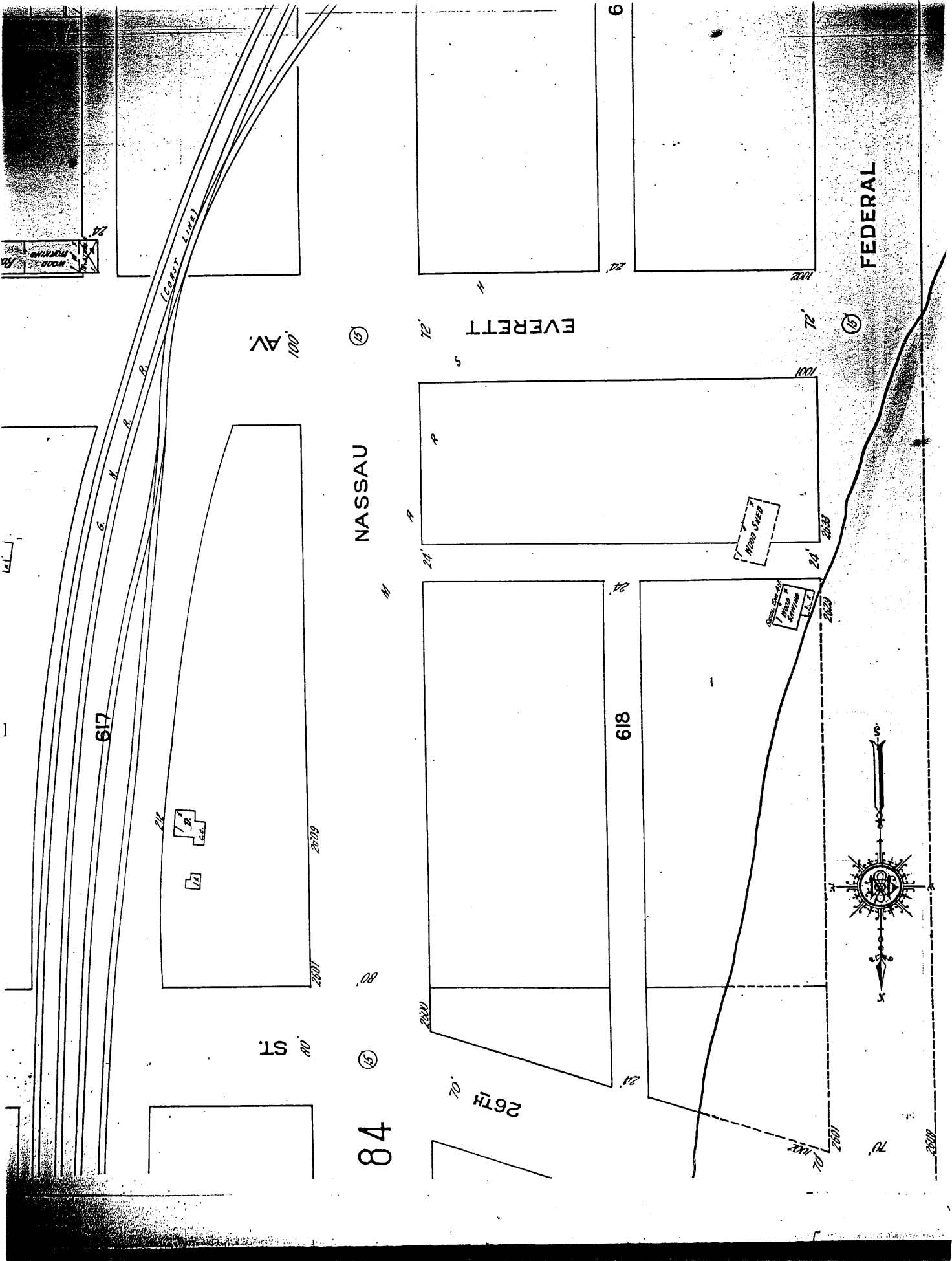

American Oil  
Drilling Company Site

FEDERAL ST

Edge of road along beach 90 to 91

2' Section for Exp. Dist. only

14

13

12

11

10

9

8

7

6

5

4

3

2

1

Swamp Elev. 87-

EVERETT AVE

NASSAU ST

3' Section for Exp. Dist. only



The regular Administrative Session of the City Council was held August 16, 1915, at 10:30 A.M. with Mayor Clay in the Chair and Commissioners Clay, Kelly and Salter present at roll call.

On motion minutes approved as of record.

Moved by Kelly, seconded by Salter, that bills of A. C. Chilson for \$6.00 and H. J. Linden for \$11.65 for services as registration clerks be allowed and ordered paid.

Carried unanimously

Moved by Kelly, seconded by Salter that the City Attorney be instructed to prepare an ordinance covering the installation of oil tanks north of the G. N. Dock.

Carried unanimously

Moved by Kelly, seconded by Clay that the City Attorney be instructed to prepare an ordinance regulating the speed of Street Railway cars to conform to the speed allowed autos.

Carried unanimously

On motion Council adjourned at 11:00 A. M.

Louis Lee  
City Clerk

EXHIBIT

D

ORDINANCE NO. 1674

An ordinance granting to the Standard Oil Company, a corporation, a permit to locate, erect, operate and maintain a warehouse or tankage, or both, and other necessary buildings, on a certain tract of land in the city of Everett described as follows: Lot 1, block 619, Plat of Everett, at the corner of Everett Avenue and Federal Street, for the storage and distribution of petroleum and its products, and other kinds of merchandise, by said company, and declaring an emergency.

THE CITY OF EVERETT DOES ORDAIN:

Section 1: That the Standard Oil Company, a corporation, be and it is hereby granted permission to locate, erect, operate and maintain a warehouse or tankage, or both, and other necessary buildings, upon that certain tract of land in the city of Everett described as follows: Lot 1, block 619, Plat of Everett, at the corner of Everett Avenue and Federal Street, for the storage and distribution of petroleum and its products, and other kinds of merchandise handled by said company, said warehouse, tankage and buildings to be constructed in accordance with the plans and specifications therefor filed by said company with the city clerk of the city of Everett and now on file in the office of said clerk.

Section 2: WHEREAS, it is desirous to begin the construction of said warehouse, tankage and buildings immediately, an emergency is declared to exist, and this ordinance shall take effect upon its passage and publication.

W. H. Lay  
Mayor.

Passed AUG 24 1915

Attest Louis Lill  
City Clerk.

EXHIBIT E

Published AUG 26 1915



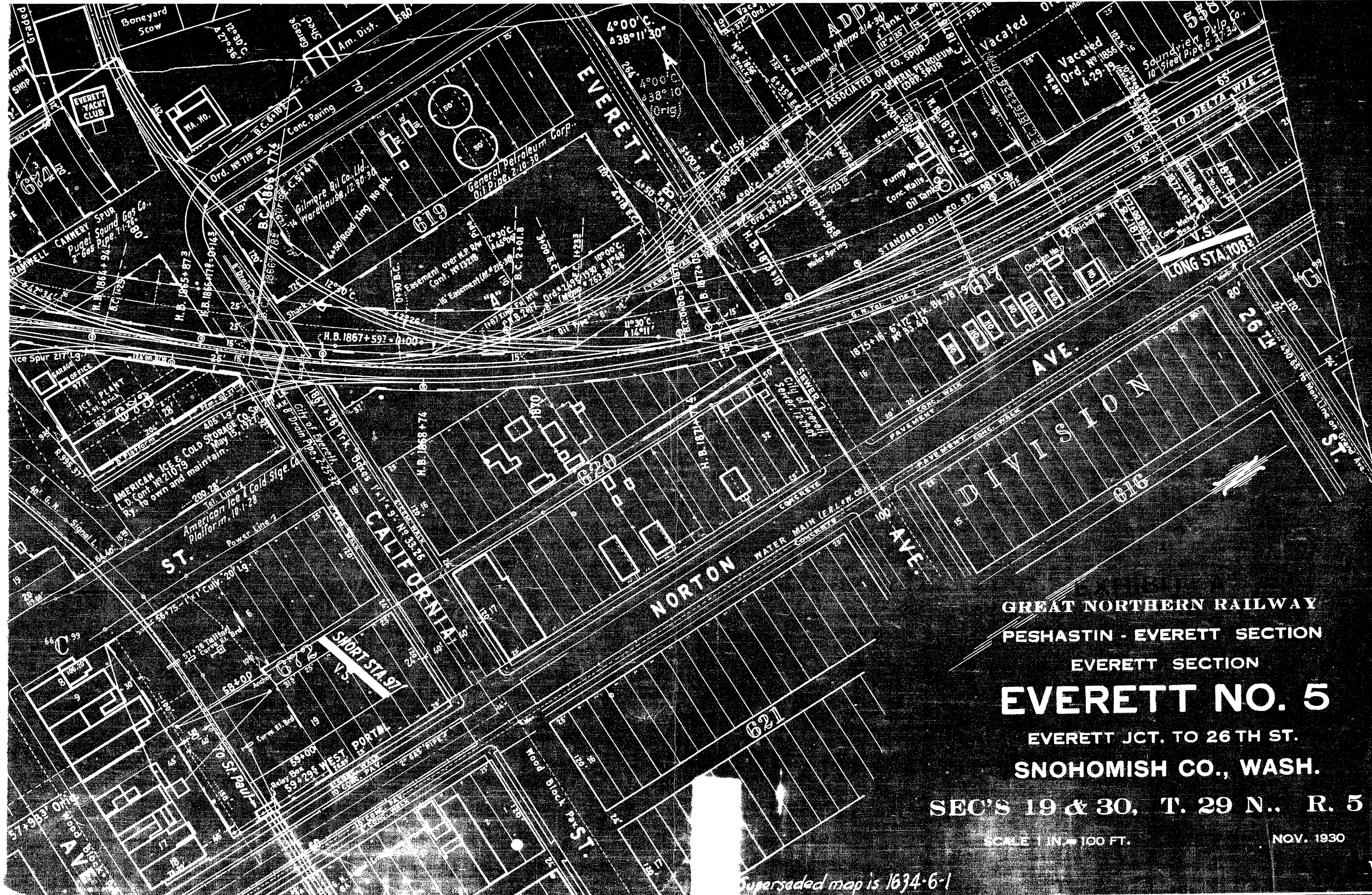

GREAT NORTHERN RAILWAY  
 PESHASTIN - EVERETT SECTION  
 EVERETT SECTION  
**EVERETT NO. 5**  
 EVERETT JCT. TO 26 TH ST.  
 SNOHOMISH CO., WASH.  
 SEC'S 19 & 30, T. 29 N., R. 5 E.

SCALE 1 IN. = 100 FT. NOV. 1930

Superseded map is 1634-6-1

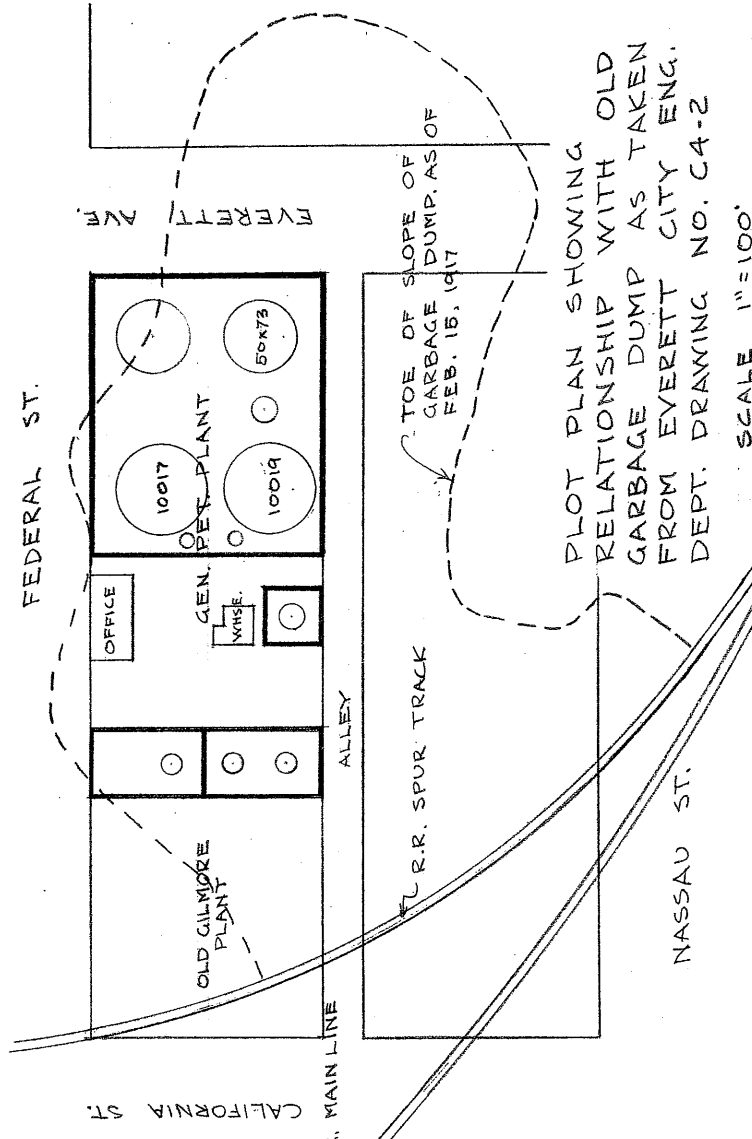
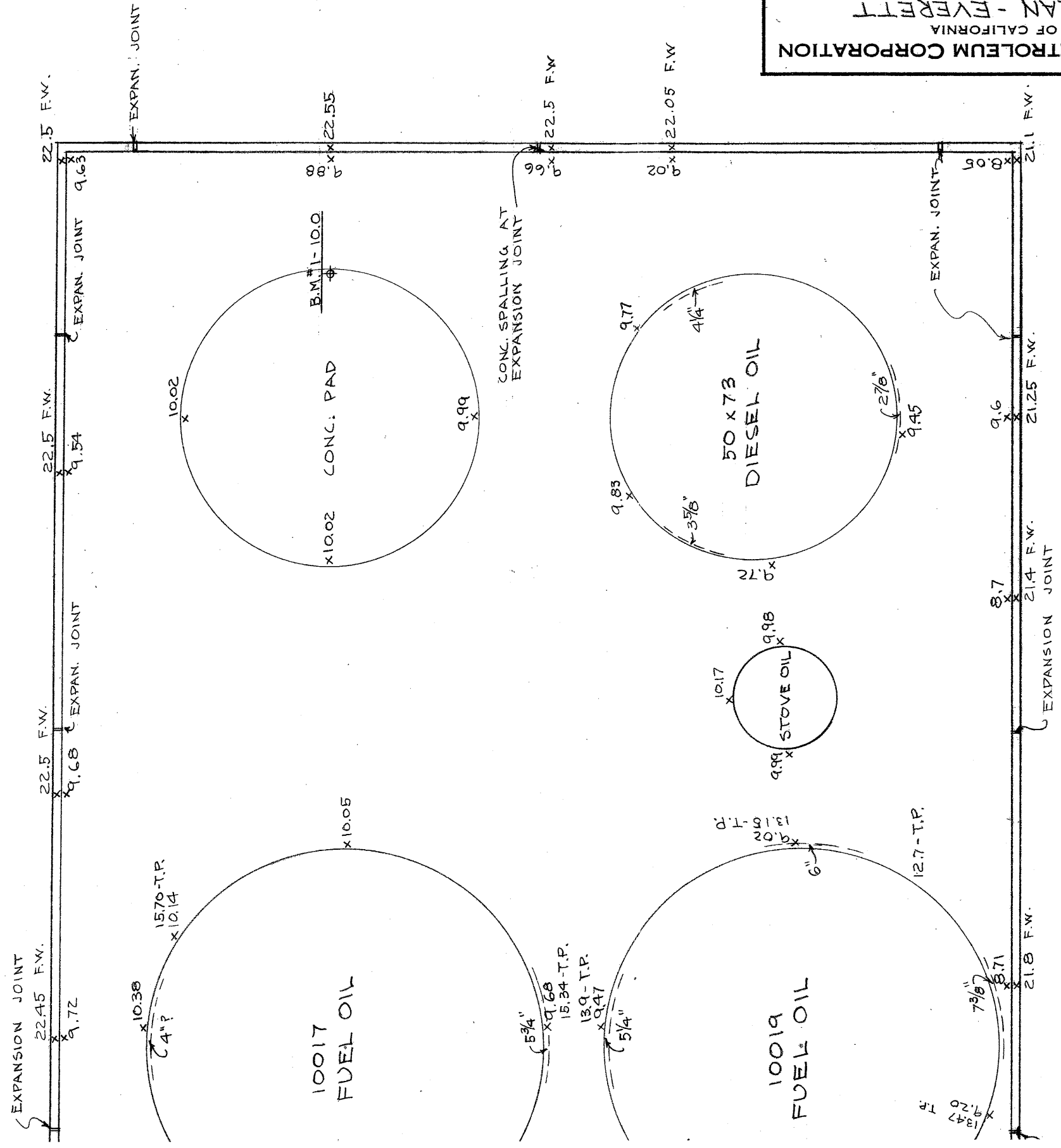

TO  
-OM  
WALL  
OF  
AT  
HAS  
NEAR  
:CTION  
: PLUMB

IND	DESCRIPTION	BY	DATE	APPROVED

DWG. NO. 2M-371

SCALE 1/4" = 1.0"

DRAWN J.D.D.

DATE 4-8-46

CHECKED

APPROVED

GENERAL PETROLEUM CORPORATION  
OF CALIFORNIA  
PLOT PLAN - EVERETT  
PLANT - SHOWING YARD  
& TANK ELEVATIONS  
WASHINGTON DIVISION  
SEATTLE, WASH.

GEN. DET. EVERETT CITY DATUM  
ELEV.

B.M. 10.00	=	108.92
7.74	=	106.66
4.24	=	103.16
-6.24	=	92.68
-10.24	=	88.68

EXTREME HIGH WATER  
MEAN HIGH WATER  
MEAN LOWER LOW WATER  
EXTREME LOW WATER

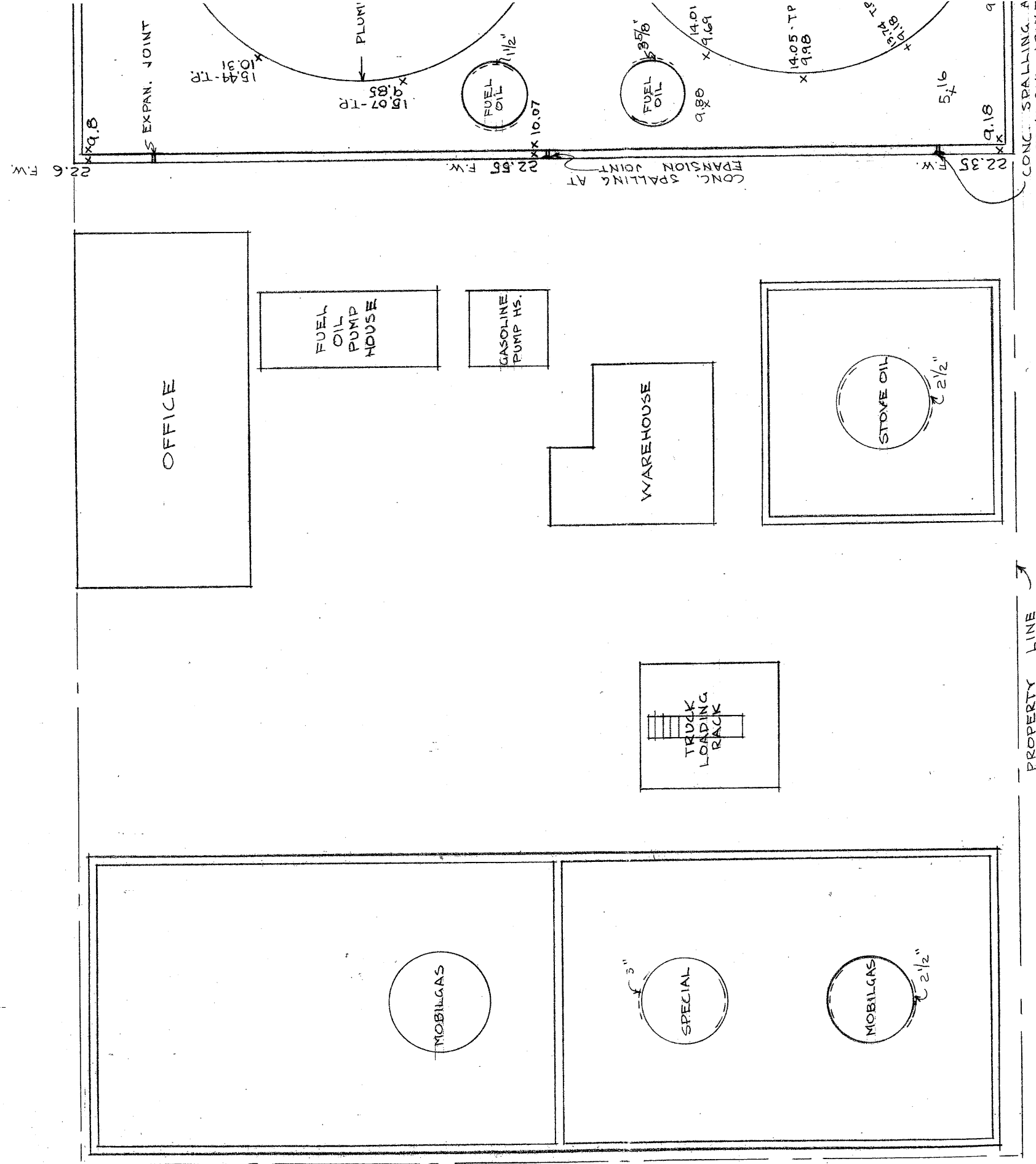

NOTES

ELEVATIONS EXCEPT AS INDICATED BELOW ARE YARD GROUND LEVELS  
T.P. INDICATES ELEVATION AT TOP OF 5' PLATE COURSE  
F.W. INDICATES ELEVATION AT TOP OF F  
ELEVATIONS SHOWN AROUND OUTSIDE EDGE OF TANKS ARE TO TOP OF CONC. PAD EXCEPT TANK NO. 10019 WHERE ORIGINAL RING PAD IS SUNK AND BEEN COVERED WITH DIRT  
DOTTED LINES AND DIMENSIONS IN INCHES OUTSIDE EDGE OF TANKS INDICATE THE D AND DISTANCE IN WHICH THEY ARE OUT

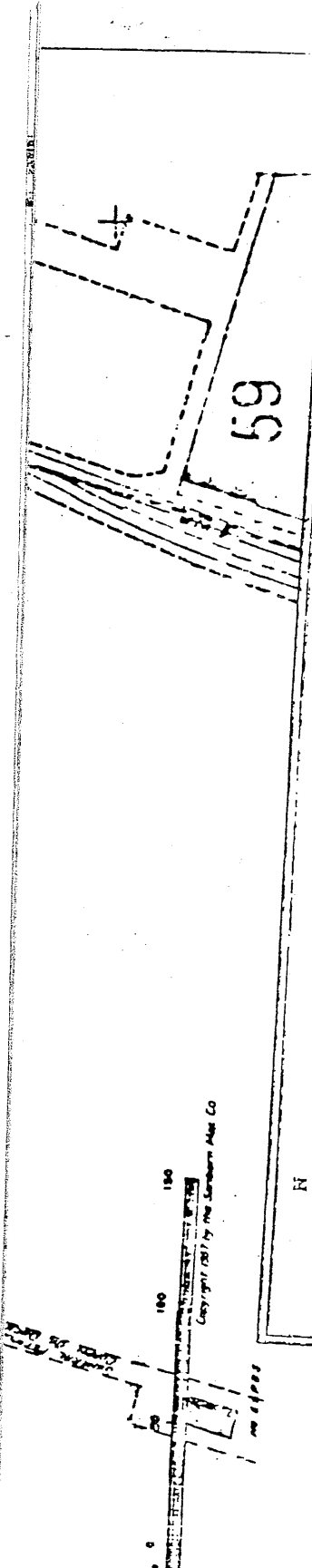

100 150  
 Copyright 1957 by The Sanborn Map Co

# EDR Sanborn, Inc.

This Sanborn<sup>TM</sup> map is a carbon copy produced by EDR Sanborn, Inc. from its archives. Information on this map is derived from Sanborn field surveys conducted in:

**© 1957**  
 Year

**RAC**

EDR Sanborn, Inc. Research Associates

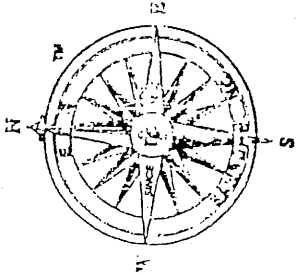

Reproduction in whole or in part of any EDR Sanborn<sup>TM</sup> particular from EDR Sanborn, Inc.

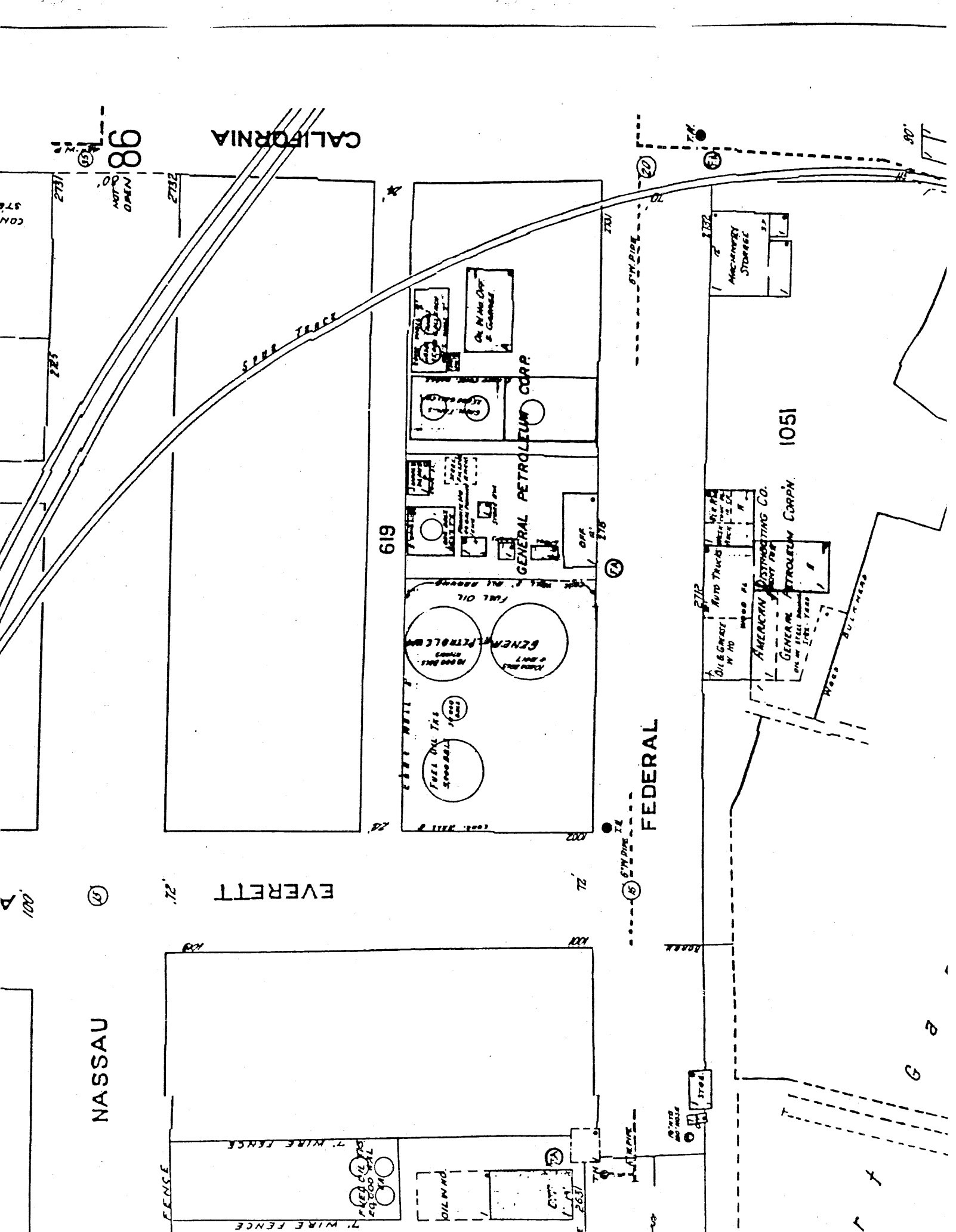

CALIFORNIA

86

CON 974

522

1001

NASSAU

EVERETT

619

GENERAL PETROLEUM CORP.

FEDERAL

1051

AMERICAN DISTRICTING CO.  
GENERAL PETROLEUM CORP.

Oil & Gasoline in HD  
Auto Trucks

MACHINERY STORAGE

FUEL OIL TANKS  
GENERAL PETROLEUM

Oil in HD Cyls & Containers

WATER BULKHEAD

OIL IN HD

CON. WALL

SEWER

ROAD

29

x

r

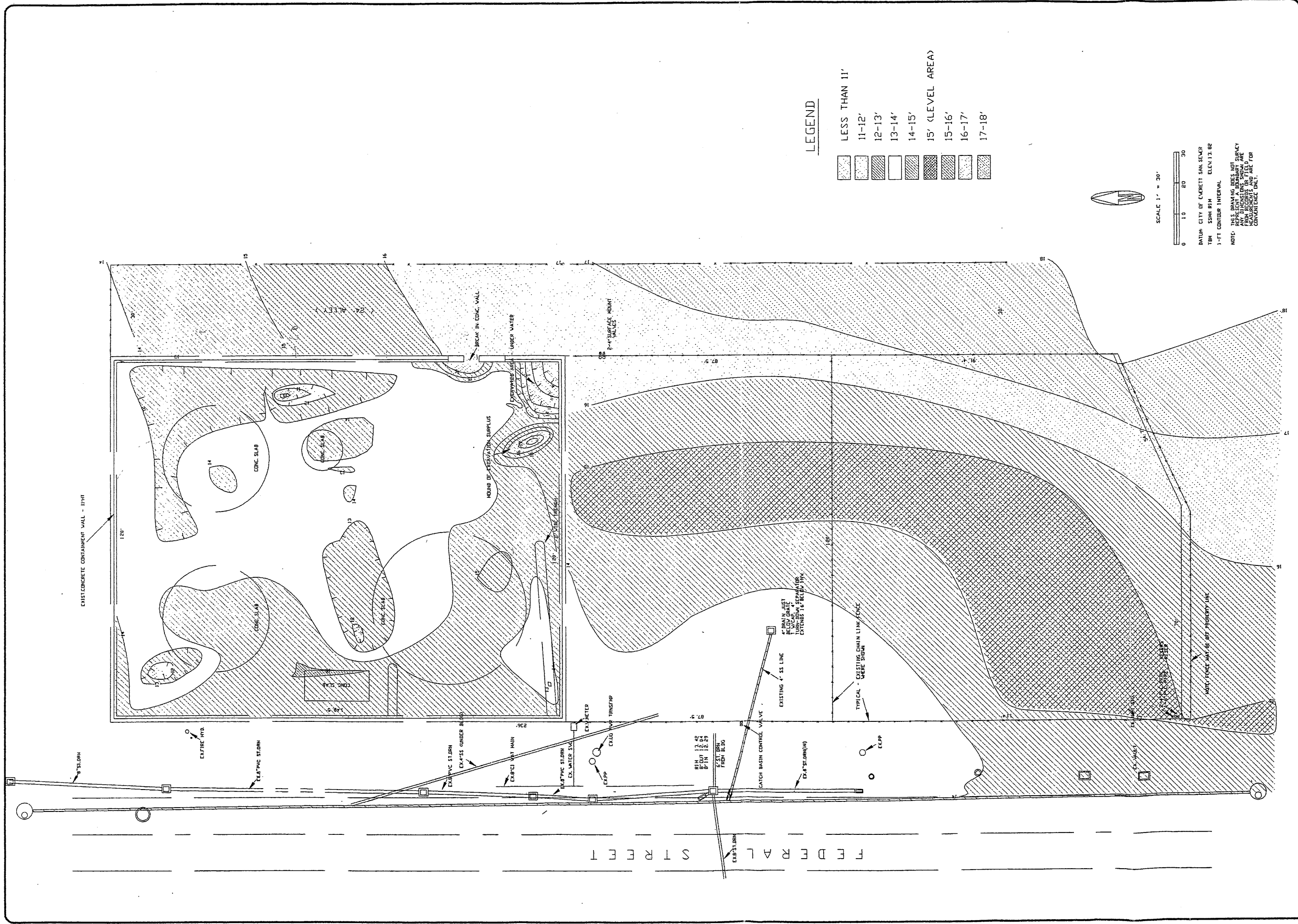

**LEGEND**

- LESS THAN 11'
- 11-12'
- 12-13'
- 13-14'
- 14-15'
- 15' (LEVEL AREA)
- 15-16'
- 16-17'
- 17-18'

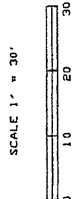

SCALE 1" = 30'

DATUM: CITY OF EVERETT SAN. SEWER  
 TBM SSIM RIM ELEV. 12.82  
 1-FT CONTOUR INTERVAL

NOTE: THIS DRAWING DOES NOT  
 REPRESENT A BOUNDARY SURVEY  
 AND IS NOT TO BE USED FOR  
 MEASUREMENTS AND ARE FOR  
 CONVENTIONAL ONLY.



Mobil Oil  
 ADC/Miller Property  
 2701-2717 Federal Avenue  
 Everett, Washington  
 Project: 60-1914-08

11/11/98

**EXISTING TOPOGRAPHIC  
 CONTOURS**

FIGURE

11



PRIVILEGED AND CONFIDENTIAL  
ATTORNEY-CLIENT COMMUNICATION  
ATTORNEY WORK PRODUCT

December 27, 2006  
6-914-15716-0

ExxonMobil–Global Remediation  
4580 Klahanie Drive SE PMB 507  
Issaquah, Washington 98029

Attention: Mr. Tim Strawn

**Subject: Forensic Evaluation of Petroleum  
Hydrocarbons ExxonMobil and ADC/Miller  
Parcel**  
2717/2731 Federal Avenue  
Everett, Washington

Dear Mr. Strawn:

AMEC Earth & Environmental, Inc. (AMEC) has prepared this letter in response to the request from ExxonMobil to review forensic data from NewFields Environmental Practice, LLC (NewFields) for the former Mobil Oil/American Distribution Corporation (ADC) Terminal at 2717/2713 Federal Avenue, Everett, Washington (the Site).

AMEC chemists reviewed the report titled *Chemical Characterization of NAPL Samples Former Mobil Oil Terminal (46-108), Everett, Washington* (NAPL Report), prepared by NewFields dated May 31, 2006, along with data supplied by NewFields from chemical analysis performed by Alpha Analytical Woods Hole Laboratory of Woods Hole, Massachusetts (AWHL). A copy of the New Fields report and AWHL data are attached as Exhibit 1. The NAPL Report presents an evaluation of data generated by AWHL for three light nonaqueous phase liquid (LNAPL) samples, designated MW-29, W-1, and W-2. Sample MW-29 and sample W-1 were collected from monitoring wells at the Site, while sample W-2 was collected from an off-site location. A map of the Site, showing the location of the groundwater monitoring wells is attached to this letter as Exhibit 2.

This review was performed by AMEC on behalf of ExxonMobil in order to evaluate whether findings presented in the NAPL Report were consistent with the analytical data from AWHL, and to identify whether the analytical data was suggestive of the possible presence of off-site sources of the petroleum hydrocarbons in LNAPL samples collected.

Based on examination of the data included with the NAPL Report, AMEC concludes that LNAPL samples collected from on-site wells MW-29 and W-1 are similar to each other, but different from LNAPL collected from off-site well W-2, and that the presence of LNAPL in W-2 is not a result of transport of petroleum hydrocarbons from the on-site wells, MW-29 and W-1, to the off-site well, W-2.

**PRIVILEGED AND CONFIDENTIAL  
ATTORNEY-CLIENT COMMUNICATION  
ATTORNEY WORK PRODUCT**

The remainder of this letter will present specific details of AMEC's evaluation of the NAPL Report. The associated data, as related to the visual examination of bulk composition using chromatograms from whole oil analysis LNAPL samples, and a discussion of the specific diagnostic ratios of biomarkers and sulfur-bearing compounds taken from the detailed chemical analyses performed by AWHL for Newfields (as shown in the NAPL Report) will also be presented.

### **Evaluation of Bulk Composition of LNAPLs from On-site and Off-site Wells**

Based on AMEC's inspection of whole oil chromatograms from samples MW-29, W-1 and W-2, as presented in the Newfields Report (see Page 3 of Exhibit 1), the following conclusions about bulk composition of LNAPL from the three samples can be drawn:

- The two on-site LNAPL samples (MW-29 and W-1) appear to be predominantly mixtures of degraded diesel mixed with degraded gasoline and small amounts of residual-range hydrocarbons. The diesel-range chromatograms for the on-site samples exhibit a non-typical diesel pattern, which is likely the result of gasoline present in LNAPL and enhanced solubilization of organic materials from the surrounding soil caused by the gasoline, as opposed to straight diesel.
- LNAPL from the off-site sample (W-2) appears to consist predominantly of highly degraded diesel with only a trace amount of gasoline. Based on visual examination of the whole oil chromatograms, the diesel in sample W-2 appears much more degraded than the diesel in the on-site samples, and is likely from a much older release.
- NAPL samples from MW-29, W-1, and W-2 all contain residual-range hydrocarbons. No quantitative results for gasoline, diesel, or residual-range petroleum hydrocarbons were included in the NAPL report, but based on visual examination of the whole oil chromatograms, relative concentrations of residual-range hydrocarbons appear to be higher in the on-site samples (MW-29, and W-1) than the off-site sample (W-2), possibly due to enhanced solubilization of asphalt or other high molecular weight petroleum hydrocarbons from soil or fill due to the presence of gasoline.
- In the professional opinion of AMEC, based on the visual inspection of the two Total Petroleum Hydrocarbon (TPH) chromatograms for MW-29 and W-1, LNAPL collected from MW-29 appears less degraded than LNAPL collected from W-1. LNAPL collected from MW-29 also appears to have a higher abundance of gasoline-range compounds relative to diesel-range compounds than LNAPL collected from MW-1. As stated above, both on-site LNAPL samples appear to be less degraded than LNAPL collected from off-site well W-2.



**PRIVILEGED AND CONFIDENTIAL  
ATTORNEY-CLIENT COMMUNICATION  
ATTORNEY WORK PRODUCT**

## **Examination of Diagnostic Ratios Related to Sulfur Content, and Select Biomarkers**

The most direct evidence that LNAPL samples collected from on-site wells MW-29 and W-1 are similar to each other, but different from LNAPL collected from off-site well W-2, involves comparison of relative sulfur concentrations in LNAPLs from the three wells using diagnostic ratios of the concentrations of dibenzothiopenes (sulfur-containing polycyclic aromatic hydrocarbons [PAH] analogs) to phenanthrenes (sulfur-free PAHs). In the NAPL Report, ratios of C<sub>2</sub>-substituted dibenzothiopenes to the sum of C<sub>2</sub>-substituted dibenzothiopenes and C<sub>2</sub>-substituted phenanthrenes were plotted against ratios of C<sub>3</sub>-substituted dibenzothiopenes to the sum of C<sub>3</sub>-substituted dibenzothiopenes and C<sub>3</sub>-substituted phenanthrenes in order to allow comparison of relative sulfur abundances between the three LNAPL samples. The resulting plots (see Exhibit 1, page 6, Figure 3) demonstrate that LNAPL samples collected from MW-29 and W-1 had sulfur abundances similar to each other, but distinct from, and lower than, the sulfur abundance for LNAPL collected from W-2. Based on this analysis, LNAPLs in MW-29 and W-1 are derived from a petroleum source that has a lower sulfur concentration than the petroleum source from which LNAPL in W-2 is derived.

Alkylcyclohexanes are a family of petroleum constituents that are resistant to degradation, and that have been used as forensic markers in multiple investigations involving diesel fuels, as their concentration in diesel fuels is typically greater than the concentrations of many other biomarker families. Inspection of the m/z 83 ion chromatograms (see pages 33–36 of Exhibit 1), which corresponds to the molecular weight of the base ion for alkylcyclohexane compounds, also reinforces the assertion that LNAPL samples collected from MW-29 and W-1 are similar to each other, but distinct from LNAPL collected at W-2. The chromatographic traces from MW-29 and W-1 exhibited unresolved chromatographic envelopes (UCEs) with similar retention times, but slightly differing peak patterns. The peak pattern for LNAPL collected from MW-29 exhibits higher relative contributions by early-eluting peaks than the peak pattern from LNAPL collected at W-1, and although enhancement of lower molecular weight alkylcyclohexanes can sometimes be related to degradation of higher molecular weight alkylcyclohexanes (a sign of a more highly degraded material), the pattern of peaks in this case does not support that assertion, but is strongly indicative of a less degraded sample. The m/z 83 ion chromatogram for the LNAPL sample collected from W-2, on the other hand, shows nearly universal decreases in peak height for all the alkylcyclohexanes compared to the matching peaks for sample MW-29 and W-1, again indicating that the diesel component of LNAPL in W-2 originated from an older release.

Retene is a naturally-occurring PAH often associated with coniferous resins or other higher plant matter. The retene concentration detected in the LNAPL collected from W-1 is more than two-fold higher than the retene concentration in LNAPL collected from MW-29, and more than four-fold higher than the retene concentration in LNAPL collected from W-2 (570 mg/kg in W-1 versus 230 mg/kg in MW-29 and 130 mg/kg in W-2). It is also inconsistent with the retene concentrations in these two samples. Considering the known disposal of wood waste on the Site, the anomalous retene concentration may be a result of solubilization of retene from wood waste by the mixture of

**PRIVILEGED AND CONFIDENTIAL  
ATTORNEY-CLIENT COMMUNICATION  
ATTORNEY WORK PRODUCT**

diesel fuel and gasoline, but it could also indicate that the diesel fuel contained in sample W-1 is derived from a source distinctly different from the diesel in LNAPL from MW-29.

Finally, as stated above, the gasoline and diesel in LNAPL collected from MW-29 appears less degraded than the gasoline and diesel in LNAPL collected from W-1. In addition, MW-29 is located at a distance from W-1 and near the upgradient side of the property. It is possible that the gasoline in LNAPL, collected from MW-29, originates from an off-site source.

In conclusion, based on examination of information provided in the NAPL Report, AMEC concludes that:

- 1) LNAPLs from MW-29 and W-1 are derived from sources with lower sulfur concentrations than the source from which LNAPL in W-2 is derived.
- 2) LNAPLs from MW-29 and W-1 consist predominantly of a mixture of weathered diesel and weathered gasoline, while LNAPL from W-2 consists predominantly of diesel fuel with small amounts of gasoline.
- 3) LNAPLs from all three locations contain small amounts of residual range petroleum hydrocarbons, which are likely related to solubilization of asphalt or other high molecular weight petroleum hydrocarbons from soil or fill at the site.
- 4) LNAPL in W-2 is more highly weathered, and therefore, likely older than LNAPLs in MW-29 and W-1.
- 5) LNAPL in W-1 contains two-fold higher levels of retene than LNAPL in MW-29, which may indicate different sources or may be the result of the presence of higher plant matter in the soil in the area in which W-1 is located.
- 6) LNAPL in W-1 contains anomalously high levels of decalins and C1-naphthalenes compared to LNAPL in MW-29, which suggests influence of a distinct source or release.
- 7) Diesel in LNAPL from MW-29 appears to be less highly weathered than the diesel in LNAPL from W-1, and LNAPL from MW-29 also contains more gasoline than LNAPL from W-1.

Chromatographic patterns, relative sulfur abundances, and PAH analyses all point to similarities between LNAPL collected from MW-29 and LNAPL collected from W-1, and differences between these LNAPLs and LNAPL collected from W-2. Samples MW-29 and W-1 appear to consist primarily of degraded mixtures of gasoline and diesel with a small residual-range component, while LNAPL collected from W-2 appears to be degraded diesel with trace amounts of gasoline-range and residual-range compounds. The diesel-range analytes in MW-29 and W-1 are similar enough to indicate a common original source, but are different enough to exclude a common release. The diesel-range analytes detected in W-2 are different from both MW-29 and W-1. AMEC was unable to evaluate the gasoline component of LNAPL samples because of a lack of additional analyses of gasoline-range organics.



PRIVILEGED AND CONFIDENTIAL  
ATTORNEY-CLIENT COMMUNICATION  
ATTORNEY WORK PRODUCT

ExxonMobil-Global Remediation  
December 27, 2006

6-914-15716-0  
Page 5

Based on these conclusions and the location of MW-29, distant from W-1 and near the upgradient property boundary, the origin of at least some portion of LNAPL in MW-29 from a source distinct from W-1 cannot be ruled out. If viable third-party sources can be identified in the vicinity of W-1 or W-29, AMEC recommends that Exxon-Mobil/ADC may wish to consider the acquisition of new LNAPL samples from wells at the Site, and analysis of a forensic suite that includes analyses that will yield more information related to the gasoline-range component of LNAPL.

If you have any questions or require further information, please do not hesitate to contact us.

Sincerely,

**AMEC Earth & Environmental, Inc.**

Sean Gormley, EAC, CHMM Chemist  
sea.gormley@amec.com  
Senior Associate/Environmental Chemist

Meg Strong  
meg.strong@amec.com  
L.G. Senior Technical Manager

cc: William Joyce, Salter Joyce Ziker PLLC  
Diana Martin, Bingham McCutchen, LLP

FRIEDMAN & BRUYA, INC.

ENVIRONMENTAL CHEMISTS

Andrew John Friedman  
James E. Bruya, Ph.D.  
(206) 285-5282

3012 16th Avenue West  
Seattle, WA 98119-2029  
FAX: (206) 283-5044

November 27, 1995

Tim Peter, Project Leader  
AGRA Earth & Environmental, Inc.  
11335 NE 122nd Way, Suite 100  
Kirkland, WA 98034-6918

Dear Mr. Peter:

Enclosed are the results from the testing of material submitted on November 22, 1995 from your 11-04658-07 project.

Samples MW-30 and MW-29 contained a heavy fuel oil such as Bunker C, or alternatively, a weathered crude oil. The two samples were very similar, and could easily be from the same source. Sample B-1 contained a heavily weathered Diesel fuel or heating oil. B-1 did not contain the high boiling fraction seen MW-29 and MW-30.

Sample Manhole appeared to contain the water soluble fraction of a middle or heavy petroleum distillate. The GC/FID trace showed patterns of C<sub>3</sub>-benzenes, naphthalene, methylnaphthalenes, and dimethylnaphthalenes. These components tend to be the more water soluble fraction of middle and heavy distillates. A small amount of whole product may also be present, but the water soluble compounds dominate the GC/FID trace.

MW-29, MW-30 and B-1 may have all been sources to Manhole. It is also possible that Manhole has an entirely different source, origin unknown.

We appreciate this opportunity to be of service to you and hope you will call if you should have any questions.

Sincerely,

FRIEDMAN & BRUYA, INC.

*Beth Albertson*

Beth Albertson  
Chemist

keh  
Enclosures  
FAX: 821-3914  
AEE127R.D00

Date of Report: November 27, 1995

Date Received: November 22, 1995

Project: 11-04588-07

Date Samples Extracted: November 24, 1995

**RESULTS FROM THE ANALYSIS OF PRODUCT SAMPLES  
FOR FINGERPRINT CHARACTERIZATION  
BY CAPILLARY GAS CHROMATOGRAPHY  
USING A FLAME IONIZATION DETECTOR (FID)  
AND ELECTRON CAPTURE DETECTOR (ECD)**

**Sample ID**

**B-1**

**GC Characterization**

The GC trace using the flame ionization detector (FID) showed the presence of medium boiling compounds. The patterns displayed by these peaks are indicative of diesel fuel or heating oil.

The medium boiling compounds appeared as a pattern of peaks eluting from  $n-C_6$  to  $n-C_{24}$  showing a maximum near  $n-C_{17}$ . The material appears to have undergone chemical/biological degradation due to the presence of a broad unresolved hump of peaks and to the loss of the  $n$ -alkane peaks.

The large peak seen near 25 minutes on the GC/FID trace is pentacosane, added as a quality assurance check for this GC analysis. There is a second internal standard peak seen on the GC/ECD trace at about 26 minutes which is dibutyl chlorodate.

**MW-30**

The GC trace using the flame ionization detector (FID) showed the presence of low, medium and high boiling compounds. The patterns displayed by these peaks are indicative of a heavy fuel oil such as Bunker C or a crude oil.

The low, medium and high boiling compounds appeared as a ragged pattern of peaks eluting from  $n-C_6$  to  $n-C_{34}$  showing a maximum near  $n-C_{17}$ . A lack of a dominant pattern of  $n$ -alkanes was seen.  $n$ -Alkanes are preferentially consumed by microorganisms, and a lack of  $n$ -alkanes may be correlated to biological weathering.

The large peak seen near 25 minutes on the GC/FID trace is pentacosane, added as a quality assurance check for this GC analysis. There is a second internal standard peak seen on the GC/ECD trace at about 26 minutes which is dibutyl chlorodate.

FRIEDMAN & BRUYA, INC.

ENVIRONMENTAL CHEMISTS

Date of Report: November 27, 1995  
Date Received: November 22, 1995  
Project: 11-04558-07  
Date Samples Extracted: November 24, 1995

RESULTS FROM THE ANALYSIS OF PRODUCT SAMPLES  
FOR FINGERPRINT CHARACTERIZATION  
BY CAPILLARY GAS CHROMATOGRAPHY  
USING A FLAME IONIZATION DETECTOR (FID)  
AND ELECTRON CAPTURE DETECTOR (ECD)

Sample ID

MW-29

GC Characterization

The GC trace using the flame ionization detector (FID) showed the presence of low, medium and high boiling compounds. The patterns displayed by these peaks are indicative of a heavy fuel oil such as Bunker C or a crude oil.

The low, medium and high boiling compounds appeared as a ragged pattern of peaks eluting from  $n$ -C<sub>6</sub> to  $n$ -C<sub>34</sub> showing a maximum near  $n$ -C<sub>17</sub>. A lack of a dominant pattern of  $n$ -alkanes was seen.  $n$ -Alkanes are preferentially consumed by microorganisms, and a lack of  $n$ -alkanes may be correlated to biological weathering. The material present is very similar, though not identical, to the product in MW-30.

The large peak seen near 25 minutes on the GC/FID trace is pentacosane, added as a quality assurance check for this GC analysis. There is a second internal standard peak seen on the GC/ECD trace at about 26 minutes which is dibutyl chlorodate.

Date of Report: November 27, 1995  
Date Received: November 22, 1995  
Project: 11-04558-07  
Date Samples Extracted: November 24, 1995

**RESULTS FROM THE ANALYSIS OF WATER SAMPLES  
FOR FINGERPRINT CHARACTERIZATION  
BY CAPILLARY GAS CHROMATOGRAPHY  
USING A FLAME IONIZATION DETECTOR (FID)  
AND ELECTRON CAPTURE DETECTOR (ECD)**

Sample ID

Manhole

GC Characterization

The GC trace using the flame ionization detector (FID) showed the presence of medium boiling compounds. The patterns displayed by these peaks are indicative of the water soluble fraction of a petroleum product.

The medium boiling compounds appeared as a ragged pattern of peaks eluting from *n*-C<sub>6</sub> to *n*-C<sub>23</sub> on the GC/FID trace. An irregular pattern of *n*-alkanes is seen from *n*-C<sub>11</sub> to *n*-C<sub>19</sub>. *n*-Alkanes have poor solubility in water. It is possible that small amounts of whole product are mixed into the water phase. The major peaks seen between eight and fourteen minutes are likely to be alkylated benzenes, naphthalene, and alkylated naphthalenes. These compounds typically dominate the water soluble fraction of diesels and heavy heating oils. The material present was seen in low concentration, making product identification tentative. The detection limit for this analysis is 200, 400 and 800 ppb (µg/L) for gasoline, diesel and motor oil, respectively.

The large peak seen near 25 minutes on the GC/FID trace is pentacosane, added as a quality assurance check for this GC analysis. There is a second internal standard peak seen on the GC/ECD trace at about 26 minutes which is dibutyl chlorodate.

NRW-1

The GC trace using the flame ionization detector (FID) and the GC electron capture detector (ECD) trace showed an absence of volatile and semi-volatile compounds. The detection limit for this analysis is 500, 1,000, and 2,000 ppb (µg/L) for gasoline, diesel and motor oil, respectively.

AGRA Earth & Environmental  
 11336 NE 122nd Way, #100  
 Kirkland, WA 98034  
 Attention: Tim Peter

Client Project ID: Mobil Everett  
 Sample Matrix: Water  
 Analysis Method: WTPH-G  
 First Sample #: B511431-02

Sampled: Nov 21, 1996  
 Received: Nov 22, 1996  
 Analyzed: Nov 26-27, 1996  
 Reported: Nov 27, 1996

## TOTAL PETROLEUM HYDROCARBONS-GASOLINE RANGE

Sample Number	Sample Description	Sample Result µg/L (ppb)	Surrogate Recovery %
B511431-02	MW-31	N.D.	80
B511431-03	MW-33	N.D.	80
B511431-04	MW-36	N.D.	80
B511431-05	MW-32	N.D.	84
B511431-06	MW-8	N.D.	85
B511431-07	MW-16	N.D.	86
B511431-08	B-2	N.D.	88
B511431-09	MW-18	4,800	S-2
B511431-10	MW-17	N.D.	82
B511431-11	MW-18	4,000 G-1	8-2

Reporting Limit:

50

4-Bromofluorobenzene surrogate recovery control limits are 50 - 150 %.  
 Volatile Total Petroleum Hydrocarbons are quantitated as Gasoline Range Organics (toluene - dodecane).  
 Analytes reported as N.D. were not detected above the stated Reporting Limit.

NORTH CREEK ANALYTICAL Inc.

Please Note:

S-2 = The Surrogate Recovery for this sample cannot be accurately quantified due to interference from coeluting organic compounds present in the sample.

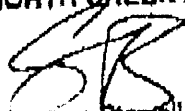
  
 Stowell  
 Project Manager



AGRA Earth & Environmental  
 11936 NE 122nd Way, #100  
 Kirkland, WA 98034  
 Attention: Tim Peter

Client Project ID: Mobil Everett  
 Sample Matrix: Water  
 Analysis Method: WTPH-G  
 First Sample #: B511431-12

Sampled: Nov 21, 1995  
 Received: Nov 22, 1995  
 Analyzed: Nov 26-27, 1995  
 Reported: Nov 27, 1995

## TOTAL PETROLEUM HYDROCARBONS-GASOLINE RANGE

Sample Number	Sample Description	Sample Result µg/L (ppb)	Surrogate Recovery %
B511431-12	MW-8	110	105
B511431-13	MW-9	N.D.	88
B511431-14	MW-27	160 G-1	92
B511431-15	MW-28	N.D.	85
B511431-16	MW-10 11/22/95	1,300	S-2
B611431-17	MW-11 11/22/95	790	S-2
B511431-18	MW-12 11/22/95	N.D.	83
B511431-18	MW-15 11/22/95	120	95
B511431-20	MW-35 11/22/95	N.D.	77
B511431-21	MW-37	N.D.	70

Reporting Limit: 50

4-Bromofluorobenzene surrogate recovery control limits are 50 - 150 %.  
 Volatile Total Petroleum Hydrocarbons are quantitated as Gasoline Range Organics (toluene - dodecane).  
 Analytes reported as N.D. were not detected above the stated Reporting Limit.

NORTH CREEK ANALYTICAL Inc.

Please Note:  
 S-2 - The Surrogate Recovery for this sample cannot be accurately quantified due to interference from coeluting organic compounds present in the sample.

  
 Shannon Stowell  
 Project Manager

511431.AGR <4>

AGRA Earth & Environmental  
11335 NE 122nd Way, #100  
Kirkland, WA 98034  
Attention: Tim Peter

Client Project ID: Mobil Everett  
Sample Matrix: Method Blank  
Analysis Method: WTPH-G  
First Sample #: BLK112695

Analyzed: Nov 26-27, 1995  
Reported: Nov 27, 1995

## TOTAL PETROLEUM HYDROCARBONS-GASOLINE RANGE

Sample Number	Sample Description	Sample Result µg/L (ppb)	Surrogate Recovery %
BLK112695	Method Blank	N.D.	78

Reporting Limit:

50

4-Bromofluorobenzene surrogate recovery control limits are 50 - 150 %.  
Volatile Total Petroleum Hydrocarbons are quantitated as Gasoline Range Organics (toluene - dodecane).  
Analytes reported as N.D. were not detected above the stated Reporting Limit.

NORTH CREEK ANALYTICAL Inc.

  
Shannon Stowell  
Project Manager

011431.AGR -8-

GRA Earth & Environmental  
 1335 NE 122nd Way, #100  
 Kirkland, WA 98034  
 Attention: Tim Peter

Client Project ID: Mobil Everett  
 Sample Matrix: Water  
 Analysis Method: WTPH-G  
 Units: µg/L (ppb)

Analyst: B. Christlieb  
 F. Shino

Analyzed: Nov 26-27, 1995  
 Reported: Nov 27, 1995

## HYDROCARBON QUALITY CONTROL DATA REPORT

### ACCURACY ASSESSMENT Laboratory Control Sample

Gasoline

Spike Conc. Added:	100
Spike Result:	95
% Recovery:	95
Upper Control Limit %:	132
Lower Control Limit %:	58

### PRECISION ASSESSMENT Sample Duplicate

Gasoline Range  
 Organics

Sample Number:	B511431-10	B511431-18
Original Result:	N.D.	N.D.
Duplicate Result:	N.D.	N.D.
Relative % Difference:	Relative Percent Difference values are not reported at sample concentration levels less than 10 times the Detection Limit.	
Maximum APD:	50	50

NORTH CREEK ANALYTICAL Inc.

$$\% \text{ Recovery} = \frac{\text{Spike Result}}{\text{Spike Concentration Added}} \times 100$$

$$\text{Relative \% Difference} = \frac{\text{Original Result} - \text{Duplicate Result}}{(\text{Original Result} + \text{Duplicate Result}) / 2} \times 100$$

  
 Shannon Stowell  
 Project Manager

B11431 AGR <6>

AGFA Earth & Environmental  
 11335 NE 122nd Way, #100  
 Kirkland, WA 98034  
 Attention: Tim Peter

Client Project ID: Mobil Everett  
 Sample Matrix: Water  
 Analysis Method: EPA 8020  
 First Sample #: B511431-02

Sampled: Nov 21, 1995  
 Received: Nov 22, 1995  
 Analyzed: Nov 26-27, 1995  
 Reported: Nov 27, 1995

## BTEX DISTINCTION

Sample Number	Sample Description	Benzene µg/L (ppb)	Toluene µg/L (ppb)	Ethyl Benzene µg/L (ppb)	Xylenes µg/L (ppb)	Surrogate Recovery %
B511431-02	MW-31	N.D.	N.D.	N.D.	N.D.	76
B511431-03	MW-33	N.D.	N.D.	N.D.	N.D.	74
B511431-04	MW-36	N.D.	N.D.	N.D.	N.D.	73
B511431-05	MW-32	N.D.	N.D.	N.D.	N.D.	78
B511431-06	MW-6	N.D.	N.D.	N.D.	N.D.	78
B511431-07	MW-15	N.D.	N.D.	N.D.	N.D.	80
B511431-08	B-2	0.78	N.D.	N.D.	N.D.	80
B511431-09	MW-16	640	9.8	28	140	127
B511431-10	MW-17	66	0.83	N.D.	N.D.	78
B511431-11	MW-18	170	N.D. (R.L. = 2.0)	5.8	3.7	105

<b>Reporting Limits:</b>	0.50	0.50	0.50	1.0
--------------------------	------	------	------	-----

4-Bromofluorobenzene surrogate recovery control limits are 59 - 144 %.  
 Analytes reported as N.D. were not detected above the stated Reporting Limit.

NORTH CREEK ANALYTICAL Inc.

  
 Shannon Stowell  
 Project Manager

AGRA Earth & Environmental  
 11395 NE 122nd Way, #100  
 Kirkland, WA 98034  
 Attention: Tim Pater

Client Project ID: Mobil Everett  
 Sample Matrix: Water  
 Analysis Method: EPA 8020  
 First Sample #: B511431-12

Sampled: Nov 21, 1995  
 Received: Nov 22, 1995  
 Analyzed: Nov 26-27, 1995  
 Reported: Nov 27, 1995

## BTEX DISTINCTION

Sample Number	Sample Description	Benzene µg/L (ppb)	Toluene µg/L (ppb)	Ethyl Benzene µg/L (ppb)	Xylenes µg/L (ppb)	Surrogate Recovery %
B511431-12	MW-8	7.7	N.D.	N.D.	N.D.	88
B511431-13	MW-9	1.3	N.D.	N.D.	N.D.	79
B511431-14	MW-27	N.D.	N.D.	N.D.	N.D.	83
B511431-15	MW-28	N.D.	N.D.	N.D.	N.D.	79
B511431-16	MW-10 11/22/95	1.3	N.D.	N.D.	2.0	5-2
B511431-17	MW-11 11/22/95	36	0.80	1.8	1.6	109
B511431-18	MW-12 11/22/95	9.2	N.D.	N.D.	1.0	77
B511431-19	MW-13 11/22/95	5.2	N.D.	N.D.	N.D.	88
B511431-20	MW-35 11/22/95	2.7	N.D.	N.D.	1.7	74
B511431-21	MW-37	0.50	N.D.	N.D.	N.D.	89

<b>Reporting Limits:</b>	0.50	0.50	0.50	1.0
--------------------------	------	------	------	-----

4-Bromofluorobenzene surrogate recovery control limits are 50 - 142%.  
 Analytes reported as N.D. were not detected above the stated Limit.

NORTH CREEK ANALYTICAL Inc.

  
 Shannon Stowell  
 Project Manager

Please Note:  
 5-2 - The Surrogate Recovery for this sample cannot be accurately quantified due to interference from co-eluting organics present in the sample.

AGRA Earth & Environmental  
 11336 NE 122nd Way, #100  
 Kirkland, WA 98034  
 Attention: Tim Peter

Client Project ID: Mobil Everett  
 Sample Matrix: Water  
 Analysis Method: EPA 8020  
 Units: µg/L (ppb)  
 QC Sample #: B511431-02

Analyst: B. Christlieb  
 F. Shino  
 Analyzed: Nov 26, 1995  
 Reported: Nov 27, 1995

## MATRIX SPIKE QUALITY CONTROL DATA REPORT

ANALYTE	Matrix Spike Quality Control Data			
	Benzene	Toluene	Ethyl Benzene	Xylenes
Sample Result:	N.D.	N.O.	N.D.	N.D.
Spike Conc. Added:	10.0	10.0	10.0	30.0
Spike Result:	9.7	9.5	9.9	31.4
Spike % Recovery:	97%	95%	99%	105%
Spike Dup. Result:	9.4	9.83	9.6	30.5
Spike Duplicate % Recovery:	94%	98%	96%	102%
Upper Control Limit %:	115	110	122	122
Lower Control Limit %:	82	81	85	85
Relative % Difference:	3.1%	1.4%	3.1%	2.9%
Maximum RPD:	16	16	16	17

NORTH CREEK ANALYTICAL  
  
 Shannon  
 Project Manager

$$\text{Relative \% Difference} = \frac{\text{Spike Result} - \text{Sample Result}}{\text{Spike Conc. Added}} \times 100$$

$$\text{Relative \% Difference} = \frac{\text{Spike Result} - \text{Spike Dup. Result}}{(\text{Spike Result} + \text{Spike Dup. Result}) / 2} \times 100$$

AGRA Earth & Environmental  
 11335 NE 122nd Way, #100  
 Kirkland, WA 98034  
 Attention: Tim Peter

Client Project ID: Mobil Everett  
 Sample Matrix: Water  
 Analysis Method: WTPH-D Extended  
 First Sample #: B511431-02

Sampled: Nov 21, 1995  
 Received: Nov 22, 1995  
 Extracted: Nov 22-26, 1995  
 Analyzed: Nov 26-27, 1995  
 Reported: Nov 27, 1995

## TOTAL PETROLEUM HYDROCARBONS - DIESEL RANGE EXTENDED

Sample Number	Sample Description	Diesel Result mg/L (ppm)	Heavy Oil Result mg/L (ppm)	Surrogate Recovery %
B511431-02	MW-31	0.47	N.D.	79
B511431-03	MW-33	0.79	N.D.	81
B511431-04	MW-36	0.71	N.D.	76
B511431-05	MW-32	0.40	N.D.	78
B511431-06	MW-8	0.80	1.4	72
B511431-07	MW-16	0.77	1.2	74
B511431-08	B-2	4.4	3.9	80
B511431-09	MW-15 D-1	1.7	1.7	83
B511431-10	MW-17	0.49	0.97	81
B511431-11	MW-18	1.6	4.4	111

<b>Reporting Limit:</b>	<b>0.25</b>	<b>0.75</b>
-------------------------	-------------	-------------

2-Fluorobiphenyl surrogate recovery control limits are 50 - 150%.  
 Extractable Hydrocarbons are quantitated as Diesel Range Organics (C12 - C24) and Heavy Oil Range Organics (>C24).  
 Analytes reported as N.D. were not detected above the stated Reporting Limit.

NORTH CREEK ANALYTICAL Inc.

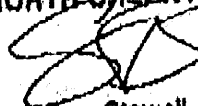
  
 Shannon Stowell  
 Project Manager

AGRA Earth & Environmental  
 11335 NE 122nd Way, #100  
 Kirkland, WA 98034  
 Attention: Tim Peter

Client Project ID: Mobil Everett  
 Sample Matrix: Water  
 Analysis Method: WTPH-D Extended  
 First Sample #: B511431-12

Sampled: Nov 21, 1995  
 Received: Nov 22, 1995  
 Extracted: Nov 22-26, 1995  
 Analyzed: Nov 26-27, 1995  
 Reported: Nov 27, 1995

## TOTAL PETROLEUM HYDROCARBONS - DIESEL RANGE EXTENDED

Sample Number	Sample Description	Diesel Result mg/L (ppm)	Heavy Oil Result mg/L (ppm)	Surrogate Recovery %
B511431-12	MW-8	3.3	3.1	91
B511431-13	MW-9	3.3	3.3	90
B511431-14	MW-27	4.7	4.4	98
B511431-15	MW-28	3.4	3.7	94
B511431-16	MW-10 11/22/95	4.2	6.0	84
B511431-17	MW-11 11/22/95	2.4	1.2	93
B511431-18	MW-12 11/22/95	2.1	3.6	84
B511431-19	MW-13 11/22/95	6.7	3.1	98
B511431-20	MW-38 11/22/95	0.33	1.1	93
B511431-21	MW-37	1.6	2.4	84

Reporting Limit:

0.25

0.75

2-Fluorobiphenyl surrogate recovery control limits are 80 - 150%.  
 Extractable Hydrocarbons are quantitated as Diesel Range Organics (C12 - C24) and Heavy Oil Range Organics (>C24).  
 Analytes reported as N.D. were not detected above the stated Reporting Limit.

NORTH CREEK ANALYTICAL Inc.

  
 Shannon Stowell  
 Project Manager



IRA Earth & Environmental  
 335 NE 122nd Way, #100  
 Portland, WA 98034  
 Attention: Tim Peter

Client Project ID: Mobil Everett  
 Sample Matrix: Method Blank  
 Analysis Method: WTPH-D Extended  
 First Sample #: BLK112295

Sampled: Nov 22, 1995  
 Received: Nov 22, 1995  
 Extracted: Nov 22-26, 1995  
 Analyzed: Nov 26-27, 1995  
 Reported: Nov 27, 1995

## TOTAL PETROLEUM HYDROCARBONS - DIESEL RANGE EXTENDED

Sample Number	Sample Description	Diesel Result mg/L (ppm)	Heavy Oil Result mg/L (ppm)	Surrogate Recovery %
BLK112295	Method Blank	N.D.	N.D.	84
BLK112695	Method Blank	N.D.	N.D.	85

Reporting Limit:

0.25

0.75

2-Fluorobiphenyl surrogate recovery control limits are 50 - 150%.  
 Extractable Hydrocarbons are quantitated as Diesel Range Organics (C12 - C24) and Heavy Oil Range Organics (>C24).  
 Analytes reported as N.D. were not detected above the stated Reporting Limit.

NORTH CREEK ANALYTICAL Inc.

  
 Shannon Stowell  
 Project Manager

AGRA Earth & Environmental  
 11335 NE 122nd Way, #100  
 Kirkland, WA 98034  
 Attention: Tim Peter

Client Project ID: Mobil Everett  
 Sample Matrix: Water  
 Analysis Method: WTPH-D  
 Units: mg/L (ppm)

Analyst: T. Fitzgibbon  
 Extracted: Nov 22, 1995  
 Analyzed: Nov 26-27, 1995  
 Reported: Nov 27, 1995

## HYDROCARBON QUALITY CONTROL DATA REPORT

### ACCURACY ASSESSMENT Laboratory Control Sample

Diesel

Spike Conc. Added: 2.04  
 Spike Result: 1.91  
 % Recovery: 94  
 Upper Control Limit %: 107  
 Lower Control Limit %: 69

### PRECISION ASSESSMENT

#### Sample Duplicate

Diesel Range Organics	Diesel Range Organics
B511431-09	B511398-02
Original Result: 1.7	1.9
Duplicate Result: 1.4	2.2
Maximum RPD: 44	44

Relative % Difference: Relative Percent Difference values are not reported at sample concentration levels less than 10 times the Reporting Limit.

Maximum RPD: 44

NORTH CREEK ANALYTICAL Inc.

% Recovery:

$$\frac{\text{Spike Result}}{\text{Spike Concentration Added}} \times 100$$

Relative % Difference:

$$\frac{\text{Original Result} - \text{Duplicate Result}}{(\text{Original Result} + \text{Duplicate Result}) / 2} \times 100$$

Shannon Stowell  
 Project Manager

IGRA Earth & Environmental  
 1335 NE 122nd Way, #100  
 Kirkland, WA 98034  
 Attention: Tim Peter

Client Project ID: Mobil Everett  
 Sample Matrix: Water  
 Analysis Method: WTPH-D  
 Units: mg/L (ppm)

Analyst: T. Fitzgibbon  
 Extracted: Nov 26, 1995  
 Analyzed: Nov 28-27, 1995  
 Reported: Nov 27, 1995

## HYDROCARBON QUALITY CONTROL DATA REPORT

### ACCURACY ASSESSMENT Laboratory Control Sample

Diesel

Spike Conc. Added: 2.04

Spike Result: 1.61

% Recovery: 79

Upper Control Limit %: 107

Lower Control Limit %: 69

### PRECISION ASSESSMENT

Sample Duplicate

Diesel Range Organics

Sample Number: B511431-19

Original Result: 6.7

Duplicate Result: 5.7

Relative % Difference: 16

Maximum RPD: 44

NORTH CREEK ANALYTICAL Inc.

  
 Shannon Stowell  
 Project Manager

% Recovery:  $\frac{\text{Spike Result}}{\text{Spike Concentration Added}} \times 100$   
 Relative % Difference:  $\frac{\text{Original Result} - \text{Duplicate Result}}{(\text{Original Result} + \text{Duplicate Result}) / 2} \times 100$

## HYDROCARBON ANALYSIS FOOTNOTES

2/94, Rev. 3

### VOLATILE HYDROCARBONS - GASOLINE RANGE ORGANICS

- G 1 This sample appears to contain extractable diesel range organics.
- G 2 The chromatogram for this sample does not resemble a typical gasoline pattern. Please refer to the sample chromatogram.
- G 3 The total hydrocarbon result on this sample is primarily due to an individual compound(s) eluting in the volatile hydrocarbon range. Identification and quantitation by EPA 8010, 8021 or 8240 is recommended.
- G 4 This sample contains compound(s) not identified as Benzene, Toluene, Ethyl benzene or Xylene.
- G 5 This sample appears to contain or be saturated with gasoline product.

### EXTRACTABLE HYDROCARBONS - DIESEL RANGE ORGANICS

- D 1 This sample appears to contain volatile gasoline range organics.
- D 2 The hydrocarbons present in this sample resemble heavy, non-resolvable oil range organics. Quantitation by TPH-Diesel Extended or TPH 418.1 is recommended.
- D 3 The hydrocarbon concentration result in this sample is partially due to an individual peak(s) eluting in the diesel / motor oil carbon range.
- D 4 The hydrocarbons present in this sample are a complex mixture of diesel range and heavy oil range organics.
- D 5 The hydrocarbon result shown is an estimated (greater than) value due to the high concentration. Reanalysis is being performed to yield a quantitative result. An amended report will follow.
- D 6 The sample chromatographic pattern does not resemble the fuel standard used for quantitation. A fuel fingerprint is advised.
- D 7 This sample appears to contain or be saturated with diesel product.

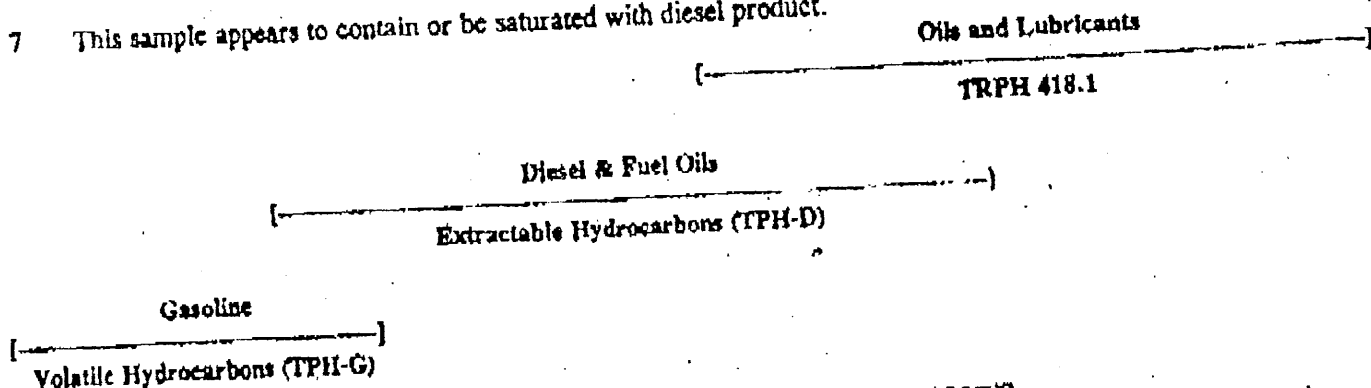

### HYDROCARBON BOILING POINT RANGE

LOW      LOW TO MEDIUM      MEDIUM      MEDIUM TO HIGH      VERY HIGH

### CARBON RANGE:

6 7 8 9 10 11 12 13 14 15 16 17 18 19 20 21 22 23 24 25 26 27 28 29 30 31+

**OIL SAMPLE ANALYSIS REPORT**  
**MARINE SAFETY OFFICE PUGET SOUND**  
**CASE NUMBER MC95015622**  
**MARINE SAFETY LABORATORY**  
**CASE NUMBER 96-013**

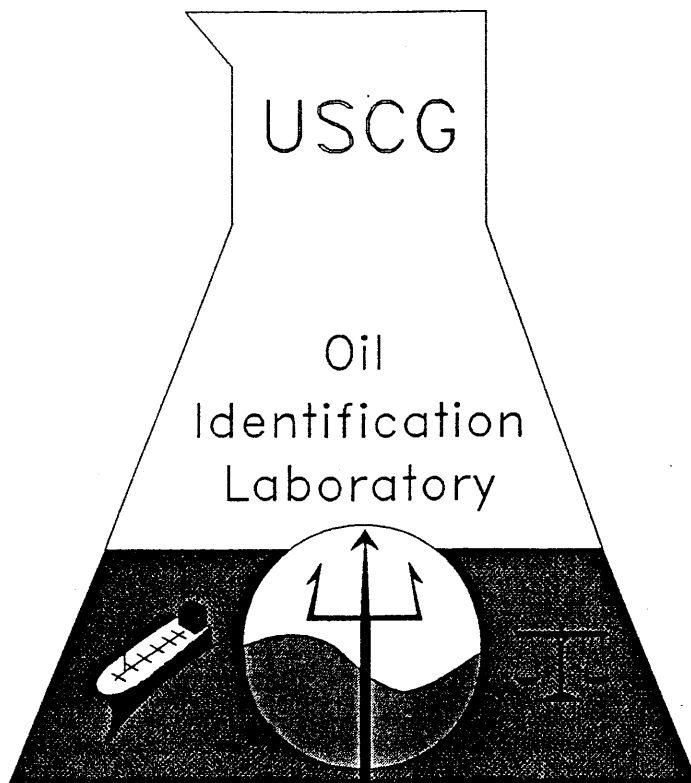

U.S. Department  
of Transportation

United States  
Coast Guard



Commanding Officer  
U. S. Coast Guard  
Marine Safety  
Laboratories

1082 Shennecossett Road  
Groton, CT 06340-6094  
Phone: (860) 441-2645  
Fax: (860) 441-2641

16400

OCT 18 1995

From: Commanding Officer, Marine Safety Laboratories  
To: Commanding Officer, Marine Safety Office Puget Sound

Subj: OIL SAMPLE ANALYSIS REPORT, MSO PUGET SOUND CASE# MC95015622  
MSL CASE #96-013

1. The laboratory analysis of this case has been completed and our report is forwarded. The technical data supporting the report (spectrograms and chromatograms) have been archived at our facility and are available upon request. We will maintain the oil samples in refrigerated storage pending final case disposition.

2. Questions concerning this report or the analytical methods used should be directed to the Supervisor of Analysis, Dr. Hendrick.

*Margaret Hendrick*

M. S. HENDRICK  
By direction

Encl: (1) MSL Report 96-013  
(2) OIS Addendum

UNITED STATES COAST GUARD  
OIL IDENTIFICATION LABORATORY

OIL SPILL IDENTIFICATION REPORT

LABORATORY CASE NUMBER: 96-013

REQUESTOR: MSO PUGET SOUND  
UNIT CASE NUMBER: MC95015622  
RECEIVED: 16OCT95 VIA: U.S. MAIL

NUMBER OF SAMPLES: TEN (10)  
LAB NO. OF SPILLS: 1,2,5,6 AND 7  
LAB NO. OF SUSPECTS: 3,4,8,9 AND 10

ANALYSIS METHODS:

GAS CHROMATOGRAPHY (GC)  
GAS CHROMATOGRAPHY/MASS SPECTROMETRY (GC/MS)

RESULTS:

1. Samples 1,2,5,6 and 7 were specified to have been representative of spilled oil. Analysis indicates:

a. Samples 1,2,5 and 6 are similar and contain a severely biodegraded and evaporatively weathered heavy fuel oil mixed with lubricating oil.

b. Sample 7 contains only traces of a severely biodegraded heavy fuel oil mixed with lubricating oil. The characteristics of sample 7 are similar to those expected for a severely weathered version of samples 1,2,5 and 6.

2. Suspected source sample 8 is observed to contain a heavy fuel oil with characteristics similar to those of the heavy fuel oil component of the spilled oil. Most differences are consistent with biodegradative and evaporative weathering of the spilled oil; However, this sample contains no lubricating oil.

3. Suspected source samples 3 and 4 are observed to contain biodegraded light fuel oil with characteristics different from those of the spilled oil.

4. Suspected source samples 9 and 10 are observed to contain mixtures of fuel oil and lubricating oil with characteristics different from those of the spilled oil.

CONCLUSIONS:

1. Spill samples 1,2,5,6 and 7 represent different portions of the same spilled oil.

2. The heavy fuel oil in suspected source sample 8 and the spill samples 1,2,5,6 and 7 may be derived from a common source. Biodegradation, as noted in the spilled oil samples, is characteristic of oil that has been retained in a contaminated

CONTINUATION OF OIL SPILL IDENTIFICATION REPORT 96-013

environment for an extended period of time. Not all differences noted are consistent with biodegradative weathering of the spilled oil. It should be noted that lubricating oil contamination is very common in sewers. For this reason, the area in proximity to the location from which sample 8 was collected should be investigated further as the most likely source of the spilled oil.

3. None of suspected source samples 3,4,9 or 10 are derived from a common source of the spill samples 1,2,5 and 6.

*Martha S. Hendrick*

SUPERVISOR OF ANALYSIS M. S. HENDRICK, Ph.D. DATE: 18OCT95  
Chemist



11/89

UNITED STATES COAST GUARD  
OIL IDENTIFICATION LABORATORY

SAMPLE CHECK-IN LOG, COIL CASE NUMBER: 96-013

REQUESTOR: MSO PUGET SOUND UNIT CASE# MC95015622

		METHOD OF DELIVERY		DATE RECEIVED
US MAIL		MESSENGER	OTHER	
NUMBER	DATE MAILED O/A			
N/A	11 OCT 95			16 OCT 95

Samples were observed to be: broken NO, tampered with NO, leaking NO, or subject to contamination NO. For these and other unusual conditions, place an asterisk (\*) next to the sample(s) in question and describe condition of sample(s) in remarks below.

LAB NO.	SAMPLE DESCRIPTION	SPILL	SUSPECT
96-013-1	[1] OIL FROM PIPE OF SEWER OUTFALL AT BREAK WALL 02 OCT 95 0845	XXXXX	
96-013-2	[2] SAMPLE OF FUEL IN THE WATER 02 OCT 95 0850	XXXXX	
96-013-3	[3] POSSIBLE SOURCE FROM HOLE IN GROUND AT AMERICAN DISTRIBUTING 02 OCT 95 1010		XXXXX
96-013-4	[4] POSSIBLE SOURCE AMERICAN DISTRIBUTING HOLE IN GROUND 02 OCT 95 1012		XXXXX
96-013-5	[5] DRAIN LINE IN YARD DOCK. BY FENCE LINE IN LOG YARD 05 OCT 95 1155	XXXXX	
96-013-6	[6] SEWER OUTFALL IN YARD DOCK BY FENCE LINE IN LOG YARD 05 OCT 95 1200	XXXXX	
96-013-7	[7] SEWER OUTFALL UNDER LOG ROLE IN LOG YARD 02 OCT 95 1615	XXXXX	
96-013-8	[8] POSSIBLE SOURCE OF BLACK OIL IN PIPE IN IN GARAGE OLD ENGINE ROOM 05 OCT 95 1210		XXXXX
96-013-9	[9] BILGE SIDE OF TANK AT DUNLAP TOWING 05 OCT 95 1233		XXXXX
96-013-10	[10] BILGE TANK OF POSSIBLE SOURCE OF TANK DUNLAP TOWING 05 OCT 95 1233		XXXXX

REMARKS:

Samples checked-in by: [Signature] Date: 16 OCT 95

Sample Custodian: [Signature] Date: 16 OCT 95

Supervisor of Analysis: Martha Hendrick Date: 17 Oct 95

11 OCT 95  
Date

From: COMMANDING OFFICER, MARINE SAFETY OFFICE PUGET SOUND  
To: Commanding Officer, Marine Safety Laboratories

Subj: REQUEST FOR OIL SAMPLE ANALYSIS

1. Request analysis of the  samples listed on attached Chain of Custody Record to assist in our investigation of spill case  
FPN 13-6001 MC95015622  
(Federal Project Number and Marine Casualty "MC" number)

2. Questions concerning this case should be directed to  
Bmt CHRIS P. SCARBERRY COMMERCIAL# 206-217-6232

3. The spill samples were collected from SEWER OUTFALL FACILITY  
SEWER DRAIN AND BAY  
(river, outfall, shore, etc)

4. Estimated number of gallons spilled 50; Estimated cost of cleanup \$3,000.

5. Wind conditions: \_\_\_ mild breeze; \_\_\_ Very Windy;  Calm.

6. Air Temperature: \_\_\_ below 32F;  32 to 60F; \_\_\_ 60 to 85F  
\_\_\_ 85 to 95F; \_\_\_ over 95F.

7. Sky conditions:  Overcast; \_\_\_ Bright Sun; \_\_\_ Rain;  
Other (specify) \_\_\_\_\_

8. Spill involves seepage of oil through the soil: \_\_\_ Yes  No.  
If Yes, estimated distance to the nearest possible suspected source:  
\_\_\_\_\_

9. List any possible non-petroleum contamination sources in the area NONE

10. Are all samples involved in this case being sent to the laboratory? YES If not, explain \_\_\_\_\_

11. Have all possible suspect sources been sampled,  If NO, include a detailed explanation of possible sources not sampled. Provide any additional information about the samples or overall situation which may be helpful to lab personnel: \_\_\_\_\_

12. Specify prosecution type:  Class 1; \_\_\_ Class 2; \_\_\_ DOJ.

(SIGNATURE)

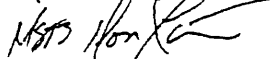

**UNITED STATES COAST GUARD  
CHAIN OF CUSTODY RECORD**

COMMANDING OFFICER

(UNIT AND ADDRESS)

U.S. COAST GUARD  
MARINE SAFETY OFFICE  
PUGET SOUND  
1519 ALASKAN WAY SOUTH  
SEATTLE, WA. 98134-1192

SPILL	SOURCE	SAMPLE NO.	DESCRIPTION OF SAMPLES FOR CASE# <u>MC95015622</u>
XXX		1	OIL FROM PIPE OF SEWER OUTFALL AT BREAKWALL
XXX		2	SAMPLE OF FUEL IN THE WATER
	XXX	3	POSSIBLE SOURCE FROM HOLE IN GROUND AT AMERICAN DIS
	XXY	4	POSSIBLE SOURCE FROM AMERICAN DISTRIBUTING HOLE IN GRA
XXX		5	DRAIN LINE IN YARD DOCK BY FENCE LINE. LOG YARD
XXX		6	SEWER OUTFALL IN YARD DOCK BY FENCE LINE. LOG YARD
XXX		7	SEWER OUTFALL UNDER LOG RAKE IN LOG YARD
XXX		8	POSSIBLE SOURCE OF BLACK OIL IN GARAGE OF OLD EMERSON
	XXX	9	BILGE-SIDE OF TANK Dunlap Towing OIL SIDE
	XXX	10	BILGE TANK OF Dunlap Towing Bilge Side

PERSON ASSUMING RESPONSIBILITY FOR SAMPLES					TIME/DATE
SAMPLE NUMBER	RELINQUISHED BY:	DATE/TIME	RECEIVED BY:	DATE/TIME	REASON FOR CHANGE OF CUSTODY
1-10	<i>[Signature]</i> Bm2 G.R. Scanberry	0806LT 1495	<i>[Signature]</i> MST3 LANSURE	02 OCT 95 1700	STORAGE
SAMPLE NUMBER	RELINQUISHED BY:	DATE/TIME	RECEIVED BY:	DATE/TIME	REASON FOR CHANGE OF CUSTODY
1-10	<i>[Signature]</i> MST3 DON LANSURE	11 OCT 95 1430	<i>[Signature]</i> Bm2 G.P. Scanberry	11 OCT 95 1430	Ship to Coil
SAMPLE NUMBER	RELINQUISHED BY:	DATE/TIME	RECEIVED BY:	DATE/TIME	REASON FOR CHANGE OF CUSTODY
1-10	<i>[Signature]</i> Bm2 Scanberry	11 OCT 95 1433	<i>[Signature]</i> TROYER HAMMER MST3 ATMSL	09 30 16 OCT 95	
SAMPLE NUMBER	RELINQUISHED BY:	DATE/TIME	RECEIVED BY:	DATE/TIME	REASON FOR CHANGE OF CUSTODY

**MARINE SAFETY LABORATORIES  
OIL IDENTIFICATION LABORATORY**

**SAMPLE PREPARATION SHEET**

COIL CASE NUMBER: 96-013

DATE PREPARED: 16 OCT 95

Oil samples were obtained using preparation techniques listed below. The samples were then placed into a vial and identified with the COIL case number and sample number along with the corresponding preparation code(s).

Oil samples eliminated by IR screening method: \_\_\_\_\_

The Quality Control sample is a duplicate of sample: 96-013-8

SAMPLE NUMBERS (sequential portion only)	PREPARATION CODE	RATIO
1, 2, 3, 4, 8, 9, 10, 00	2	
5, 6, 7	4, 7	

**PREPARATION CODES**

1. Portion of neat sample taken from sample jar (clean fuel oils).
2. Portion of sample taken from sample jar, anhydrous  $MgSO_4$  added, then centrifuged.
3. Portion of sample taken from sample jar, diluted with cyclohexane, anhydrous  $MgSO_4$  added, then centrifuged.
4. Entire sample extracted with cyclohexane, anhydrous  $MgSO_4$  added, then centrifuged.
5. Entire sample extracted with two separate 10 ml portions of cyclohexane, anhydrous  $MgSO_4$  added to the combined cyclohexane solution, then centrifuged.
6. Cyclohexane Solution: ratio of oil to cyclohexane is known and shown in "ratio" column.
7. Cyclohexane Solution of unknown concentration.
8. Solvent evaporated with heat and a stream of  $N_2$ . Sample of unknown concentration.
9. Others: \_\_\_\_\_

Preparer's Signature: Bruce Altman Date: 16 OCT 95

UNITED STATES COAST GUARD  
MARINE SAFETY LABORATORIES  
OIL IDENTIFICATION LABORATORY

QUALITY CONTROL SHEET

COIL CASE NUMBER: 96-013 DATE PREPARED: 16 OCT 95

1. A Quality Control (QC) sample was analyzed along with the other samples in this case.

X The Quality Control (QC) is a duplicate of sample 96-013-8  
Due to limited sample quantity in all samples involved in the case, reference oil \_\_\_\_\_ from the COIL Library was used for the Quality Control (QC) and it's duplicate sample.  
Infrared Spectroscopy used for screening samples before final sample preparation. No QC sample available during IR screening.

2. ANALYTICAL METHODS.

INFRARED SPECTROSCOPY

GAS CHROMATOGRAPHY

FLUORESCENCE SPECTROSCOPY

GAS CHROMATOGRAPHY/MASS SPECTROMETRY

SAT	N/A
	X
X	
	X
X	

3. The data and conclusions for the QC and it's duplicate were identical:

Yes X No \_\_\_\_\_

COMMENTS:  
\_\_\_\_\_

SUPERVISOR OF ANALYSIS:

Margaret Hendrick

DATE: 18 OCT 95

UNITED STATES COAST GUARD  
MARINE SAFETY LABORATORY

OIL SPILL IDENTIFICATION ANALYSES  
COST RECOVERY DOCUMENTATION

LABORATORY CASE NUMBER: 96-013

REQUESTOR: MARINE SAFETY OFFICE PUGET SOUND

UNIT CASE NUMBER: MC95015622

NUMBER OF SAMPLES: 10

NUMBER OF ANALYSES: 18

COST PER ANALYSIS: \$97.00

TOTAL COSTS: \$1746.00

This documentation is provided for purposes of Phase IV - Documentation and Cost Recovery under the National Oil and Hazardous Substances Pollution Contingency Plan(40 CFR Part 300).

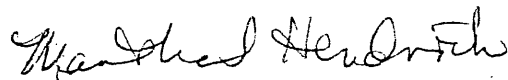

MARTHA S. HENDRICK DATE: 18OCT95  
Chemist

**OIL SPILL IDENTIFICATION SYSTEM (OIS)****RELEVANCE TO SPILL SOURCE DETERMINATION**

Petroleum is a complex mixture of thousands of different organic compounds formed from a variety of organic materials that are chemically converted under differing geological conditions over long periods of time. The infinitely variable nature of these factors results in distinct chemical differences between oils formed under dissimilar conditions and/or environments. While oil from one crude oil field is readily distinguishable from another, differences in the makeup of oils from the same crude oil field can sometimes be observed as well. Refined oils are fractions usually derived by distillation of crude oil. Two refined oils of the same type differ because of dissimilarities in the characteristics of their crude oil feed stocks as well as variations in refinery processes and any subsequent contact with other oils mixed in during transfer operation from residues in tanks, ships, pipes, hoses etc... Thus, all petroleum oils, to some extent have chemical compositions that differ from each other.

The characteristic properties of an oil can be explored by a variety of analytical methods. The results of analysis by any of these methods can be presented in graph form. In general, when the graphical data for two oils produced by a particular method are compared, the differences between the graphs reflect differences between the oils.

The OIS System, developed during the mid-1970s at the Coast Guard Research and Development Center, is based on a multi-method approach to "fingerprinting" oils. In 1978, the Central Oil Identification Laboratory (COIL) was established as the operating facility to implement the OIS. In 1988, COIL was renamed the Marine Safety Laboratories (MSL), though the acronym COIL is still widely used. OIS is designed to determine the unique, intrinsic chemical properties of oils via analytical techniques and establish whether or not a common source relationship exists between samples of spilled oil and samples of oil from a suspected source. Since 1978, MSL/COIL has analyzed over 39,000 samples, involving more than 5,700 spill cases, in support of oil pollution investigations.

**DATA PRODUCTION AND INTERPRETATION**

Oil sample preparation, testing and storage are conducted in accordance with American Society for Testing and Materials (ASTM) consensus standards. MSL/COIL currently utilizes three primary analytical techniques: Gas Chromatography (GC) (ASTM D-3328), Fluorescence Spectroscopy (FL) (ASTM D 3650), Infrared Spectroscopy (IR) (ASTM D-3414), and Gas Chromatography-Mass Spectrometry (GC-MS) (ASTM D-5739) that is used as a complementary analytical method. A rigorous laboratory quality assurance program monitors both instrument performance and sample preparation to ensure that data are accurate and reproducible.

All samples in a given case are initially analyzed by one method to determine the class of petroleum product. Samples can be excluded from further analysis based on results from the initial analysis. Further analyses are performed on samples which are potential matches to the source of the oil.

The Supervisor of Analysis interprets the data from all test methods performed and draws conclusions concerning whether or not certain spilled oil and suspected source samples were derived from the same chemical source. Data interpretation in oil spill source identification is non-trivial and fundamentally different from typical chemical analyses because the chemical properties of spilled oil are altered when oil is introduced into the environment. From the moment oil enters the environment, evaporation, dissolution, photochemical oxidation, biodegradation and other forces begin to alter the oil's characteristics or "fingerprint". These combined processes are termed weathering and can significantly complicate data interpretation. Contamination of the spilled oil with other oils or substances is another complicating factor. The experienced oil spill analyst is familiar with the complexities of the weathering processes and is able to distinguish real differences between two oils from those apparent differences resulting from weathering alterations. Interferences from contaminants can usually be recognized as such and discounted when weighing the test results. However, at times, severe weathering and/or contamination can mask many of the inherent differences between oils of a similar type.

#### REPORTING

The typical MSL/COIL OIS Report consists of four parts: case identifying information, a listing of analysis techniques performed, the results section and the conclusions section. The results section describes the types of petroleum observed in the samples provided, and comments on chemical similarities or dissimilarities between spill samples and/or between spill and suspected source samples. In all cases the Supervisor of Analysis bases the written results on interpretations from the aggregate of all data generated.

The conclusions section establishes whether or not a common source relationship exists between samples of spilled oil and samples of oil from a suspected source. There are two outcomes most frequently found in the conclusions section of the typical MSL/COIL OIS Report: "derived from a common source" and "not derived from a common source". However, to maintain the high degree of reliability for both "common source" and "not a common source" determinations, it is necessary to exclude some comparisons from these categories. Oil spill cases vary widely in possible explanations for why a determination could not be made. Instead of using only a statement of "inconclusive", the comments will concisely explain the reason for the outcome for each individual case. For example, some sources are highly inhomogeneous, and a sample of such a spill may not reflect the composition of the product remaining in such a source. The spill may contain very little oil, or it may be excessively weathered or contaminated. Of important note, MSL/COIL conclusions address chemical comparisons and not physical aspects of evidence. Additionally, chemical evidence provided in a MSL/COIL conclusion that is other than "common source" might still be used by the investigating officer, when combined with physical evidence to establish a preponderance of the evidence argument against an alleged responsible party.



MSL/COIL OIS Reports are submitted to Marine Safety Offices (MSO's) for inclusion, as chemical evidence, in Marine Violation/Casualty Reports. The outcomes in the conclusions section of the OIS Report define the nature of the chemical evidence provided. MSO personnel are advised to combine the chemical evidence provided in the MSL/COIL OIS Reports with physical and circumstantial evidence developed during the investigation when writing Marine Violation Reports. Inquiries challenging the technical content of MSL/COIL OIS Reports by representatives of the alleged responsible party should be handled at the Hearing Officer level. Explicit guidance describing the communications process between the Hearing Officer and the MSL/COIL Supervisor of Analysis on technical issues involving chemical evidence is given in Commandant (G-LMI) memorandum 16460 dated 26 January 1981.

#### PERSONNEL QUALIFICATIONS

MSL/COIL laboratory technicians performing sample preparation and testing are graduates of the Coast Guard Marine Science Technician School. Each MSL/COIL technician has successfully completed a comprehensive training program at the MSL/COIL facility. Additionally, many have received supplemental training at leading civilian institutions in their specialty area.

The Supervisor of Analysis monitors all aspects of the analysis, certifies and interprets the test results, and prepares the final MSL/COIL report. This individual is a professionally trained chemist experienced in oil spill source identification. Individuals currently qualified to perform this function are:

Lieutenant Commander Kristy L. Plourde, U.S. Coast Guard  
Commanding Officer  
B.S. Physical Sciences, 1983, US Coast Guard Academy  
M.S. Chemistry, 1989, University of Connecticut

Dr. Martha Hendrick  
Chemist  
B.A. Chemistry, 1969, Rhodes College  
M.A. Education, 1974, Stanford University  
Ph.D. Analytical Chemistry, 1985, University of Connecticut  
Chair, ASTM Subcommittee D19.31, Waterborne Oils

#### REFERENCES

A more technical description of the OIS is contained in Report CG-D-52-77 "Oil Spill Identification System", Final Report, June 1977, USCG R&D Center. This document is available through the National Technical Information Service, Springfield, VA 22161.

For information concerning the ASTM standards used in Oil Spill Identification, consult "Oil in the Environment", Martha S. Hendrick, Ph.D., ASTM Standardization News, April 1991.

For additional information regarding the applicability of the Coast Guard's OIS, see "Chemical Identification of Oil Spill Sources", Allen P. Bentz, Ph.D., The Forum, Volume XIII, Number 2, Winter 1978. Dr. Bentz is a research scientist at the Coast Guard Research and Development Center and a recognized expert in the field of oil spill source identification. He has been closely involved with most of the development work leading to the present state-of-the-art.

**OIL SAMPLE ANALYSIS REPORT**  
**MARINE SAFETY OFFICE PUGET SOUND**  
**CASE NUMBER MC95015622**  
**MARINE SAFETY LABORATORY**  
**CASE NUMBER 96-097**

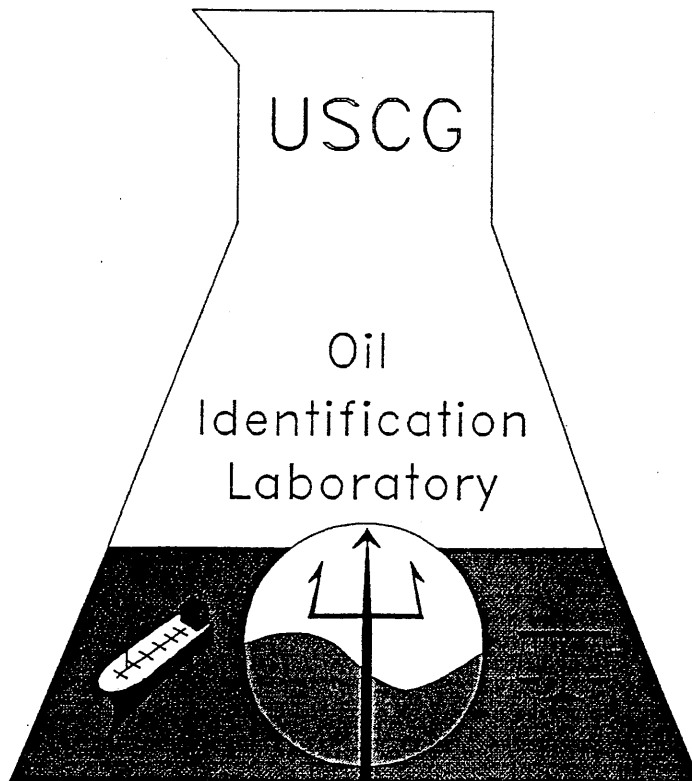

U.S. Department  
of Transportation

United States  
Coast Guard



Commanding Officer  
U. S. Coast Guard  
Marine Safety  
Laboratories

1082 Shennecossett Road  
Groton, CT 06340-6094  
Phone: (860) 441-2645  
Fax: (860) 441-2641

16400

DEC 20 1995

From: Commanding Officer, Marine Safety Laboratories  
To: Commanding Officer, Marine Safety Office Puget Sound  
Subj: OIL SAMPLE ANALYSIS REPORT, MSO PUGET SOUND CASE# MC95015622  
MSL CASE #96-097

1. The laboratory analysis of this case has been completed and our report is forwarded. The technical data supporting the report (spectrograms and chromatograms) have been archived at our facility and are available upon request. We will maintain the oil samples in refrigerated storage pending final case disposition.
2. Questions concerning this report or the analytical methods used should be directed to the Supervisor of Analysis, Dr. Hendrick.

*Manthel Hendrick*

M. S. HENDRICK  
By direction

Encl: (1) MSL Report 96-097  
(2) OIS Addendum

UNITED STATES COAST GUARD MARINE SAFETY LABORATORIES  
OIL IDENTIFICATION LABORATORY

OIL SPILL IDENTIFICATION REPORT

LABORATORY CASE NUMBER: 96-097

REQUESTOR: MSO PUGET SOUND

UNIT CASE NUMBER: MC95015622

RECEIVED: 14DEC95 VIA: CERTIFIED MAIL ( # P 902 422 199)

NUMBER OF SAMPLES: FIVE (05)

LAB NO. OF SPILLS: 3 AND 4

LAB NO. OF SUSPECTS: 1,2 AND 5

ANALYSIS METHODS:

GAS CHROMATOGRAPHY (GC)

GAS CHROMATOGRAPHY/MASS SPECTROMETRY (GC/MS)

SPECIAL INSTRUCTIONS:

1. Compare the samples submitted with spill samples from COIL Case 96-013.

RESULTS:

1. Samples 96-097-3 and 4 were specified to have been representative of spilled oil. Analysis indicates they do not contain a detectable quantity of petroleum oil.

2. Samples 96-013-1,2,5,6 and 7 were specified to have been representative of previously spilled oil. Analysis indicates:

a. Samples 96-013-1,2,5 and 6 are similar and contain a severely biodegraded and evaporatively weathered heavy fuel oil mixed with lubricating oil.

b. Sample 96-013-7 contains only traces of a severely biodegraded heavy fuel oil mixed with lubricating oil. The characteristics of sample 96-013-7 are similar to those expected for a severely weathered version of samples 96-013-1,2,5 and 6.

3. Suspected source sample 96-097-2 is observed to contain a severely biodegraded and evaporatively weathered heavy fuel oil mixed with lubricating oil. The characteristics are similar to those of the heavy fuel oil component of the spilled oil. However, this sample contains significantly less lubricating oil than the spill samples.

4. Suspected source sample 96-097-5 is observed to contain a heavy fuel oil with characteristics different from those of the spilled oil.

5. Suspected source sample 96-097-1 is observed to contain only traces of petroleum oil. Results are of no value for comparison purposes.

*where  
was  
taken from #7*

CONTINUATION OF OIL SPILL IDENTIFICATION REPORT 96-097

CONCLUSIONS:

1. Comparison of spill samples 96-097-3 and 4 is inconclusive because they do not contain a sufficient quantity of petroleum oil for comparison purposes.
2. Suspected source sample 96-097-2 and the spill samples 96-013-1, 2, 5, 6 and 7 are closely related and appear to be derived from common sources of petroleum oil. Sample 96-097-2 appears to represent another portion of spilled oil, rather than the origin of the spill. The difference in the proportion of lubricating oil indicates that more than one source is probably responsible for the problem. Biodegradation, as noted in these oil samples, is characteristic of oil that has been retained in a contaminated environment for an extended period of time. The source from which sample 96-013-8 (previously discussed in case 96-013) was collected is a likely source of the fuel oil portion of the spilled oil.
3. Suspected source sample 96-096-5 is not derived from a common source of the spilled oil. *Slot tail.*
4. Comparison of suspected source sample 96-097-1 is inconclusive because they do not contain a sufficient quantity of petroleum oil for comparison purposes.

*Mantel as Hendrick*

SUPERVISOR OF ANALYSIS M. S. HENDRICK, Ph.D. DATE: 20DEC95  
Chemist

U. S. COAST GUARD  
MARINE SAFETY LABORATORIES

MSL CASE #: 96-097      REQUESTOR MSO PUGET SOUND      UNIT CASE MC95015622  
 METHOD OF DELIVERY: CERTIFIED MAIL      TRACKING #: P 902 422 199      FPN: 13-6001  
 DATE MAILED: 07-Dec-95      DATE RECEIVED: 14-Dec-95      SAMPLES TAMPERED WITH? No  
 SAMPLES BROKEN? No      SAMPLES LEAKING? No      NETS? No      CRIMINAL? No

MSL #	DESCRIPTION	DATE/TIME TAKEN	SPILL/SOURCE
96-097-1	1 WELL ON RIGHT SIDE OF ROAD NEAR FENCE LINE MOBIL WELL	06 DEC 95 1200	SOURCE
96-097-2	2 BACK NE WELL INSIDE CONTAINMENT AREA OF AMERICAN DISTRIBUTING	06 DEC 95 1225	SOURCE
96-097-3	3 FROM WATER OUTLET AT DUNLAP TOWING	06 DEC 95 1340	SPILL
96-097-4	4 SAMPLE OF OUTFALL AT DUNLAP TOWING	06 DEC 95 1345	SPILL
96-097-5	5 NO 3 TANK SCOTT PAPER IN CONTAINMENT YARD #6 FUEL	06 DEC 95 1315	SOURCE

REMARKS: COMPARE TO CASE 96-013

Samples checked in by: James P. Grigg      Date: 15 DEC 95  
 Sample Custodian: [Signature]      Date: 15 DEC 95  
 Supervisor of analysis: Manthos Hendrick      Date: 18 Dec 95

12-7-95  
Date

From: Commanding Officer, MARINE SAFETY OFFICE PUGET SOUND  
To: Commanding Officer, Marine Safety Laboratories

Subj: REQUEST FOR OIL SAMPLE ANALYSIS

1. Request analysis of the 5 samples listed on attached Chain of Custody Record to assist in our investigation of spill case  
FPS 13-6001 MC95015622  
(Federal Project Number and Marine Casualty "MC" number)

2. Questions concerning this case should be directed to  
BMT2 CHRIS P. SCARBORRY COMMERCIAL# 206-217-6232.

3. The spill samples were collected from SEWER OUTFALL, MOBILE  
WELL, AMERICAN DISTRIBUTING WELL, FUEL TANK  
(river, outfall, shore, etc)

4. Estimated number of gallons spilled 50; Estimated cost of cleanup 35,000.

5. Wind conditions: \_\_\_ mild breeze; \_\_\_ Very Windy; X Calm.

6. Air Temperature: \_\_\_ below 32F; X 32 to 60F; \_\_\_ 60 to 85F  
\_\_\_ 85 to 95F; \_\_\_ over 95F.

7. Sky conditions: X Overcast; \_\_\_ Bright Sun; \_\_\_ Rain;  
Other (specify) \_\_\_\_\_.

8. Spill involves seepage of oil through the soil: X Yes \_\_\_ No.  
If Yes, estimated distance to the nearest possible suspected source:

300 YARDS

9. List any possible non-petroleum contamination sources in the area NONE

10. Are all samples involved in this case being sent to the laboratory? YES If not, explain \_\_\_\_\_.

11. Have all possible suspect sources been sampled, YES If NO, include a detailed explanation of possible sources not sampled. Provide any additional information about the samples or overall situation which may be helpful to lab personnel: \_\_\_\_\_.

PLEASE SAMPLE SEPARATE THEN COMPARE TO CASE  
96-013

12. Specify prosecution type: X Class 1; \_\_\_ Class 2; \_\_\_ DOJ.

(SIGNATURE)  
MST3 Don LaSore, Don LAISORE

**UNITED STATES COAST GUARD  
CHAIN OF CUSTODY RECORD**

(UNIT AND ADDRESS)	COMMANDING OFFICER U.S. COAST GUARD MARINE SAFETY OFFICE PUGET SOUND 1519 ALASKAN WAY SOUTH SEATTLE, WA. 98134-1192
--------------------	--

SPILL	SOURCE	SAMPLE NO.	DESCRIPTION OF SAMPLES FOR CASE# <u>MC95015622</u>
	XXV	1	WELL ON RIGHT SIDE OF ROAD NEAR FENCE LINE mobile well
	XXX	2	BACK WE WELL INSIDE CONTAINMENT AREA OF AMERICAN DISTRIBUTING
XXX		3	FROM WATER OUTLET AT DUNLAP TOWING
XXX		4	FROM WATER OUTLET AT DUNLAP TOWING
	XXX	5	FROM CONTAINER YARD AT SCOTT PAPER #3 TANK CONTAINING #6 FUEL OIL

PERSON ASSUMING RESPONSIBILITY FOR SAMPLES					TIME/DATE
SAMPLE NUMBER	RELINQUISHED BY:	DATE/TIME	RECEIVED BY:	DATE/TIME	REASON FOR CHANGE OF CUSTODY
1-5	<i>Chris P. Seabury</i> B/M2 C.P. SEABURY	12-6-95 1654	<i>Don Laisure</i> DON LAISURE, USCG	12-6-95 1654	STORAGE
SAMPLE NUMBER	RELINQUISHED BY:	DATE/TIME	RECEIVED BY:	DATE/TIME	REASON FOR CHANGE OF CUSTODY
1-5	<i>Don Laisure</i> DON LAISURE, USCG	12-7-95 0700	CHRIS, P. SEABURY B/M2 Chris P. Seabury	12-7-95 0700	SHIP TO COIL
SAMPLE NUMBER	RELINQUISHED BY:	DATE/TIME	RECEIVED BY:	DATE/TIME	REASON FOR CHANGE OF CUSTODY
1-5	<i>Chris P. Seabury</i> B/M2 CHRIS P. SEABURY	12-7-95 0704	<i>David Paperrier</i>	14 DEC 95 0930	
SAMPLE NUMBER	RELINQUISHED BY:	DATE/TIME	RECEIVED BY:	DATE/TIME	REASON FOR CHANGE OF CUSTODY



**SAMPLE PREPARATION SHEET**

COIL CASE NUMBER: 96-097

DATE PREPARED: 15 DEC 95

Oil samples were obtained using preparation techniques listed below. The samples were then placed into a vial and identified with the COIL case number and sample number along with the corresponding preparation code(s)

Oil samples eliminated by IR screening method: \_\_\_\_\_

The Quality Control sample is a duplicate of sample: 96-097-2

SAMPLE NUMBERS (sequential portion only)	PREPARATION CODE	RATIO
1, 3, 4	5, 7	
2, QC	2	
5	3, 7	

**PREPARATION CODES**

1. Portion of neat sample taken from sample jar (clean fuel oils).
2. Portion of sample taken from sample jar, anhydrous MgSO<sub>4</sub> added, then centrifuged.
3. Portion of sample taken from sample jar, diluted with cyclohexane, anhydrous MgSO<sub>4</sub> added, then centrifuged.
4. Entire sample extracted with cyclohexane, anhydrous MgSO<sub>4</sub> added, then centrifuged.
5. Entire sample extracted with two separate 10 ml portions of cyclohexane, anhydrous MgSO<sub>4</sub> added to the combined cyclohexane solution, then centrifuged.
6. Cyclohexane Solution: ratio of oil to cyclohexane is known and shown in "ratio" column.
7. Cyclohexane Solution of unknown concentration.
8. Solvent evaporated with heat and a stream of N<sub>2</sub>. Sample of unknown concentration.
9. Others: \_\_\_\_\_

Preparer's Signature: James P. Griffin

Date: 15 DEC 95

QUALITY CONTROL SHEET

COIL CASE NUMBER: 96-097

DATE PREPARED: 15 DEC 95

1. A Quality Control (QC) sample was analyzed along with the other samples in this case.

The Quality Control (QC) is a duplicate of sample 96-097-2  
 Due to limited sample quantity in all samples involved in the case, reference oil \_\_\_\_\_ from the COIL Library was used for the Quality Control (QC) and its duplicate sample.  
 Infrared Spectroscopy used for screening samples before final sample preparation. No QC sample available during IR screening

2. ANALYTICAL METHODS.

INFRARED SPECTROSCOPY

GAS CHROMATOGRAPHY

FLUORESCENCE SPECTROSCOPY

GAS CHROMATOGRAPHY/MASS SPECTROMETRY

SAT	N/A
	X
X	
	X
X	

3. The data and conclusions for the QC and its duplicate were identical:

Yes X No \_\_\_\_\_

COMMENTS:

SUPERVISOR OF ANALYSIS:

Martha Hendrick

DATE: 20 Dec 95

UNITED STATES COAST GUARD  
MARINE SAFETY LABORATORY

OIL SPILL IDENTIFICATION ANALYSES  
COST RECOVERY DOCUMENTATION

LABORATORY CASE NUMBER: 96-097

REQUESTOR: MARINE SAFETY OFFICE PUGET SOUND

UNIT CASE NUMBER: MC95015622

NUMBER OF SAMPLES: 05

COST PER SAMPLE PREPARED: \$20.00

TOTAL COSTS OF SAMPLE PREPARATION: \$100.00

NUMBER OF ANALYSES: 15

COST PER ANALYSIS: \$85.98

TOTAL COSTS FOR ANALYSIS: \$1289.70

TOTAL COSTS: \$1389.70

This documentation is provided for purposes of Phase IV -  
Documentation and Cost Recovery under the National Oil and  
Hazardous Substances Pollution Contingency Plan(40 CFR Part 300).

*Martha S. Hendrick*

MARTHA S. HENDRICK DATE: 20DEC95  
Chemist

## OIL SPILL IDENTIFICATION SYSTEM (OIS)

RELEVANCE TO SPILL SOURCE DETERMINATION

Petroleum is a complex mixture of thousands of different organic compounds formed from a variety of organic materials that are chemically converted under differing geological conditions over long periods of time. The infinitely variable nature of these factors results in distinct chemical differences between oils formed under dissimilar conditions and/or environments. While oil from one crude oil field is readily distinguishable from another, differences in the makeup of oils from the same crude oil field can sometimes be observed as well. Refined oils are fractions usually derived by distillation of crude oil. Two refined oils of the same type differ because of dissimilarities in the characteristics of their crude oil feed stocks as well as variations in refinery processes and any subsequent contact with other oils mixed in during transfer operation from residues in tanks, ships, pipes, hoses etc... Thus, all petroleum oils, to some extent have chemical compositions that differ from each other.

The characteristic properties of an oil can be explored by a variety of analytical methods. The results of analysis by any of these methods can be presented in graph form. In general, when the graphical data for two oils produced by a particular method are compared, the differences between the graphs reflect differences between the oils.

The OIS System, developed during the mid-1970s at the Coast Guard Research and Development Center, is based on a multi-method approach to "fingerprinting" oils. In 1978, the Central Oil Identification Laboratory (COIL) was established as the operating facility to implement the OIS. In 1988, COIL was renamed the Marine Safety Laboratories (MSL), though the acronym COIL is still widely used. OIS is designed to determine the unique, intrinsic chemical properties of oils via analytical techniques and establish whether or not a common source relationship exists between samples of spilled oil and samples of oil from a suspected source. Since 1978, MSL/COIL has analyzed over 39,000 samples, involving more than 5,700 spill cases, in support of oil pollution investigations.

DATA PRODUCTION AND INTERPRETATION

Oil sample preparation, testing and storage are conducted in accordance with American Society for Testing and Materials (ASTM) consensus standards. MSL/COIL currently utilizes three primary analytical techniques: Gas Chromatography (GC) (ASTM D-3328), Fluorescence Spectroscopy (FL) (ASTM D 3650), Infrared Spectroscopy (IR) (ASTM D-3414), and Gas Chromatography-Mass Spectrometry (GC-MS) (ASTM D-5739) that is used as a complementary analytical method. A rigorous laboratory quality assurance program monitors both instrument performance and sample preparation to ensure that data are accurate and reproducible.

All samples in a given case are initially analyzed by one method to determine the class of petroleum product. Samples can be excluded from further analysis based on results from the initial analysis. Further analyses are performed on samples which are potential matches to the source of the oil.

The Supervisor of Analysis interprets the data from all test methods performed and draws conclusions concerning whether or not certain spilled oil and suspected source samples were derived from the same chemical source. Data interpretation in oil spill source identification is non-trivial and fundamentally different from typical chemical analyses because the chemical properties of spilled oil are altered when oil is introduced into the environment. From the moment oil enters the environment, evaporation, dissolution, photochemical oxidation, biodegradation and other forces begin to alter the oil's characteristics or "fingerprint". These combined processes are termed weathering and can significantly complicate data interpretation. Contamination of the spilled oil with other oils or substances is another complicating factor. The experienced oil spill analyst is familiar with the complexities of the weathering processes and is able to distinguish real differences between two oils from those apparent differences resulting from weathering alterations. Interferences from contaminants can usually be recognized as such and discounted when weighing the test results. However, at times, severe weathering and/or contamination can mask many of the inherent differences between oils of a similar type.

#### REPORTING

The typical MSL/COIL OIS Report consists of four parts: case identifying information, a listing of analysis techniques performed, the results section and the conclusions section. The results section describes the types of petroleum observed in the samples provided, and comments on chemical similarities or dissimilarities between spill samples and/or between spill and suspected source samples. In all cases the Supervisor of Analysis bases the written results on interpretations from the aggregate of all data generated.

The conclusions section establishes whether or not a common source relationship exists between samples of spilled oil and samples of oil from a suspected source. There are two outcomes most frequently found in the conclusions section of the typical MSL/COIL OIS Report: "derived from a common source" and "not derived from a common source". However, to maintain the high degree of reliability for both "common source" and "not a common source" determinations, it is necessary to exclude some comparisons from these categories. Oil spill cases vary widely in possible explanations for why a determination could not be made. Instead of using only a statement of "inconclusive", the comments will concisely explain the reason for the outcome for each individual case. For example, some sources are highly inhomogeneous, and a sample of such a spill may not reflect the composition of the product remaining in such a source. The spill may contain very little oil, or it may be excessively weathered or contaminated. Of important note, MSL/COIL conclusions address chemical comparisons and not physical aspects of evidence. Additionally, chemical evidence provided in a MSL/COIL conclusion that is other than "common source" might still be used by the investigating officer, when combined with physical evidence to establish a preponderance of the evidence argument against an alleged responsible party.

MSL/COIL OIS Reports are submitted to Marine Safety Offices (MSO's) for inclusion, as chemical evidence, in Marine Violation/Casualty Reports. The outcomes in the conclusions section of the OIS Report define the nature of the chemical evidence provided. MSO personnel are advised to combine the chemical evidence provided in the MSL/COIL OIS Reports with physical and circumstantial evidence developed during the investigation when writing Marine Violation Reports. Inquiries challenging the technical content of MSL/COIL OIS Reports by representatives of the alleged responsible party should be handled at the Hearing Officer level. Explicit guidance describing the communications process between the Hearing Officer and the MSL/COIL Supervisor of Analysis on technical issues involving chemical evidence is given in Commandant (G-LMI) memorandum 16460 dated 26 January 1981.

#### PERSONNEL QUALIFICATIONS

MSL/COIL laboratory technicians performing sample preparation and testing are graduates of the Coast Guard Marine Science Technician School. Each MSL/COIL technician has successfully completed a comprehensive training program at the MSL/COIL facility. Additionally, many have received supplemental training at leading civilian institutions in their specialty area.

The Supervisor of Analysis monitors all aspects of the analysis, certifies and interprets the test results, and prepares the final MSL/COIL report. This individual is a professionally trained chemist experienced in oil spill source identification. Individuals currently qualified to perform this function are:

Lieutenant Commander Kristy L. Plourde, U.S. Coast Guard  
Commanding Officer  
B.S. Physical Sciences, 1983, US Coast Guard Academy  
M.S. Chemistry, 1989, University of Connecticut

Dr. Martha Hendrick  
Chemist  
B.A. Chemistry, 1969, Rhodes College  
M.A. Education, 1974, Stanford University  
Ph.D. Analytical Chemistry, 1985, University of Connecticut  
Chair, ASTM Subcommittee D19.31, Waterborne Oils

#### REFERENCES

A more technical description of the OIS is contained in Report CG-D-52-77 "Oil Spill Identification System", Final Report, June 1977, USCG R&D Center. This document is available through the National Technical Information Service, Springfield, VA 22161.

For information concerning the ASTM standards used in Oil Spill Identification, consult "Oil in the Environment", Martha S. Hendrick, Ph.D., ASTM Standardization News, April 1991.

For additional information regarding the applicability of the Coast Guard's OIS, see "Chemical Identification of Oil Spill Sources", Allen P. Bentz, Ph.D., The Forum, Volume XIII, Number 2, Winter 1978. Dr. Bentz is a research scientist at the Coast Guard Research and Development Center and a recognized expert in the field of oil spill source identification. He has been closely involved with most of the development work leading to the present state-of-the-art.

OIL SAMPLE ANALYSIS REPORT  
MARINE SAFETY OFFICE PUGET SOUND  
CASE NUMBER MC95015622

MARINE SAFETY LABORATORY  
CASE NUMBER 96-117

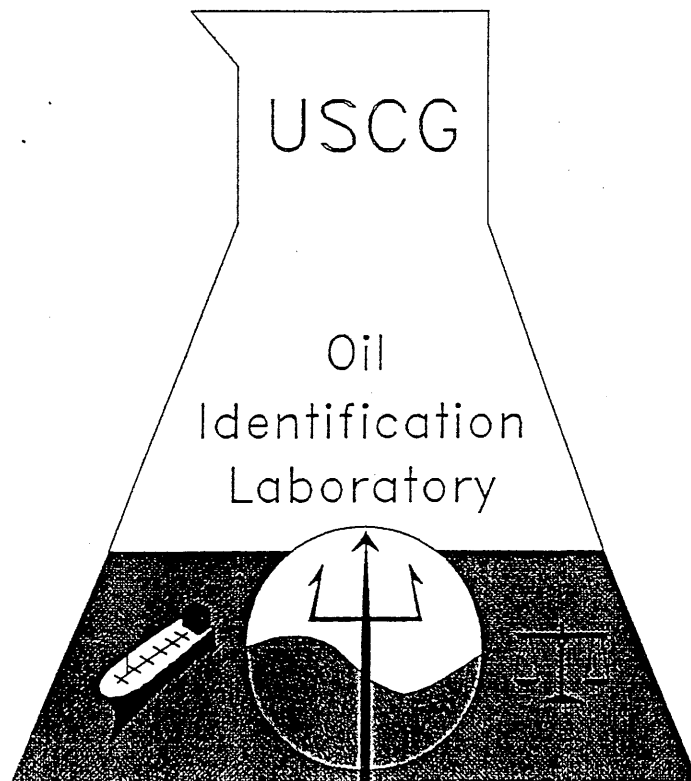

U.S. Department  
of Transportation

United States  
Coast Guard



Commanding Officer  
U. S. Coast Guard  
Marine Safety  
Laboratories

1082 Shennecossett Road  
Groton, CT 06340-6094  
Phone: (860) 441-2645  
Fax: (860) 441-2641

16400

JAN 16 1996

From: Commanding Officer, Marine Safety Laboratories  
To: Commanding Officer, Marine Safety Office Puget Sound

Subj: OIL SAMPLE ANALYSIS REPORT, MSO PUGET SOUND CASE# MC95015622  
MSL CASE #96-117

1. The laboratory analysis of this case has been completed and our report is forwarded. The technical data supporting the report (spectrograms and chromatograms) have been archived at our facility and are available upon request. We will maintain the oil samples in refrigerated storage pending final case disposition.

2. Questions concerning this report or the analytical methods used should be directed to the Supervisor of Analysis, LCDR Plourde.

  
K. L. PLOURDE

Encl: (1) MSL Report 96-117  
(2) OIS Addendum



UNITED STATES COAST GUARD MARINE SAFETY LABORATORIES  
OIL IDENTIFICATION LABORATORY

OIL SPILL IDENTIFICATION REPORT

LABORATORY CASE NUMBER: 96-117

REQUESTOR: MARINE SAFETY OFFICE PUGET SOUND

UNIT CASE NUMBER: MC95015622

RECEIVED: 12JAN96 VIA: CERTIFIED MAIL (# P 902 422 187)

NUMBER OF SAMPLES: FIVE (05)

LAB NO. OF SPILLS: 96-117-1

LAB NO. OF SUSPECTS: 96-117-3, 4 AND 5

LAB NO. OF CLEAN WATER: 96-117-2

ANALYSIS METHODS:

GAS CHROMATOGRAPHY (GC)

RESULTS:

1. Sample 1 was specified to have been representative of spilled oil. Analysis indicates that it contains a slightly weathered and severely biodegraded petroleum oil.
2. Suspected source samples 3, 4, and 5 are observed to contain heavy fuel oils with characteristics different than those observed for the spilled oil sample.
3. Sample 2 was designated as a clean water sample. No petroleum oil was detectable by Gas Chromatography.

CONCLUSIONS:

1. Because of the severely biodegraded condition of spill sample 1, comparison with suspected source samples 3, 4 and 5 is inconclusive. Suspected source samples 3, 4, and 5 do not appear to be the source of spill sample 1. The slightly weathered and severely biodegraded condition of sample 1 is characteristic of an oil that has been retained in a contaminated environment, such as soil, for an extended period of time.
2. Sample 2 represents essentially oil-free water.

  
SUPERVISOR OF ANALYSIS K. L. FLOURDE, LCDR, USCG DATE: 16JAN96  
Commanding Officer/Chemist

11/89

UNITED STATES COAST GUARD  
OIL IDENTIFICATION LABORATORY

SAMPLE CHECK-IN LOG, COIL CASE NUMBER: 96-117

REQUESTOR: MSO PUGET SOUND

UNIT CASE#: MC95015622

METHOD OF DELIVERY			DATE RECEIVED
XXXXXXXXXX/CERTIFIED MAIL NUMBER	DATE MAILED O/A	MESSENGER	OTHER
P 902 422 187	09 JAN 96		12 JAN 96

Samples were observed to be: broken NO, tampered with NO, leaking YES, or subject to contamination NO. For these and other unusual conditions, place an asterisk (\*) next to the sample(s) in question and describe condition of sample(s) in remarks below.

LAB NO.	SAMPLE DESCRIPTION	SPILL	SUSPECT
96-117-1	[1] OIL RECOVERED IN THE WATER 08 JAN 96 1503	XXXXX	
96-117-2	[2] FRESH WATER SAMPLE 08 JAN 96 1529	XXXXX	
96-117-3	[3] PIPE OUTSIDE PUMP STATION 08 JAN 96 1400		XXXXX
** 96-117-4	[4] SOUTH WALL FUEL YARD MIDDLE 08 JAN 96 1410		XXXXX
96-117-5	[5] MIDDLE SOUTH WALL STAND PIPE 08 JAN 96 1415		XXXXX

REMARKS:  
\*\* SAMPLE 96-117-4 WAS RECEIVED LEAKING

Samples checked-in by: [Signature] Date: 12 JAN 96  
 Sample Custodian: [Signature] Date: 12 JAN 96  
 Supervisor of Analysis: KE Plomdo Date: 16 JAN 96

From: Commanding Officer, MARINE SAFETY OFFICE Puget Sound  
To: Commanding Officer, Marine Safety Laboratories

Subj: REQUEST FOR OIL SAMPLE ANALYSIS

1. Request analysis of the 5 samples listed on attached Chain of Custody Record to assist in our investigation of spill case  
13-6001 MC95015622  
(Federal Project Number and Marine Casualty "MC" number)

2. Questions concerning this case should be directed to  
Bm2 CHRIS P. SCARBERRY COMMERCIAL# 206 219-6232

3. The spill samples were collected from OUTFALL, BAY, SAWHOLE PIPE SHORE  
(river, outfall, shore, etc)

4. Estimated number of gallons spilled 200; Estimated cost of cleanup 10,000.

5. Wind conditions:      mild breeze;      Very Windy; X Calm.

6. Air Temperature:      below 32F; X 32 to 60F;      60 to 85F  
     85 to 95F;      over 95F.

7. Sky conditions: X Overcast;      Bright Sun;      Rain;  
Other (specify) BUT PARTLY SUNNY

8. Spill involves seepage of oil through the soil: X Yes      No.  
If Yes, estimated distance to the nearest possible suspected source:  
200 YARDS

9. List any possible non-petroleum contamination sources in the area NONE

10. Are all samples involved in this case being sent to the laboratory? YES If not, explain     

11. Have all possible suspect sources been sampled, YES If NO, include a detailed explanation of possible sources not sampled. Provide any additional information about the samples or overall situation which may be helpful to lab personnel:  
NEED MOST ALKYLATIC TEST DONE. NEED GAS  
CHROMATOGRAPHY SENT TO UNIT FOR ECOLOGY STUDY

12. Specify prosecution type: X Class 1;      Class 2;      DOJ.

(SIGNATURE)  
MST3

UNITED STATES COAST GUARD  
 CHAIN OF CUSTODY REPORT  
 U.S. COAST GUARD

(UNIT AND ADDRESS)

MARINE SAFETY OFFICE  
 PUGET SOUND  
 1515 ALASKAN WAY SOUTH  
 SEATTLE, WA. 98134-1192

SPILL SOURCE SAMPLE NO. DESCRIPTION OF SAMPLES FOR CASE# MC95015622

XXY		1	OIL RECOVERED FROM WATER
XXY		2	FRESH WATER SAMPLE 100 YARDS FROM SPILL
	XXY	3	PIPE OUTSIDE PUMP STATION
	XXY	4	SOUTH WALL FUEL YARD MIDDLE
	XXX	5	SOUTH WALL FUEL YARD STAND PIPE

PERSON ASSUMING RESPONSIBILITY FOR SAMPLES

TIME/DATE

SAMPLE NUMBER	RELINQUISHED BY:	DATE/TIME	RECEIVED BY:	DATE/TIME	REASON FOR CHANGE OF CUSTODY
1-5	<i>[Signature]</i> BM2 G.P. Seaberg	9 JAN 96 1800	MST3 <i>[Signature]</i>		STORAGE
1-5	MST3 <i>[Signature]</i>		<i>[Signature]</i> BM2 Seaberg	69 JAN 96 6700	SHIP TO COIL
1-5	<i>[Signature]</i> BM2 Chi P. Seaberg	9 JAN 96 0800	<del>_____</del> TROY FREIHANMER N773 AT 1132	12 JAN 96 0915	
SAMPLE NUMBER	RELINQUISHED BY:	DATE/TIME	RECEIVED BY:	DATE/TIME	REASON FOR CHANGE OF CUSTODY

Bill No.  Returned CODs  Registered  Return Rcpt. for Merchandise  Insured  Certified  Int'l. Recorded Delivery Svc. Mail for **Coast Guard**

No. of Article	* Code	Office of Origin Use ONLY for International	No. of Article	* Code	Office of Origin Use ONLY for International
1		Seattle WA	11		A.S. Russell
2			12		
3			13		
4			14		
5			15		
6			16		
7			17		
8			18		
9			19		
10			20		

\*CODE: R = Return Receipt Requested. OS = Officially Sealed. RE = Re-enveloped. SD = Special Delivery.  
RW = Returned to Writer. DC = Received in Damaged Condition.

Date of Delivery: **1-12-96**  
 Delivered by (Clerk or Carrier): **Jm**  
 Received the: **1**  
 Pieces Described Above:  
 Addressee: **Agent Helen R Nelson**

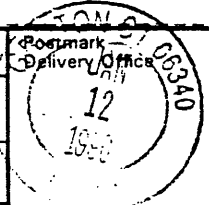

COIL CASE NUMBER: 96-117

DATE PREPARED: 12 JAN 96

Oil samples were obtained using preparation techniques listed below. T samples were then placed into a vial and identified with the COIL case number and sample number along with the corresponding preparation code(

Oil samples eliminated by IR screening method: \_\_\_\_\_

The Quality Control sample is a duplicate of sample: 96-117-3

SAMPLE NUMBERS (sequential portion only)	PREPARATION CODE	RATIO
1, 4, 5	3, 7	
2	4, 7	
3, QC	2	

PREPARATION CODES

1. Portion of neat sample taken from sample jar (clean fuel oils).
2. Portion of sample taken from sample jar, anhydrous MgSO<sub>4</sub> added, then centrifuged
3. Portion of sample taken from sample jar, diluted with cyclohexane, anhydrous MgSO<sub>4</sub> added, then centrifuged.
4. Entire sample extracted with cyclohexane, anhydrous MgSO<sub>4</sub> added, then centrifuge
5. Entire sample extracted with two separate 10 ml portions of cyclohexane, anhydro MgSO<sub>4</sub> added to the combined cyclohexane solution, then centrifuged.
6. Cyclohexane Solution: ratio of oil to cyclohexane is known and shown in "ratio" column.
7. Cyclohexane Solution of unknown concentration.
8. Solvent evaporated with heat and a stream of N<sub>2</sub>. Sample of unknown concentration
9. Others: \_\_\_\_\_

Preparer's Signature: [Signature] Date: 12 JAN 96

QUALITY CONTROL SHEET

COIL CASE NUMBER: 96-117

DATE PREPARED: 12 JAN 96

1. A Quality Control (QC) sample was analyzed along with the other samples in this case.

✓ The Quality Control (QC) is a duplicate of sample 96-117-3  
Due to limited sample quantity in all samples involved in the case, reference oil \_\_\_\_\_ from the COIL Library used for the Quality Control (QC) and it's duplicate sample.  
Infrared Spectroscopy used for screening samples before final sample preparation. No QC sample available during IR screening.

2. ANALYTICAL METHODS.

INFRARED SPECTROSCOPY

GAS CHROMATOGRAPHY

FLUORESCENCE SPECTROSCOPY

GAS CHROMATOGRAPHY/MASS SPECTROMETRY

SAT	N/A
	X
X	
	X
	X

3. The data and conclusions for the QC and it's duplicate were identical:

Yes X No \_\_\_\_\_

COMMENTS:

SUPERVISOR OF ANALYSIS: JC Plande

DATE: 16 JAN 96

**UNITED STATES COAST GUARD MARINE SAFETY LABORATORIES  
OIL IDENTIFICATION LABORATORY  
GAS CHROMATOGRAPHY (GC) WORKSHEET**

Case Number: 96-117 Instrument: ANA 2 Date of Analysis: 16 JAN 96

	Comparison Spills										cyclo- hexane soln. (unk. conc.)	
	1	2										
1	/	-										X
2	-	/										X
3	I	-										X
4	I	-										X
5	I	-										X

1. Method/Analytical Conditions: **ASTM D 3328**  
 HP program used:  
 OIL Method  
 GAS Method  
 OTHER: \_\_\_\_\_

SOP: **MSLINST 5200.8**  
 Column Used: FRONT / REAR  
 Column: DB-5, 30m x 0.32mm ID  
 Film Thickness: 0.1 micron  
 Column Number: 3768943

2. Sample Preparation: Solvent: Cyclohexane  
 Concentration:  3.0 µL oil / 1000.0 µL solvent     Other: \_\_\_\_\_

3. Comments: Do comparisons show all spill samples the same?     Yes     No     N/A

Analyst: [Signature]  
 Supervisor: [Signature]

Date: 16 JAN 96  
 Date: 16 JAN 96  
 Page 1 of 1



Data File: C:\INFORM\2\DATA\0112\96 11:00:54  
Injection Date: 1/12/96 9:59:13 PM Seq. Line: 8  
Acq. Method: OIL1.M Vial No.: 8  
Operator: *m.l.k.* *PEK* Inj. No.: 1  
Sample Name: <sup>11703m</sup> 96-081-BLANK Inj. Vol.: not available  
Comments:

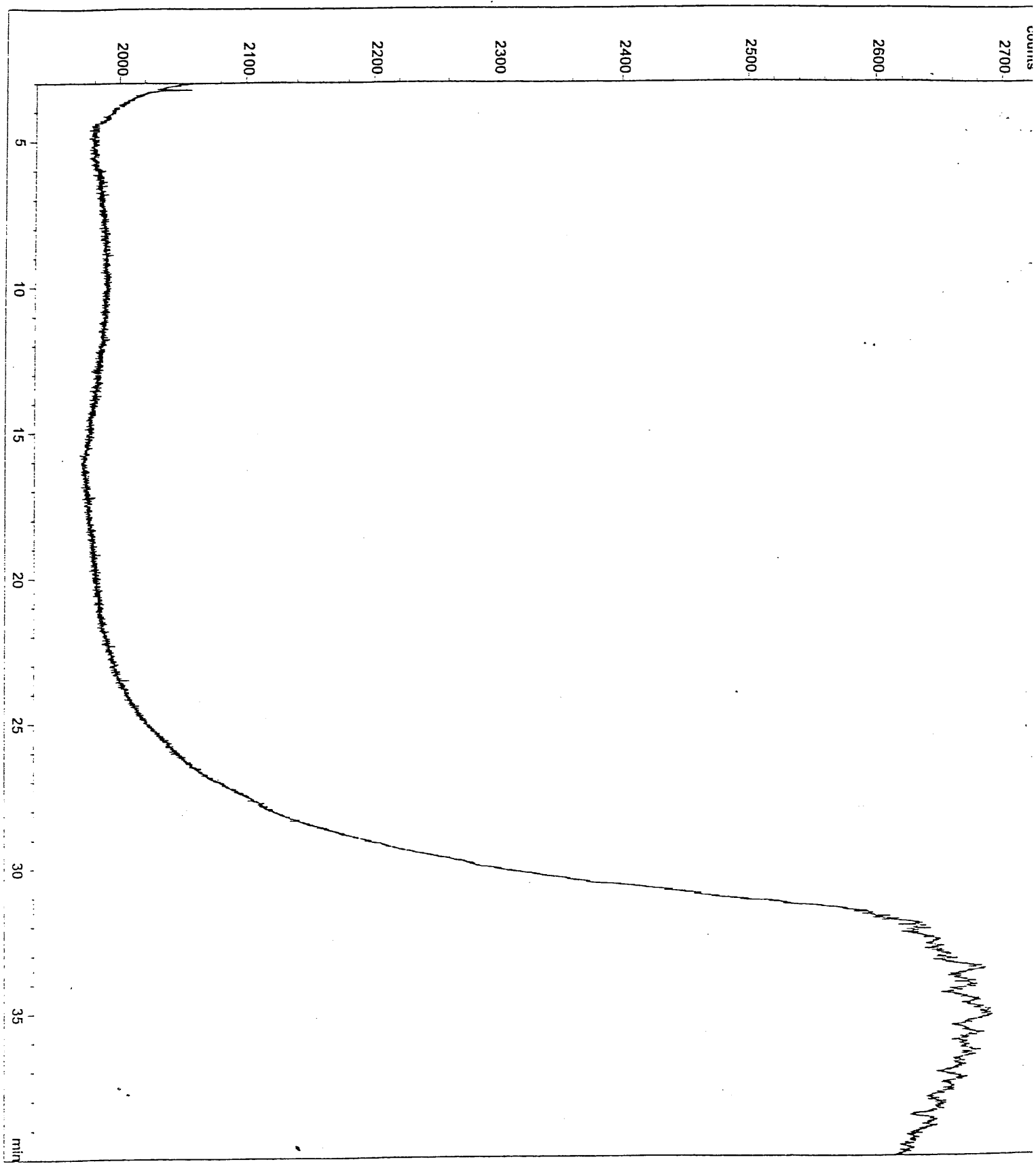

Injection Date: 1/12/96 8:52:03 PM  
Acq. Method: OIL1.M  
Operator: *[Signature]*  
Sample Name: 96-117-QC  
Comments:

Seq. Line: 7  
Vial No.: 7  
Inj. No.: 1  
Inj. Vol.: not available

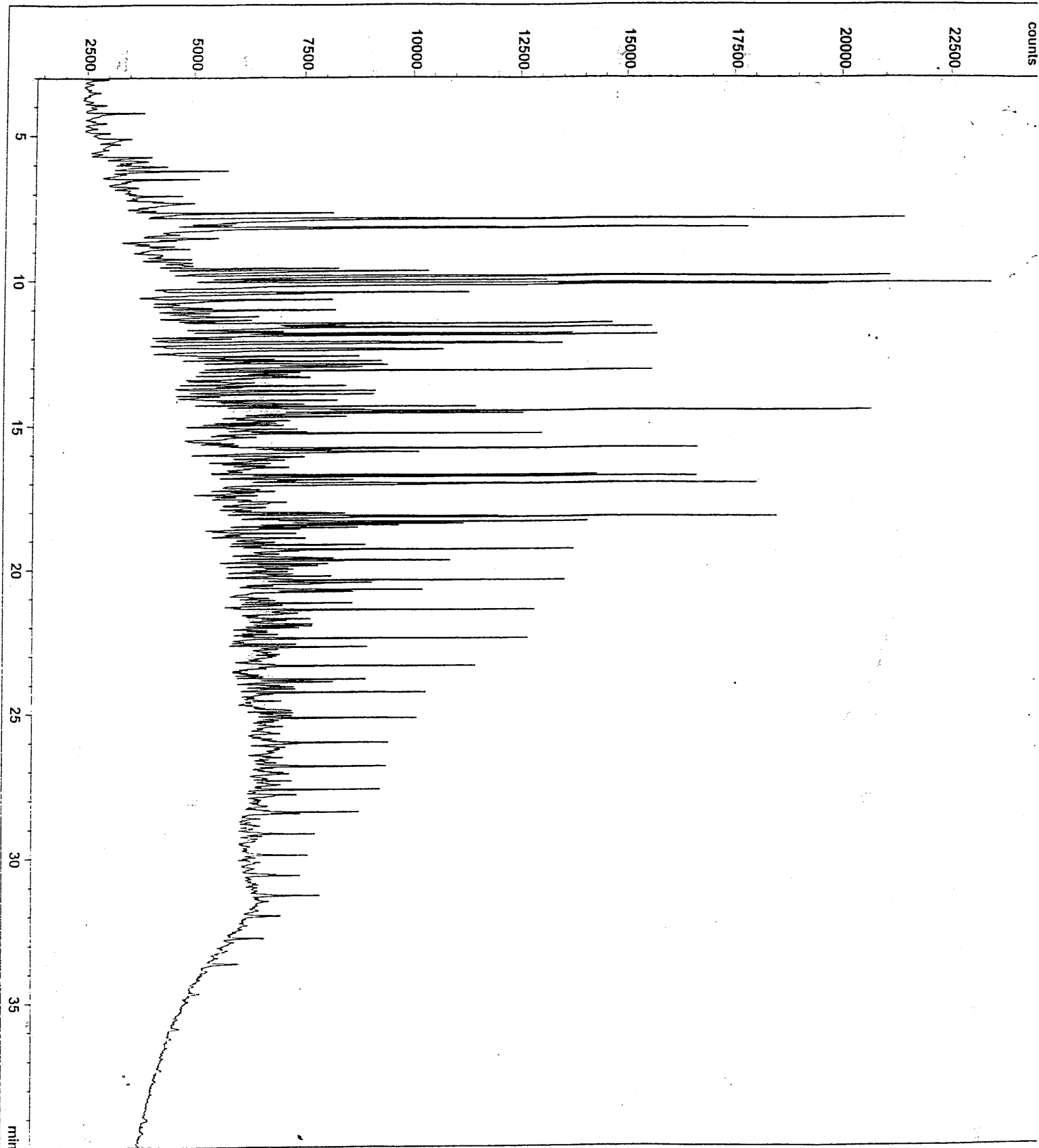

Data File: C:\MPCHEM\2\DATA\0112\96\117\021.D  
Injection Date: 1/12/96 3:16:33 PM Seq. Line: 2  
Acq. Method: OIL1.M Vial No.: 2  
Operator: *[Signature]* Inj. No.: 1  
Sample Name: 96-117-03, QCM Inj. Vol.: not available  
Comments:

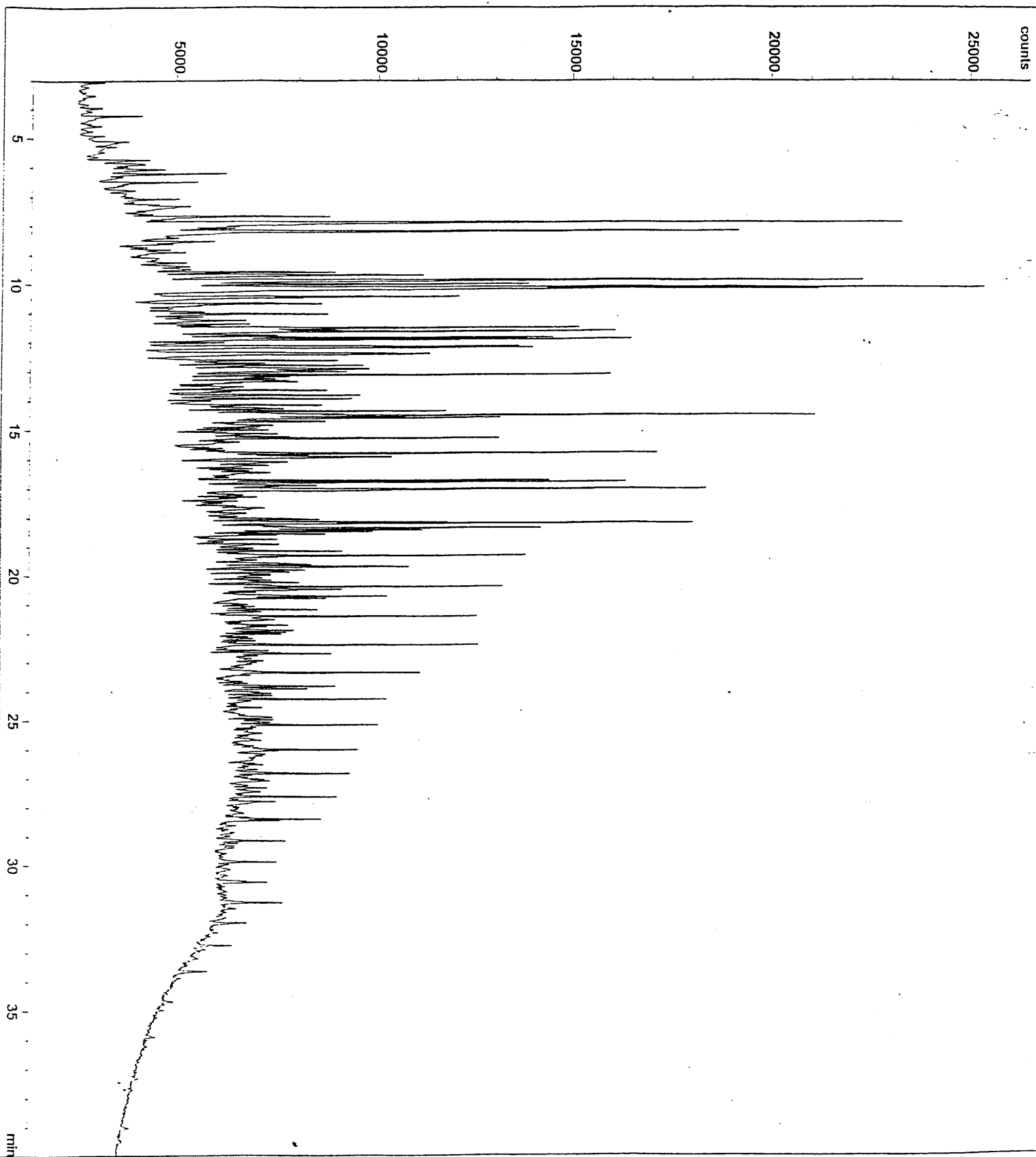

Data File:  
Injection Date: 1/12/96 4:23:38 PM  
Acq. Method: OIL1.M  
Operator: *[Signature]*  
Sample Name: 96-117-01, SPILL  
Comments:

Seq. Line: 3  
Vial No.: 3  
Inj. No.: 1  
Inj. Vol.: not available

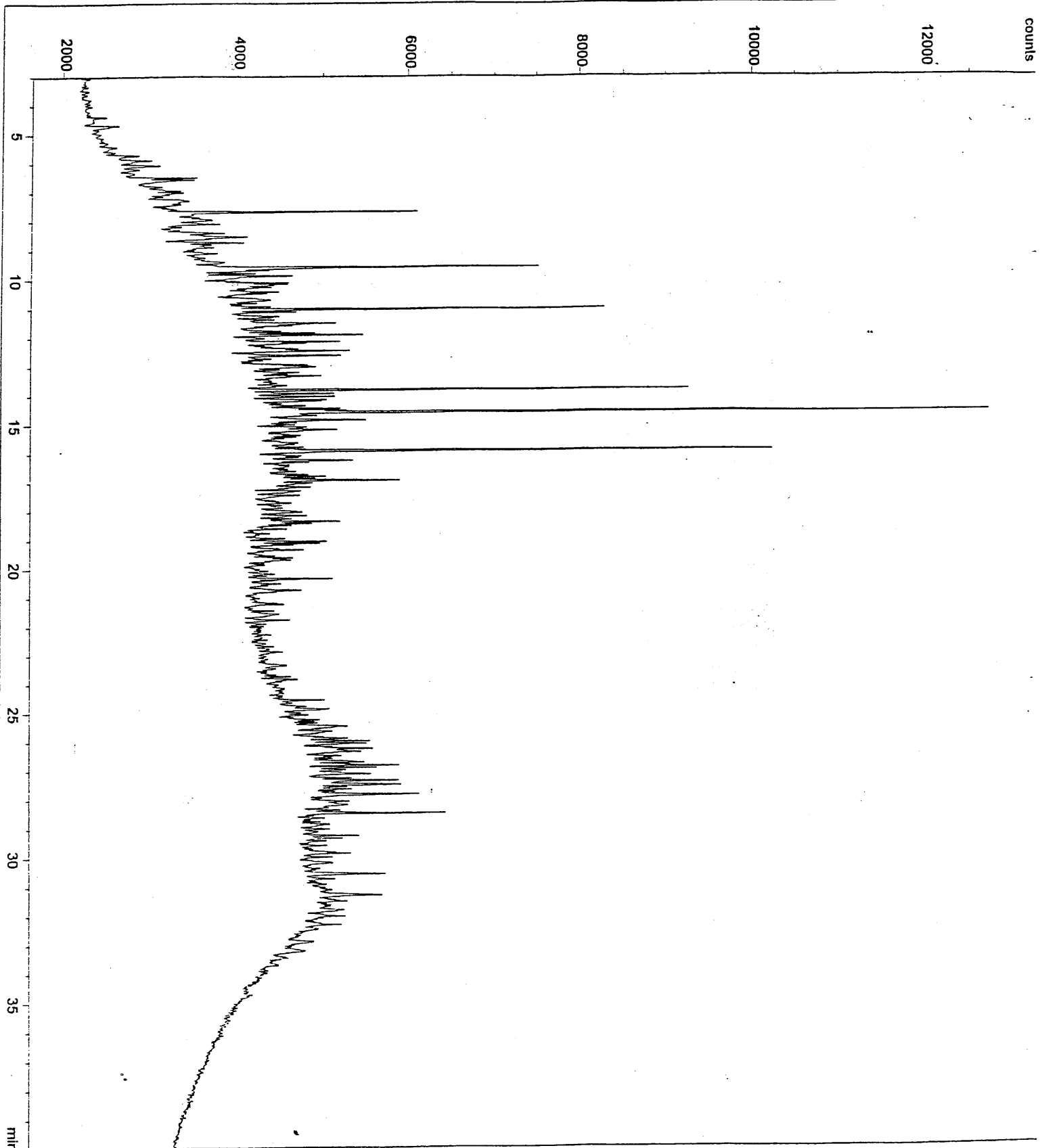

Data File: C:\INSTRUMENTS\DATA\OIL2\96-117-02  
Injection Date: 1/12/96 5:30:45 PM Seq. Line: 4  
Acq. Method: OIL1.M Vial No.: 4  
Operator: *[Signature]* Inj. No.: 1  
Sample Name: 96-117-02, SPILL Inj. Vol.: not available  
Comments:

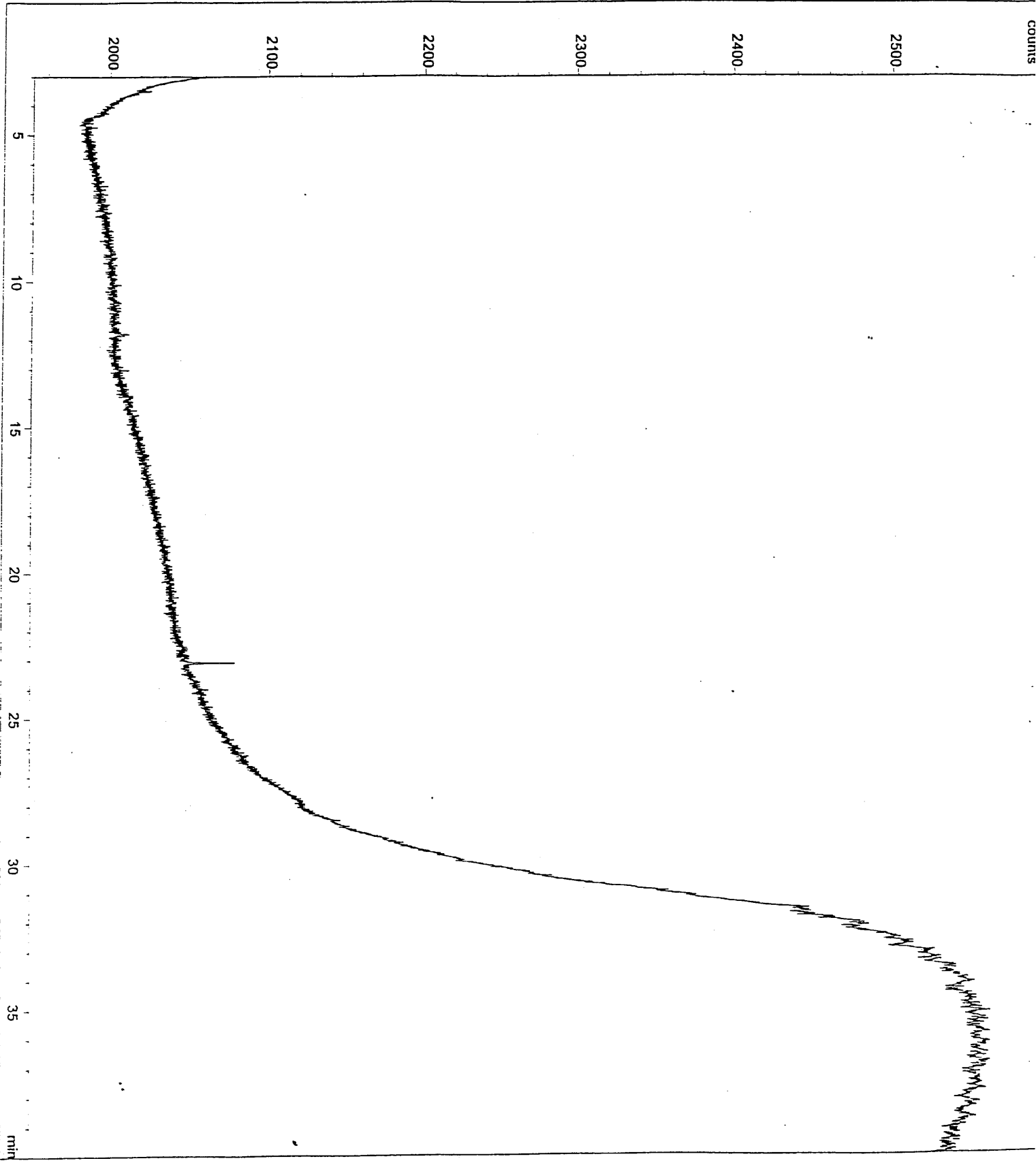

Data File: C:\MSDCHEM\2\DATA\961212\001.D  
Injection Date: 1/12/96 6:37:49 PM Seq. Line: 5  
Acq. Method: OIL1.M Vial No.: 5  
Operator: *[Signature]* Inj. No.: 1  
Sample Name: 96-117-04 Inj. Vol.: not available  
Comments:

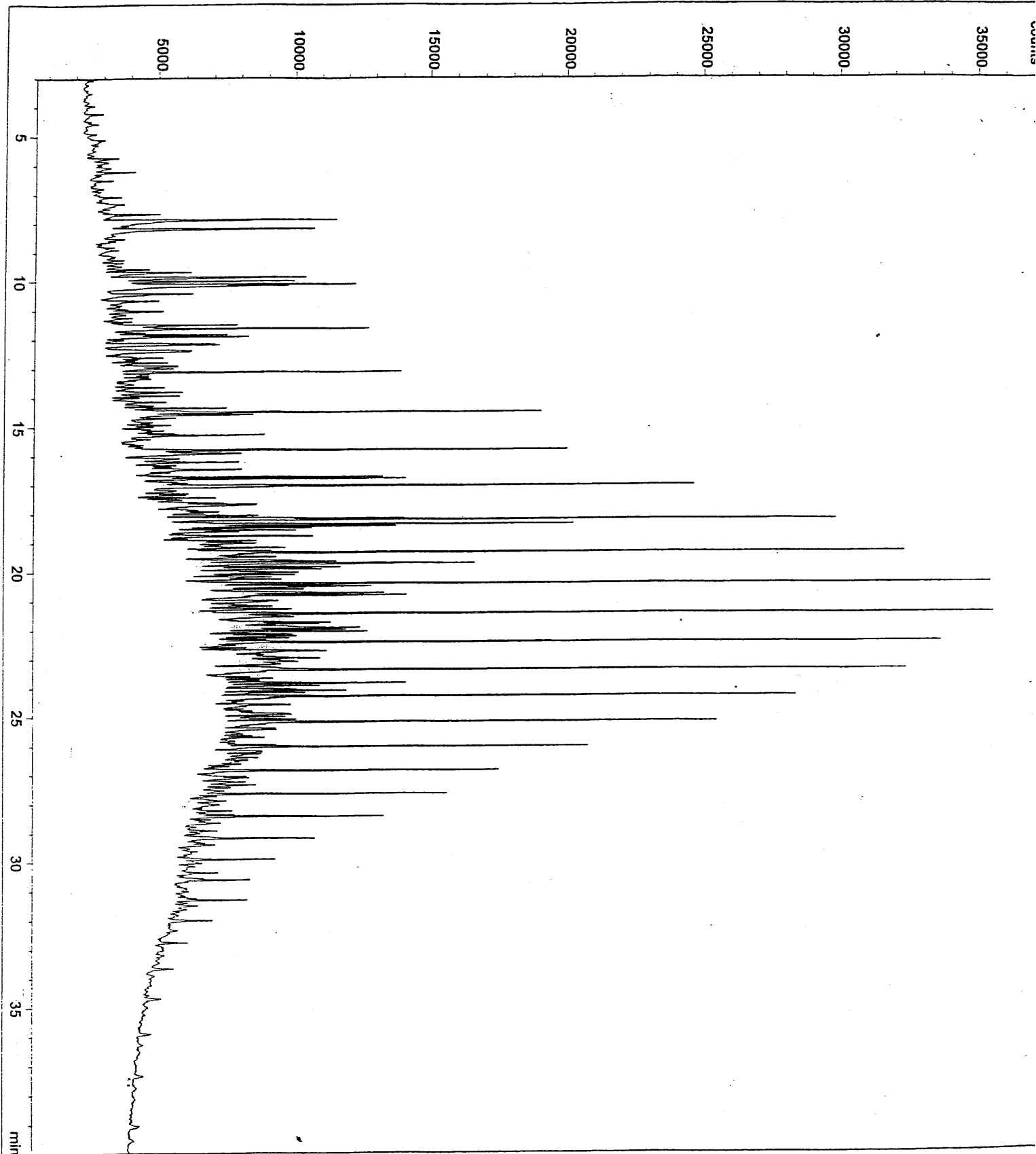

Data File: C:\HPCHEM1\2\DATA\0112\96-11706.D  
Injection Date: 1/12/96 7:44:55 PM Seq. Line: 6  
Acq. Method: OIL1.M Vial No.: 6  
Operator: *[Signature]* Inj. No.: 1  
Sample Name: 96-117-05 Inj. Vol.: not available  
Comments:

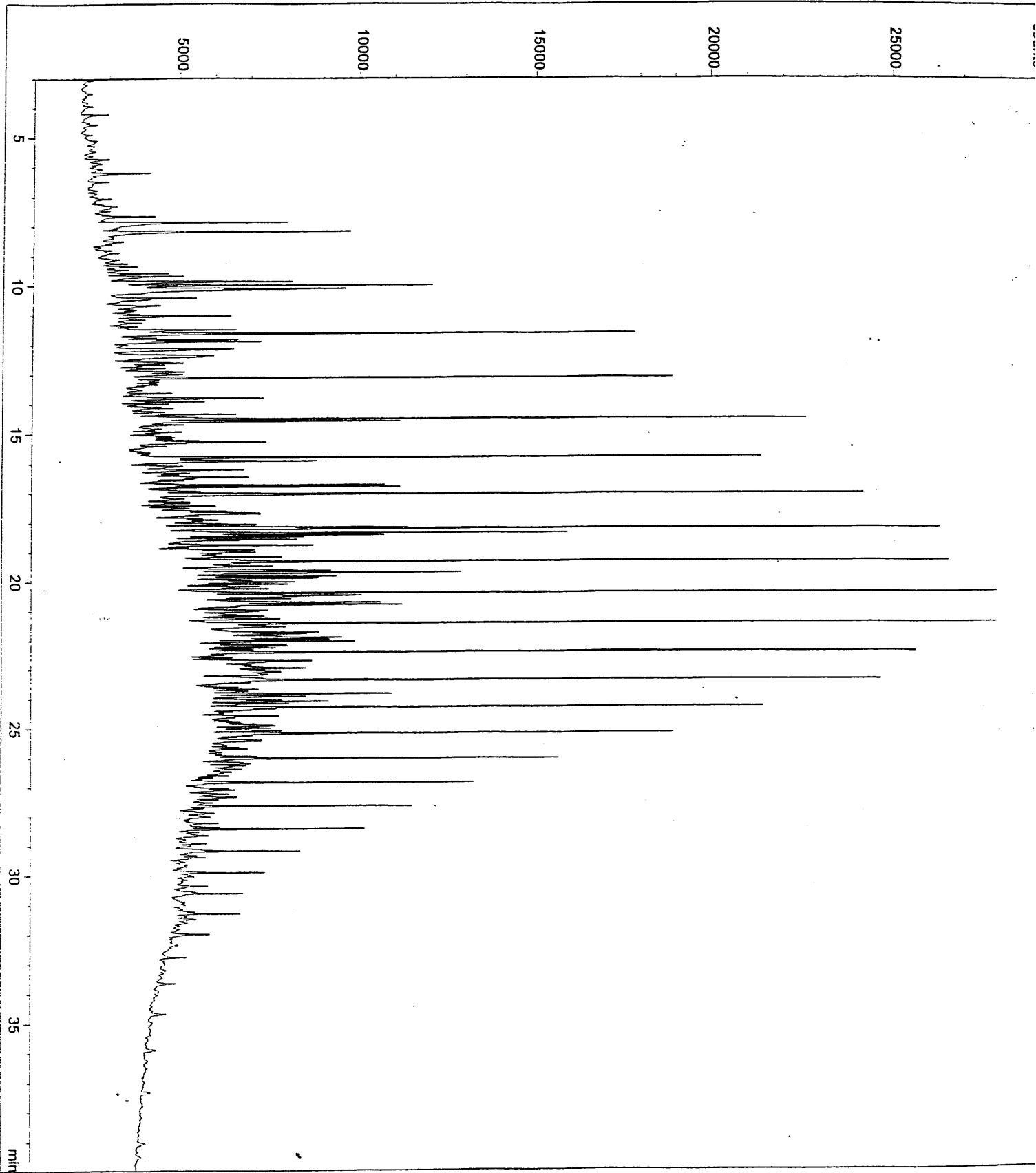

UNITED STATES COAST GUARD  
MARINE SAFETY LABORATORY

OIL SPILL IDENTIFICATION ANALYSES  
COST RECOVERY DOCUMENTATION

LABORATORY CASE NUMBER: 96-117

REQUESTOR: MARINE SAFETY OFFICE PUGET SOUND

UNIT CASE NUMBER: MC95015622

NUMBER OF SAMPLES: 05

COST PER SAMPLE PREPARED: \$20.00

TOTAL COSTS OF SAMPLE PREPARATION: \$100.00

NUMBER OF ANALYSES: 06

COST PER ANALYSIS: \$85.98

TOTAL COSTS FOR ANALYSIS: \$515.88

TOTAL COSTS: \$615.88

This documentation is provided for purposes of Phase IV - Documentation and Cost Recovery under the National Oil and Hazardous Substances Pollution Contingency Plan(40 CFR Part 300).

  
K. L. PLOURDE DATE: 16JAN96  
Commanding Officer



**OIL SPILL IDENTIFICATION SYSTEM (OIS)****RELEVANCE TO SPILL SOURCE DETERMINATION**

Petroleum is a complex mixture of thousands of different organic compounds formed from a variety of organic materials that are chemically converted under differing geological conditions over long periods of time. The infinitely variable nature of these factors results in distinct chemical differences between oils formed under dissimilar conditions and/or environments. While oil from one crude oil field is readily distinguishable from another, differences in the makeup of oils from the same crude oil field can sometimes be observed as well. Refined oils are fractions usually derived by distillation of crude oil. Two refined oils of the same type differ because of dissimilarities in the characteristics of their crude oil feed stocks as well as variations in refinery processes and any subsequent contact with other oils mixed in during transfer operation from residues in tanks, ships, pipes, hoses etc... Thus, all petroleum oils, to some extent have chemical compositions that differ from each other.

The characteristic properties of an oil can be explored by a variety of analytical methods. The results of analysis by any of these methods can be presented in graph form. In general, when the graphical data for two oils produced by a particular method are compared, the differences between the graphs reflect differences between the oils.

The OIS System, developed during the mid-1970s at the Coast Guard Research and Development Center, is based on a multi-method approach to "fingerprinting" oils. In 1978, the Central Oil Identification Laboratory (COIL) was established as the operating facility to implement the OIS. In 1988, COIL was renamed the Marine Safety Laboratories (MSL), though the acronym COIL is still widely used. OIS is designed to determine the unique, intrinsic chemical properties of oils via analytical techniques and establish whether or not a common source relationship exists between samples of spilled oil and samples of oil from a suspected source. Since 1978, MSL/COIL has analyzed over 39,000 samples, involving more than 5,700 spill cases, in support of oil pollution investigations.

**DATA PRODUCTION AND INTERPRETATION**

Oil sample preparation, testing and storage are conducted in accordance with American Society for Testing and Materials (ASTM) consensus standards. MSL/COIL currently utilizes three primary analytical techniques: Gas Chromatography (GC) (ASTM D-3328), Fluorescence Spectroscopy (FL) (ASTM D 3650), Infrared Spectroscopy (IR) (ASTM D-3414), and Gas Chromatography-Mass Spectrometry (GC-MS) (ASTM D-5739) that is used as a complementary analytical method. A rigorous laboratory quality assurance program monitors both instrument performance and sample preparation to ensure that data are accurate and reproducible.

All samples in a given case are initially analyzed by one method to determine the class of petroleum product. Samples can be excluded from further analysis based on results from the initial analysis. Further analyses are performed on samples which are potential matches to the source of the oil.

The Supervisor of Analysis interprets the data from all test methods performed and draws conclusions concerning whether or not certain spilled oil and suspected source samples were derived from the same chemical source. Data interpretation in oil spill source identification is non-trivial and fundamentally different from typical chemical analyses because the chemical properties of spilled oil are altered when oil is introduced into the environment. From the moment oil enters the environment, evaporation, dissolution, photochemical oxidation, biodegradation and other forces begin to alter the oil's characteristics or "fingerprint". These combined processes are termed weathering and can significantly complicate data interpretation. Contamination of the spilled oil with other oils or substances is another complicating factor. The experienced oil spill analyst is familiar with the complexities of the weathering processes and is able to distinguish real differences between two oils from those apparent differences resulting from weathering alterations. Interferences from contaminants can usually be recognized as such and discounted when weighing the test results. However, at times, severe weathering and/or contamination can mask many of the inherent differences between oils of a similar type.

#### REPORTING

The typical MSL/COIL OIS Report consists of four parts: case identifying information, a listing of analysis techniques performed, the results section and the conclusions section. The results section describes the types of petroleum observed in the samples provided, and comments on chemical similarities or dissimilarities between spill samples and/or between spill and suspected source samples. In all cases the Supervisor of Analysis bases the written results on interpretations from the aggregate of all data generated.

The conclusions section establishes whether or not a common source relationship exists between samples of spilled oil and samples of oil from a suspected source. There are two outcomes most frequently found in the conclusions section of the typical MSL/COIL OIS Report: "derived from a common source" and "not derived from a common source". However, to maintain the high degree of reliability for both "common source" and "not a common source" determinations, it is necessary to exclude some comparisons from these categories. Oil spill cases vary widely in possible explanations for why a determination could not be made. Instead of using only a statement of "inconclusive", the comments will concisely explain the reason for the outcome for each individual case. For example, some sources are highly inhomogeneous, and a sample of such a spill may not reflect the composition of the product remaining in such a source. The spill may contain very little oil, or it may be excessively weathered or contaminated. Of important note, MSL/COIL conclusions address chemical comparisons and not physical aspects of evidence. Additionally, chemical evidence provided in a MSL/COIL conclusion that is other than "common source" might still be used by the investigating officer, when combined with physical evidence to establish a preponderance of the evidence argument against an alleged responsible party.

MSL/COIL OIS Reports are submitted to Marine Safety Offices (MSO's) for inclusion, as chemical evidence, in Marine Violation/Casualty Reports. The outcomes in the conclusions section of the OIS Report define the nature of the chemical evidence provided. MSO personnel are advised to combine the chemical evidence provided in the MSL/COIL OIS Reports with physical and circumstantial evidence developed during the investigation when writing Marine Violation Reports. Inquiries challenging the technical content of MSL/COIL OIS Reports by representatives of the alleged responsible party should be handled at the Hearing Officer level. Explicit guidance describing the communications process between the Hearing Officer and the MSL/COIL Supervisor of Analysis on technical issues involving chemical evidence is given in Commandant (G-LMI) memorandum 16460 dated 26 January 1981.

#### PERSONNEL QUALIFICATIONS

MSL/COIL laboratory technicians performing sample preparation and testing are graduates of the Coast Guard Marine Science Technician School. Each MSL/COIL technician has successfully completed a comprehensive training program at the MSL/COIL facility. Additionally, many have received supplemental training at leading civilian institutions in their specialty area.

The Supervisor of Analysis monitors all aspects of the analysis, certifies and interprets the test results, and prepares the final MSL/COIL report. This individual is a professionally trained chemist experienced in oil spill source identification. Individuals currently qualified to perform this function are:

Lieutenant Commander Kristy L. Plourde, U.S. Coast Guard  
Commanding Officer  
B.S. Physical Sciences, 1983, US Coast Guard Academy  
M.S. Chemistry, 1989, University of Connecticut

Dr. Martha Hendrick  
Chemist  
B.A. Chemistry, 1969, Rhodes College  
M.A. Education, 1974, Stanford University  
Ph.D. Analytical Chemistry, 1985, University of Connecticut  
Chair, ASTM Subcommittee D19.31, Waterborne Oils

#### REFERENCES

A more technical description of the OIS is contained in Report CG-D-52-77 "Oil Spill Identification System", Final Report, June 1977, USCG R&D Center. This document is available through the National Technical Information Service, Springfield, VA 22161.

For information concerning the ASTM standards used in Oil Spill Identification, consult "Oil in the Environment", Martha S. Hendrick, Ph.D., ASTM Standardization News, April 1991.

For additional information regarding the applicability of the Coast Guard's OIS, see "Chemical Identification of Oil Spill Sources", Allen P. Bentz, Ph.D., The Forum, Volume XIII, Number 2, Winter 1978. Dr. Bentz is a research scientist at the Coast Guard Research and Development Center and a recognized expert in the field of oil spill source identification. He has been closely involved with most of the development work leading to the present state-of-the-art.

## **APPENDIX C**

Boring Logs, Monitoring Well Logs, and Test Pit Logs

## **Appendix B**

### **Lithologic Logs**

Elevation reference: Ground surface elevation:		Well completed: Casing elevation:						AS-BUILT DESIGN		TESTING
DEPTH (feet)	SOIL DESCRIPTION	SAMPLE TYPE	SAMPLE NUMBER	BLOW COUNTS	OVM READING	GROUND WATER	AS-BUILT DESIGN			
0	Inferred medium dense, moist, brown SILT with gravel and some sand. Slight odor noted.									
5	Inferred medium dense, moist, grey, SILT with some sand and gravel. Strong odor noted.					▼ ATD				
10	Inferred, medium dense, wet, grey, SILT with sand and organics. Strong odor noted.									
15	Inferred, dense, wet, dark grey, organics (wood and peat) with some sand and silt.									
Boring terminated at 18 feet.										
20										
25										
30										

**LEGEND**

▼  
ATD Observed groundwater level  
(ATD = at time of drilling)



**RITTENHOUSE-ZEMAN & ASSOCIATES, INC.**  
Environmental Consultants  
1400 140th Ave NE  
Bellevue, Washington 98005



SOIL DESCRIPTION	DEPTH (FEET)	LAB TESTS	SAMPLING	GROUND WATER	STANDARD PENETRATION RESISTANCE					
					▲ BLOWS PER FOOT (140 lb. hammer, 30 inch drop)					
Ground Surface Elevation Approximately Feet	0				0	10	20	30	40	50
Loose to medium dense, wet to saturated, gray and brown-gray, silty fine to coarse SAND with a trace of gravel and wood debris (Fill)	0 - 10		I	▽		▲				
Soft, saturated, brown, silty PEAT	10 - 11		I			▲				
Total depth 11 feet Boring completed 9 March 1988	11 - 40									

- SAMPLING**
- I 2' OD SPLIT SPOON SAMPLE
  - II 3' OD SHELBY SAMPLE
  - III 2.5' ID RING SAMPLE
  - BULK SAMPLE
  - \* SAMPLE NOT RECOVERED

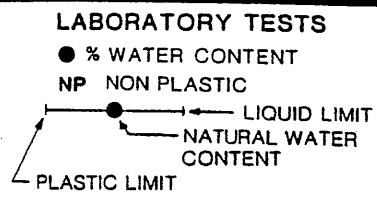
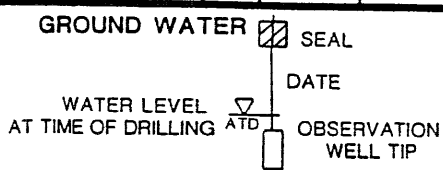

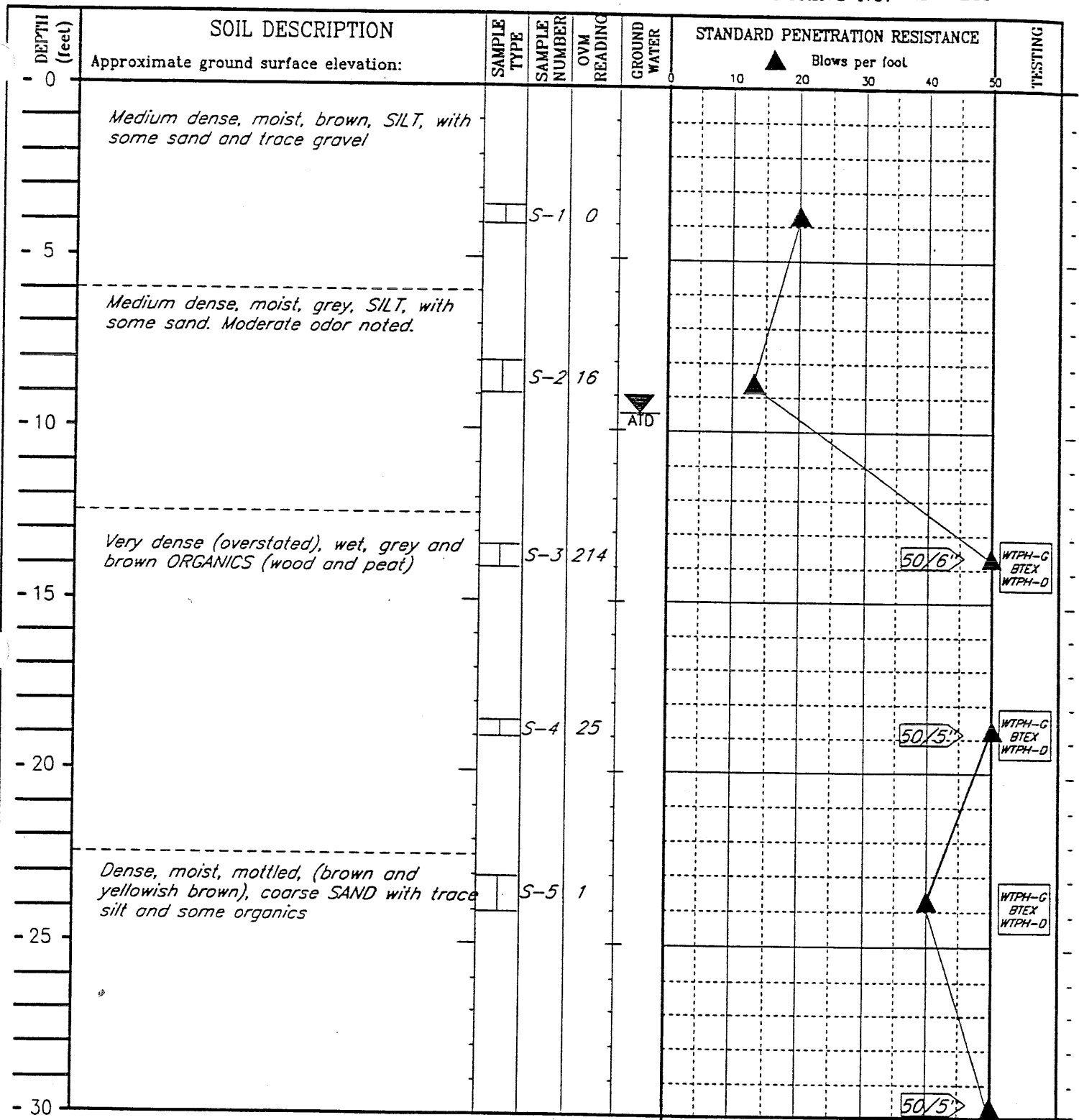

LEGEND

I 2-inch OD split-spoon sample

▽ Groundwater level at time of drilling

WTPH-G  
BTEX  
WTPH-D Soil analyses method

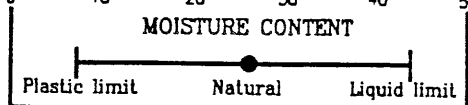

**RITTENHOUSE-ZEMAN & ASSOCIATES, INC.**  
 Geotechnical & Environmental Consultants  
 1400 140th Ave NE  
 Bellevue, Washington 98005



DEPTH (feet)	SOIL DESCRIPTION	SAMPLE TYPE	SAMPLE NUMBER	OVM READING	GROUND WATER	STANDARD PENETRATION RESISTANCE					TESTING	
						Blows per foot						
0	Approximate ground surface elevation:					0	10	20	30	40	50	
	<i>Boring terminated at approximately 31 feet</i>		<i>S-6</i>	<i>0</i>								
-5												
-10												
-15												
-20												
-25				<i>1</i>								
-30												

LEGEND

 2-inch OD split-spoon sample

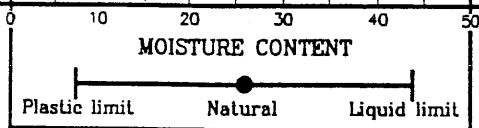

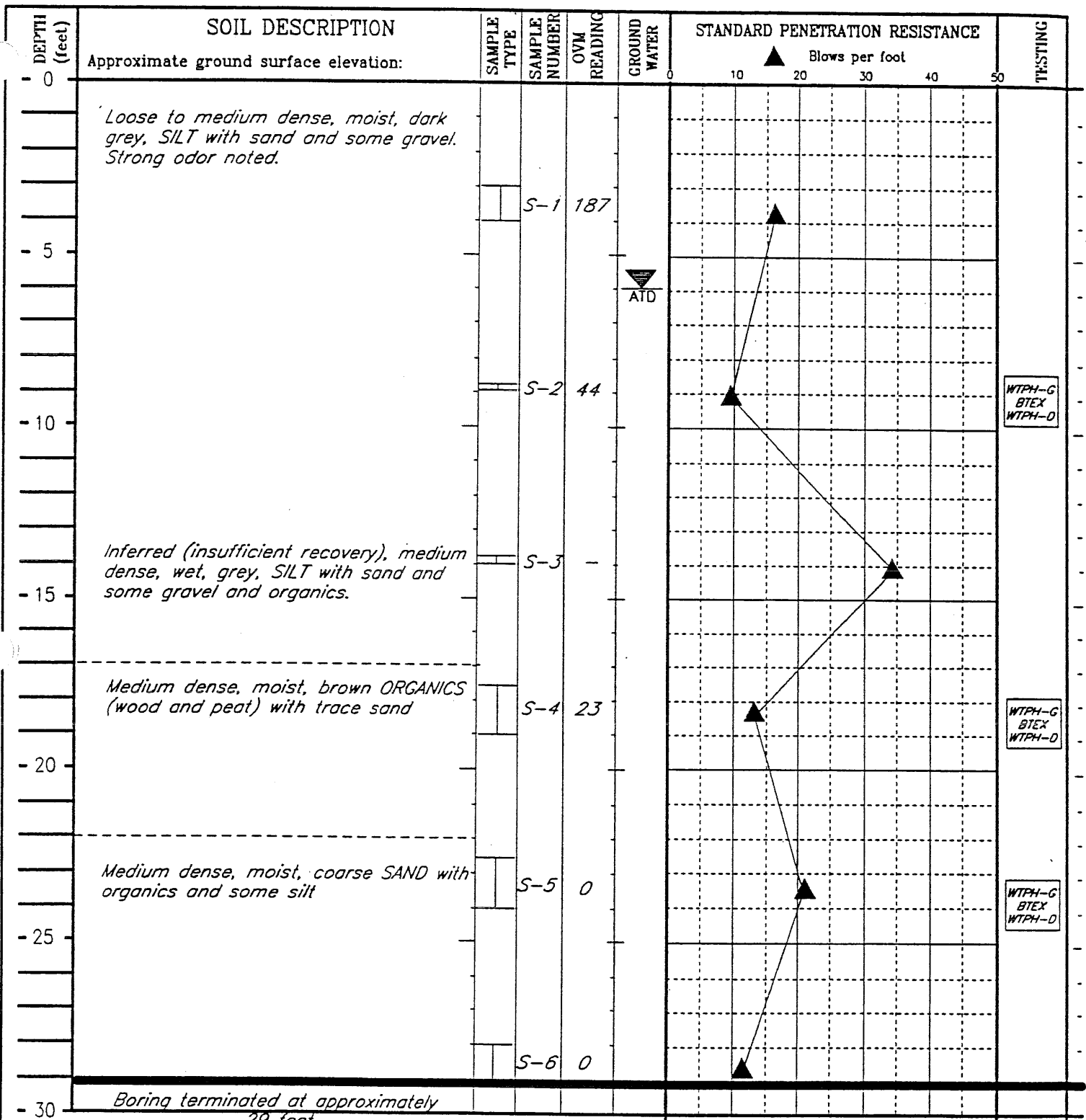

**RITTENHOUSE-ZEMAN & ASSOCIATES, INC.**  
*Geotechnical & Environmental Consultants*  
 1400 140th Ave NE  
 Bellevue, Washington 98005



**LEGEND**

 2-inch OD split-spoon sample

 Groundwater level at time of drilling

 Soil analyses method

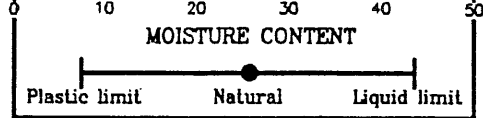

**RITTENHOUSE-ZEMAN & ASSOCIATES, INC.**  
*Geotechnical & Environmental Consultants*  
 1400 140Lb Ave NE  
 Bellevue, Washington 98005

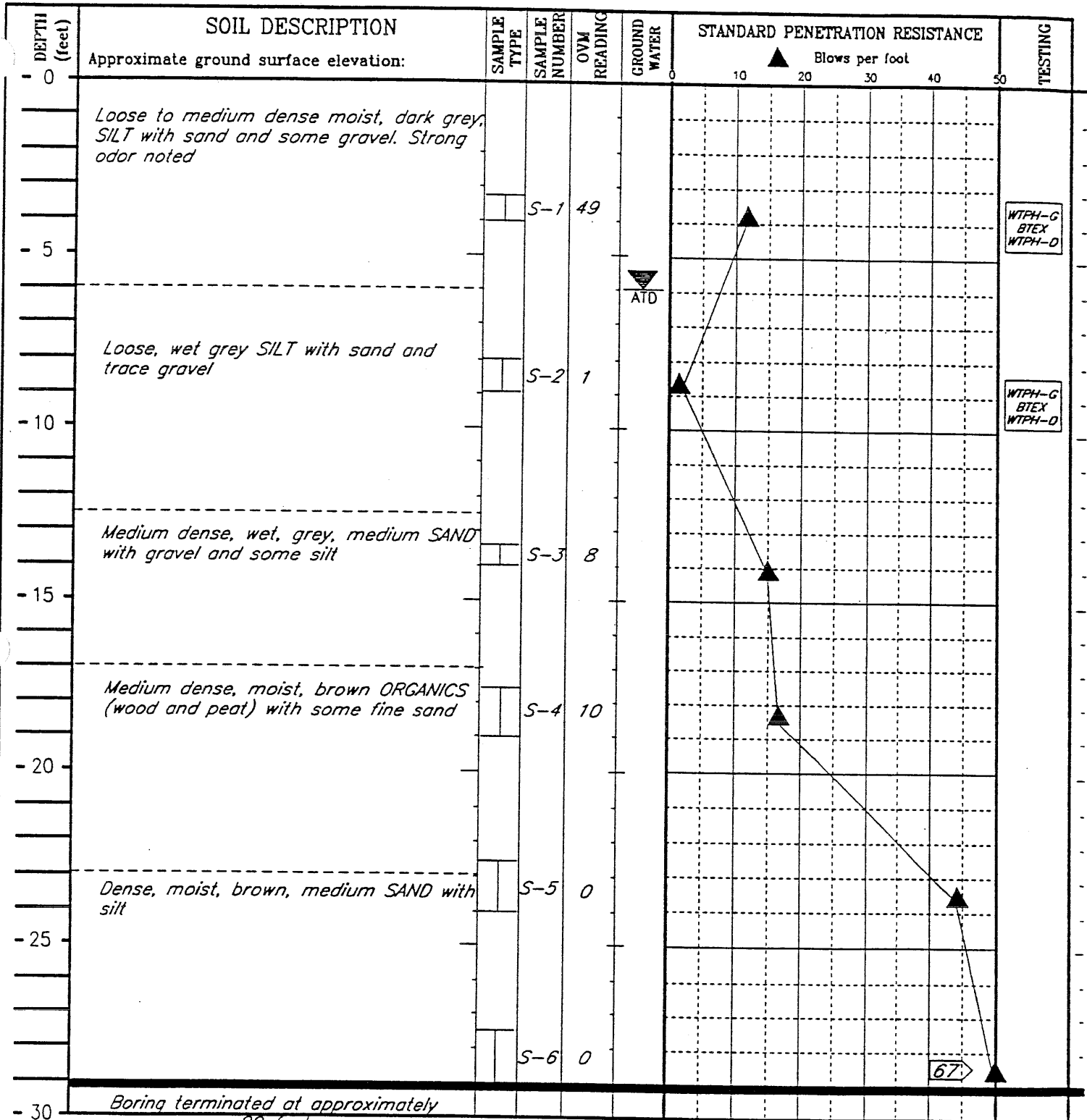

**LEGEND**

I 2-inch OD split-spoon sample

▼ Groundwater level at time of drilling  
ATD

WTPH-G  
BTEX  
WTPH-D  
Soil analyses method

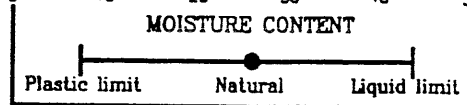

**RITTENHOUSE-ZEMAN & ASSOCIATES, INC.**  
Geotechnical & Environmental Consultants  
1400 140th Ave NE  
Bellevue, Washington 98005

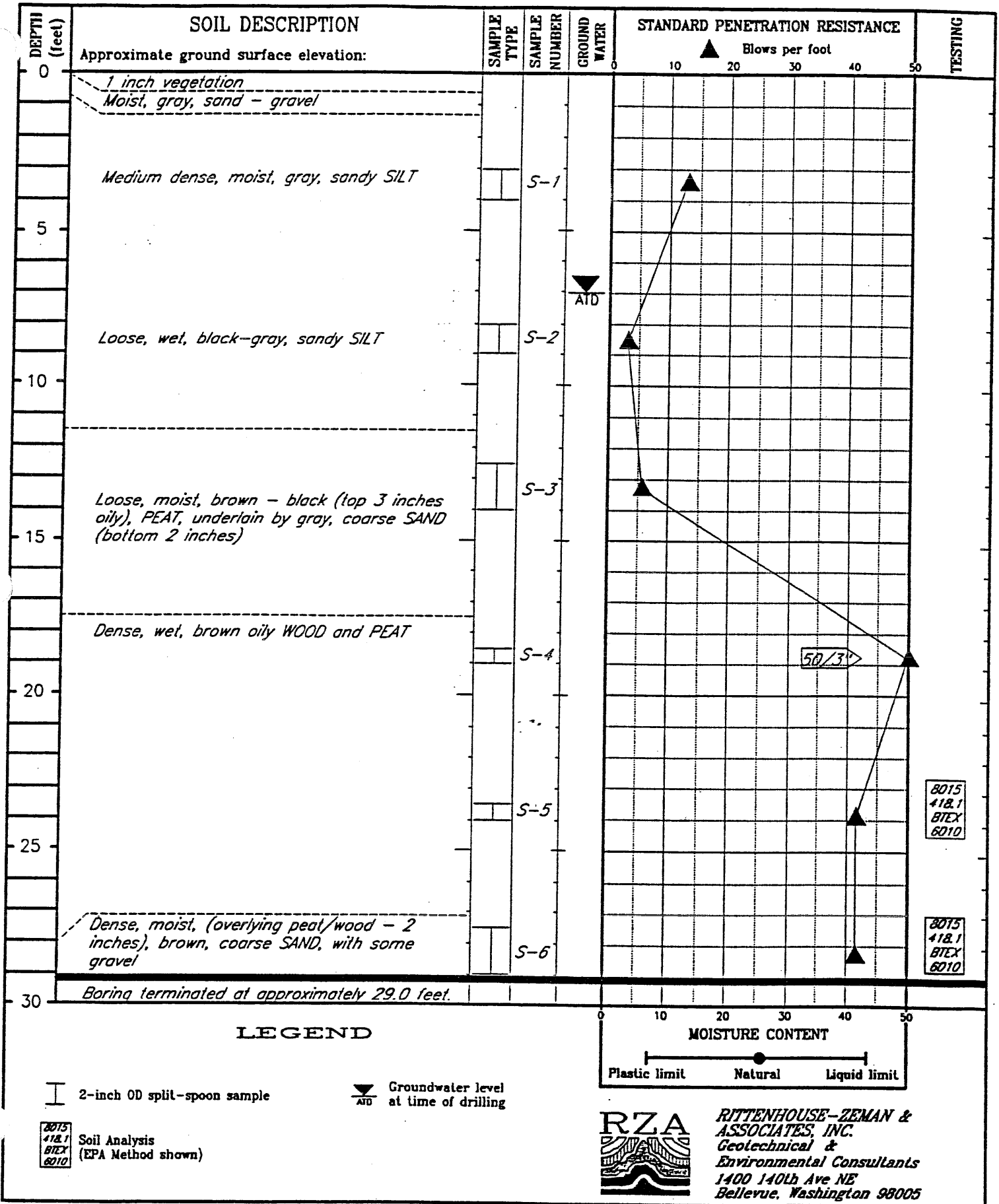

PROJECT: *Everett Mobil Bulk Plant* W.O. 11-04558-04 WELL NO. B-34

Elevation reference: N/A Well completed: N/A  
 Ground surface elevation: N/A Casing elevation: N/A

AS-BUILT DESIGN

Page 1 of 1

DEPTH (feet)	SOIL DESCRIPTION	SAMPLE TYPE	SAMPLE NUMBER	BLOW COUNTS	OVM READING	GROUND WATER	TESTING
0							
	<i>Loose, moist, brown, silty, fine to medium SAND interbedded with gray, sandy SILT with trace gravel</i>		S-1	5	17		<i>Boring abandoned by backfilling with bentonite.</i>
			S-2		69		
5			S-3			▼ ATD	
	<i>Medium dense to dense, saturated, gray, silty, fine to medium SAND with some wood debris</i>		S-4	41	80		
10	<i>Grades to grayish-black, silty, medium to coarse SAND</i>		S-5	12			
15	<i>Bottom of boring at 14 feet. Petroleum-like staining and odor observed in all samples. Field FT-IR analysis of sample S-5 indicated &gt; 10,000 ppm TPH.</i>						
20							
25							
30							

LEGEND

 2-inch O.D. split spoon sample

 Observed groundwater level  
 ATD = at time of drilling

 3-inch OD Shelby sampler

**RZA AGRA, Inc.**  
 Geotechnical & Environmental Group

11335 NE 122nd Way, Suite 100  
 Kirkland, Washington 98034-6918

## Bobcat Boring Logs

### BB-1

Gray, moist to wet, silty, gravelly SAND with some cobbles. Slow seepage at approximately 1.0 foot; no other seepage encountered; soil exhibits a petroleum hydrocarbon-like odor. No LPH observed. Met with refusal at approximately 3.0 feet.

### BB-2

Gray, moist to wet, gravelly SAND. Slow seepage at approximately 1.5 feet; no other seepage encountered; soil exhibits a petroleum hydrocarbon-like odor. Seepage from 1.5 foot depth pooled at bottom of boring and exhibits an iridescent sheen. No LPH observed. Boring terminated at a depth of approximately 4.0 feet.

### BB-3

Gray, moist to wet, gravelly SAND with some gravel. Slow seepage below approximately 2.5 feet; soil exhibits a petroleum hydrocarbon-like odor. Discontinuous blebs of LPH observed on water pooled at the bottom of the boring. Boring terminated at a depth of approximately 4.0 feet. Boring allowed to remain open approximately two hours; discontinuous blebs of LPH still present on the water pooled in the bottom of the boring.

### BB-4

Gray, moist to wet, silty, gravelly SAND with some wood debris. Slow seepage at approximately 1.0 foot; soil exhibits a petroleum hydrocarbon-like odor. Moderate seepage observed below approximately 3.5 feet. Approximately 0.01 to 0.02 feet of LPH accumulated on groundwater in the boring. Boring terminated at a depth of approximately 4.0 feet.

### BB-5

Dark gray, wet, SAND with some silt, gravel, and wood debris. Moderate seepage observed below approximately 3.0 feet; soil exhibits a petroleum hydrocarbon-like odor. Boring terminated at a depth of approximately 4.0 feet; caved to approximately 3.5 feet. Gauged fluid at bottom of boring using Colorcut paste; it appeared to be 100% LPH. Collected two bottles of LPH for potential future laboratory analysis; collected one bag sample of soil for possible sieve analysis.

### BB-6

Gray, moist to wet, gravelly, SAND with some silt. LPH seepage observed at approximately 3.8 feet; soil exhibits a petroleum hydrocarbon-like odor. Boring terminated at a depth of approximately 4.0 feet. Gauged fluid at bottom of boring using Colorcut paste; it appeared to be 100% LPH.

### BB-7

Gray, moist to wet, gravelly, SAND with some silt and wood debris. Slow water and LPH seepage observed at approximately 1.0 feet; rapid LPH seepage observed below approximately 3.5 feet; soil exhibits a petroleum hydrocarbon-like odor. Boring terminated at a depth of approximately 4.0 feet. Gauged fluid at bottom of boring using Colorcut paste; it appeared to be 100% LPH.

**BB-8**

Gray, moist to wet, gravelly SAND with some silt; scattered glass shards. LPH observed on tip of auger at approximately 2.5 feet. Slow seepage observed below approximately 3.8 feet; soil exhibits a petroleum hydrocarbon-like odor. Boring terminated at a depth of approximately 4.0 feet. Gauged fluid at bottom of boring using Colorcut paste approximately one hour after drilling boring; LPH thickness approximately 0.05 feet.

**BB-9**

Gray, moist to wet, gravelly SAND with some silt. Slow seepage observed at approximately 1.5 feet. Slow seepage observed again below approximately 3.8 feet; soil exhibits a petroleum hydrocarbon-like odor. Boring terminated at a depth of approximately 4.0 feet. Gauged fluid at bottom of boring using Colorcut paste; fluid appears to be a mixture of LPH and water (stains tape black like LPH but changes Colorcut from yellow to red like water).

**BB-10**

Gray, moist to wet, gravelly SAND with some silt and cobbles. No seepage observed; soil exhibits a petroleum hydrocarbon-like odor. Boring terminated at a depth of approximately 4.0 feet.

**BB-11**

Gray, moist to wet, gravelly SAND with some silt. No seepage observed in boring but soil and auger tip appears to be saturated with water; no LPH observed. Soil exhibits a petroleum hydrocarbon-like odor. Boring terminated at a depth of approximately 4.0 feet. Boring left open overnight. Fluid level in boring in 5/23/96 was at approximately 3.0 feet. Gauged fluid with Colorcut paste; LPH thickness measured in boring using this method was approximately four inches. Collected two bottles of LPH for potential future laboratory analysis; collected one bag sample of soil for possible sieve analysis.

**BB-12**

Gray, wet, gravelly SAND with some silt. Rapid seepage observed below approximately 3.0 feet; soil exhibits a petroleum hydrocarbon-like odor. Boring terminated at a depth of approximately 4.0 feet. Seepage accumulated in the boring to a depth of approximately 2.0 feet. Gauged fluid at bottom of boring using Colorcut paste; LPH thickness approximately 0.01 feet. Collected two bottles of LPH for potential future laboratory analysis.

**BB-13**

Gray, moist, gravelly SAND overlying saturated  $\frac{3}{4}$ -inch minus round rock at approximately 2.0 feet. LPH on tip of auger when removed from the boring. However, boring caved as fast as the auger was removed; consequently, LPH thickness was indeterminate; soil exhibits a petroleum hydrocarbon-like odor. Boring terminated at a depth of approximately 4.0 feet.

**BB-14**

Gray, moist, gravelly SAND with some silt and scattered metal debris. No seepage observed; soil exhibits a petroleum hydrocarbon-like odor. Boring terminated at a depth of approximately 4.0 feet.

LOG OF  
EXPLORATORY BORING

Project No: 05-487-002      Boring No: W-1  
 Date: 2-23-90  
 Client: American Distributing Co      Driller: Geotech  
 Location: Bulk Terminal-Everett,      Drilling Method: CMEC-55  
 Hollow Stem Auger  
 Logged by: G. Stuesse      Hole Diameter: 7"  
 Installation Data: (See Below)      Page No: 1 of 1

Location of boring:

Depth (ft)	Graphic Log	Blow/ft	Vapor Concentration (ppm)	Sample type and Depth	Soil Group Symbol (U.S.C.S.)	Water Level	Time:	Date:	Comments:				
0 -		4.00		Ring @ 3.0'	Pt	0-3.0" Asphalt			3.0' Organic debris, silty, brown, loose, moist, primarily wood shavings, slight organic odor				
2 -													
4 -													
6 -													
8 -													
10 -													
10.0'						10.0' Silt, brown, soft, wet, wood shavings, slight odor.				ML			
15.0'						15.0' Silt, brown, soft, wet, wood shavings, slight petroleum sheen on cuttings.				ML			
20 -													
23.0'						TD=23.0'							
						Installation Data:							
						Screen: 23.0' - 3.0'							
						Blank: 3.0' - 0							
						Sand: 23.0' - 2.0'							
						Bentonite: 2.0' - 1.0'							
						Concrete: 1.0' - 0							



**LOG OF  
EXPLORATORY BORING**

Project No: 05-487-002      Boring No: W-2  
 Date: 2-22-90  
 Client: American Distributing Co      Driller: Geotech  
 Location: Bulk Terminal-Everett,      Drilling Method: CMEC-55  
    Hollow Stem Auger  
 Logged by: G. Stuesse      Hole Diameter: 7"  
 Installation Data: (See Below)      Page No: 1 of 1

Location of boring:

Depth (ft)	Graphic Log	Blow/ft	Vapor Concentration (ppm)	Sample type and Depth	Soil Group Symbol (U.S.C.S.)	Water Level	Time:	Date:	Comments:
0 -		11	TIP II 60	Ring @ 3.0'	-----				0-3" Gravel; degraded asphalt.
2 -					SW	3-5" Sand, fine-coarse, grey, loose, very moist, occasional fine gravel, slight-moderate oily odor, dark brown, oily film on outside of sampler.			
4 -					SW	5.0' Sand, fine-coarse, grey, loose, wet, occasional fine gravel, slight, moderate oily, odor, dark brown oily film on outside of sampler.			
6 -					SW	15.0' Sand, fine-coarse, grey, loose, wet, occasional coarse gravel, slight-medium oily odor, dark brown oily film on outside of sampler.			
8 -					SW	20.0' Sand, fine coarse, grey, loose, wet, occasional coarse gravel, slight-medium oily odor, dark brown oily film on outside of sampler.			
10 -					OL	23.0' Clay, brown, soft, wet, possible organic, very slight organic odor.			
12 -									
14 -									
16 -									
18 -									
20 -									
22 -									
24 -									
26 -									
28 -									
30 -									
32 -									
34 -									
36 -									
38 -									
40 -									
42 -									
44 -									
46 -									
48 -									
50 -									
52 -									
54 -									
56 -									
58 -									
60 -									
62 -									
64 -									
66 -									
68 -									
70 -									
72 -									
74 -									
76 -									
78 -									
80 -									
82 -									
84 -									
86 -									
88 -									
90 -									
92 -									
94 -									
96 -									
98 -									
100 -									

Installation Data:  
 Screen: 23.0' - 3.0'  
 Blank: 3.0' - 0'  
 Sand: 23.0' - 2.0'  
 Bentonite: 2.0' - 1.0'  
 Concrete: 1.0' - 0'

NOTE: The lower 3.0' of well could not be sand packed due to heaving sands.

LOG OF  
EXPLORATORY BORING

Project No: 05-487-002      Boring No: W-3  
 Date: 2-22-90  
 Client: American Distributing Co      Driller: Geotech  
 Location: Bulk Terminal-Everett,      Drilling Method: CMEC-55  
 Hollow Stem Auger  
 Logged by: G. Stuesse      Hole Diameter: 7"  
 Installation Data: (See Below)      Page No: 1 of 1

Location of boring:

Depth (ft)	Graphic Log	Blow/ft	Vapor Concentration (ppm)	Sample type and Depth	Soil Group Symbol (U.S.C.S.)	Water Level	Time:	Date:	Comments:
0 -		11		Ring @ 3.0'	SP				0-3" Asphalt
2 -									3.0' Sand, slight silty, fine-medium, grey, loose, moist, occasional gravel, no odor.
4 -									7.0' Sand, slight silty, fine-medium, grey, loose, wet, occasional gravel, no odor.
6 -									
8 -									15.0' Sand, slight silty, fine-medium, grey, loose, wet, occasional gravel, no odor.
10 -									
12 -									
14 -									
16 -									
18 -									
20 -									20.0' Sand, slight silty, fine-medium, grey, loose, wet, occasional gravel, no odor.
22 -									
23.0 -	TD=23.0'								NOTE: Vapors from well have H2S odor.
									Installation Data: Screen: 23.0' - 3.0' Blank: 3.0' - 0' Sand: 23.0' - 2.0' Bentonite: 2.0' - 1.0' Concrete: 1.0' - 0'

LOG OF  
EXPLORATORY BORING

Project No: 05-487-003

Boring No: W-4

Date: 2/22/90

Client: American Distributing Co.

Driller:

Location: Bulk Terminal

Drilling Method:

Everett, WA

Hole Diameter: 7"

Logged By:

Page No: 1 of 1

Installation Data: See Below

Location of boring:

Depth (ft)	Graphic Log	Blow/ft	Vapor Concentration (ppm)	Sample type and Depth	Soil Group Symbol (U.S.C.S.)	Water Level	Time	Date	Comments:
0 -		16	0	Ring @ 4'	SM				0 - 3" Concreta.
2 -									@ 4' Sand, silty, fine to medium grained, gray/brown, loose, wet, moderate odor, film of brown oil on sampler.
4 -									@ 10' Sand, silty, fine to medium grained, gray/brown, loose, wet, moderate odor, pieces of glass, metal and wood.
6 -									@ 15' Clay, organic, brown, soft, wet, pieces of wood, very slight odor.
8 -									
10 -									
12 -									
14 -									
16 -									
18 -									
20 -									@ 20' Clay, organic, brown, soft, wet, pieces of wood, very slight odor.
22 -									
24 -									
26 -									
28 -									
30 -									
32 -									
34 -									
36 -									
38 -									
40 -									
42 -									
44 -									
46 -									
48 -									
50 -									
52 -									
54 -									
56 -									
58 -									
60 -									
62 -									
64 -									
66 -									
68 -									
70 -									
72 -									
74 -									
76 -									
78 -									
80 -									
82 -									
84 -									
86 -									
88 -									
90 -									
92 -									
94 -									
96 -									
98 -									
100 -									
102 -									
104 -									
106 -									
108 -									
110 -									
112 -									
114 -									
116 -									
118 -									
120 -									
122 -									
124 -									
126 -									
128 -									
130 -									
132 -									
134 -									
136 -									
138 -									
140 -									
142 -									
144 -									
146 -									
148 -									
150 -									
152 -									
154 -									
156 -									
158 -									
160 -									
162 -									
164 -									
166 -									
168 -									
170 -									
172 -									
174 -									
176 -									
178 -									
180 -									
182 -									
184 -									
186 -									
188 -									
190 -									
192 -									
194 -									
196 -									
198 -									
200 -									
202 -									
204 -									
206 -									
208 -									
210 -									
212 -									
214 -									
216 -									
218 -									
220 -									
222 -									
224 -									
226 -									
228 -									
230 -									
232 -									
234 -									
236 -									
238 -									
240 -									
242 -									
244 -									
246 -									
248 -									
250 -									
252 -									
254 -									
256 -									
258 -									
260 -									
262 -									
264 -									
266 -									
268 -									
270 -									
272 -									
274 -									
276 -									
278 -									
280 -									
282 -									
284 -									
286 -									
288 -									
290 -									
292 -									
294 -									
296 -									
298 -									
300 -									
302 -									
304 -									
306 -									
308 -									
310 -									
312 -									
314 -									
316 -									
318 -									
320 -									
322 -									
324 -									
326 -									
328 -									
330 -									
332 -									
334 -									
336 -									
338 -									
340 -									
342 -									
344 -									
346 -									
348 -									
350 -									
352 -									
354 -									
356 -									
358 -									
360 -									
362 -									
364 -									
366 -									
368 -									
370 -									
372 -									
374 -									
376 -									
378 -									
380 -									
382 -									
384 -									
386 -									
388 -									
390 -									
392 -									
394 -									
396 -									
398 -									
400 -									
402 -									
404 -									
406 -									
408 -									
410 -									
412 -									
414 -									
416 -									
418 -									
420 -									
422 -									
424 -									
426 -									
428 -									
430 -									
432 -									
434 -									
436 -									
438 -									
440 -									
442 -									
444 -									
446 -									
448 -									
450 -									
452 -									
454 -									
456 -									
458 -									
460 -									
462 -									
464 -									
466 -									
468 -									
470 -									
472 -									
474 -									
476 -									
478 -									
480 -									
482 -									
484 -									
486 -									
488 -									
490 -									
492 -									
494 -									
496 -									
498 -									
500 -									
502 -									
504 -									
506 -									
508 -									
510 -									
512 -									
514 -									
516 -									
518 -									
520 -									
522 -									
524 -									
526 -									
528 -									
530 -									
532 -									
534 -									
536 -									
538 -									
540 -									
542 -									
544 -									
546 -									
548 -									
550 -									
552 -									
554 -									
556 -									
558 -									
560 -									
562 -									
564 -									
566 -									
568 -									
570 -									
572 -									
574 -									
576 -									
578 -									
580 -									
582 -									
584 -									
586 -									
588 -									
590 -									
592 -									
594 -									
596 -									
598 -									
600 -									
602 -									
604 -									
606 -									
608 -									
610 -									
612 -									
614 -									
616 -									
618 -									
620 -									
622 -									
624 -									
626 -									
628 -									
630 -									
632 -									
634 -									
636 -									
638 -									
640 -									
642 -									
644 -									
646 -									
648 -									
650 -									
652 -									
654 -									
656 -									
658 -									
660 -									
662 -									
664 -									
666 -									
668 -									
670 -									
672 -									
674 -									
676 -									
678 -									
680 -									
682 -									
684 -									
686 -									
688 -									
690 -									
692 -									
694 -									
696 -									
698 -									
700 -									
702 -									
704 -									
706 -									
708 -									
710 -									
712 -									
714 -									
716 -									
718 -									
720 -									
722 -									
724 -									
726 -									
728 -									
730 -									
732 -									
734 -									
736 -									
738 -									
740 -									
742 -									
744 -									
746 -									
748 -									
750 -									
752 -									
754 -									
756 -									
758 -									
760 -									
762 -									
764 -									
766 -									
768 -									
770 -									
772 -									
774 -									
776 -									
778 -									
780 -									
782 -									
784 -									
786 -									
788 -									
790 -									
792 -									
794 -									
796 -									
798 -									
800 -									
802 -									
804 -									
806 -									
808 -									
810 -									
812 -									
814 -									
816 -									
818 -									
820 -									
822 -									
824 -									
826 -									
828 -									
830 -									
832 -									
834 -									
836 -									
838 -									
840 -									
842 -									
844 -									
846 -									
848 -									
850 -									
852 -									
854 -									
856 -									
858 -									
860 -									
862 -									
864 -									
866 -									
868 -									
870 -									
872 -									
874 -									
876 -									
878 -									
880 -									
882 -									
884 -									
886 -									
888 -									
890 -									
892 -									
894 -									
896 -									
898 -									
900 -									
902 -									
904 -									
906 -									
908 -									
910 -									
912 -									
914 -									
916 -									
918 -									
920 -									
922 -									
924 -									
926 -									
928 -									
930 -									
932 -									
934 -									
936 -									
938 -									
940 -									
942 -									
944 -									
946 -									
948 -									
950 -									
952 -									
954 -									
956 -									
958 -									
960 -									
962 -									
964 -									
966 -									
968 -									
970 -									
972 -									
974 -									
976 -									
978 -									
980 -									
982 -									
984 -									
986 -									
988 -									
990 -									
992 -									
994 -									
996 -									
998 -									
1000 -									
1002 -									
1004 -									
1006 -									
1008 -									
1010 -									
1012 -									
1014 -									
1016 -									
1018 -									
1020 -									
1022 -									
1024 -									
1026 -									
1028 -									
1030 -									
1032 -									

**LOG OF  
EXPLORATORY BORING**

Project No: 05-487-003      Boring No: W-5  
 Date: 2/22/90  
 Client: American Distributing Co.      Driller:  
 Location: Bulk Terminal      Drilling Method:  
 Everett, WA      Hole Diameter: 7"  
 Logged By:      Page No: 1 of 1  
 Installation Data: See Below

location of boring:

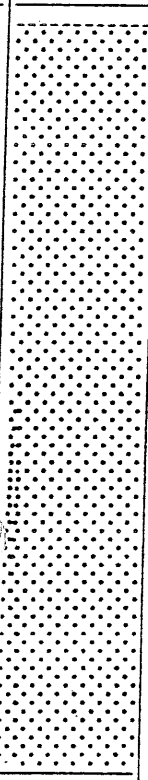
Depth (ft)	Graphic Log	Blow/ft	Vapor Concentration (ppm)	Sample type and Depth	Soil Group Symbol (U.S.C.S.)	Water Level	Time	Date	Comments:					
0 -		28	50	Ring @ 3'	SP				0 - 6" Gravel.					
2 -						@ 3' Sand, fine to medium grained, slightly silty, gray, loose, moist, slight odor, pieces of wood and metal.								
4 -						@ 6' Sand, fine to medium grained, slightly silty, gray, loose, wet, slight odor, film of brown oil on cuttings.								
6 -														
8 -														
10 -														
12 -														
14 -														
16 -														
18 -														
20 -														
22 -														
23 -														
TD=23'														
														Installation Data: Screen 23' - 3'
														Blank 3' - 0'
														Sand 23' - 2'
														Bentonite 2' - 1'
														Concrete 1' - 0'





LOG OF  
EXPLORATORY BORING

Project No: 05-487-003

Boring No: W-8

Date: 6/28/90

Client: American Distributing Co.

Driller: ESE

Location: Bulk Terminal

Drilling Method: Hand Auger

Everett, WA

Hole Diameter: 4"

Logged By: G. Stuesse

Page No: 1 of 1

Installation Data: See Below

Location of boring:

Depth (ft)	Graphic Log	Blow/ft	Vapor Concentration (ppm)	Sample type and Depth	Soil Group Symbol (U.S.C.S.)	Water Level	Time	Date	Comments:
0 -					SM				0 - 3' Sand, silty, brown, loose, moist to wet, no odor.
-									@ 3' - 10' Silt, gray, soft, wet, slight odor.
2 -									
-									
4 -						ML			
-									
6 -									
-									
8 -									
0									
	TD=10'					Installation Data: Screen 10' - 2' Blank 2' - 0' Sand 10' - 1' Bentonite 1' - .5' Concrete .5' - 0'			

LOG OF  
EXPLORATORY BORING

location of boring:

Project No: 05-487-003

Boring No: W-9

Date: 6/28/90

Client: American Distributing Co.

Driller:

Location: Bulk Terminal

Drilling Method: Hand Auger

Everett, WA

Hole Diameter: 7"

Logged By:

Page No: 1 of 1

Installation Data: See Below

Depth (ft)	Graphic Log	Blow/ft	Vapor Concentration (ppm)	Sample type and Depth	Soil Group Symbol (U.S.C.S.)	Water Level	Time	Date	Comments:
0 -					ML				0 - 3' Silt, sandy, brown, moist, no odor.
-									@ 3' - 7.5' Silt, gray, wet, moderate odor.
2 -									
-									
4 -									
-									
6 -									
-									
8 -	TD=7.5'								Installation Data: Screen 7.5' - 1.5'
-									Blank 1.5' - 0
-									Sand 7.5' - 1.0'
-									Bentonite 1.0' - 0.5'
-									Concrete 0.5' - 0





LOG OF  
EXPLORATORY BORING

Project No: 05-487-003

Boring No: W-11

Date: 6/28/90

Client: American Distributing Co.

Driller:

Location: Bulk Terminal

Drilling Method: Hand Auger

Everett, WA

Hole Diameter: 7"

Logged By:

Page No: 1 of 1

Installation Data: See Below

Location of boring:

Depth (ft)	Graphic Log	Blow/ft	Vapor Concen- tration (ppm)	Sample type and Depth	Soil Group Symbol (U.S.C.S.)	Water Level	Time	Date	Comments:	
0 -					Pt				0 - 2' Peat, silty, brown, moist, no odor. @ 2' - 6.5' Peat, brown, wet, brown, oil sheen.	
-										
2 -										
-										
4 -										
6 -										
-	TD=6.5'					Installation Data: Screen 6.5' - 1.5'				
-						Blank 1.5' - 0				
-						Sand 6.5' - 1.0'				
-						Bentonite 1.0' - 0.5'				
-						Concrete 0.5' - 0				

LOG OF  
EXPLORATORY BORING

Project No: 05-487-003

Boring No: W-12

Date: 6/28/90

Client: American Distributing Co.

Driller:

Location: Bulk Terminal  
Everett, WA

Drilling Method: Hand Auger

Hole Diameter: 7"

Logged By:

Page No: 1 of 1

Installation Data: See Below

location of boring:

Depth (ft)	Graphic Log	Blow/ft	Vapor Concentration (ppm)	Sample type and Depth	Soil Group Symbol (U.S.C.S.)	Water Level	Time	Date	Comments:
0 -					SM				0 - 3' Sand, silty, brown, moist, no odor.
2 -					Pt				@ 3' - 7.5' Peat, silty, brown, wet, slight odor.
4 -									
6 -									
8 -	TD=7.5'								Installation Data: Screen 7.5' - 1.5' Blank 1.5' - 0' Sand 7.5' - 1.0' Bentonite 1.0' - 0.5' Concrete 0.5' - 0'

LOG OF  
EXPLORATORY BORING

Project No: 05-487-003

Boring No: W-13

Date: 6/28/90

Client: American Distributing Co.

Driller:

Location: Bulk Terminal  
Everett, WA

Drilling Method: Hand Auger

Hole Diameter: 7"

Logged By:

Page No: 1 of 1

Installation Data: See Below

ield location of boring:

epth (ft)	Graphic Log	Blow/ft	Vapor Concen- tration (ppm)	Sample type and Depth	Soil Group Symbol (U.S.C.S.)	Water Level	Time	Date	Comments:	
0 -					ML				0 - 4' Silt, some sand and gravel, brown, moist, occasional cobbles, no odor.	
2 -										4' - 7' Silt, some sand and gravel, brown, moist, occasional cobbles, no odor.
4 -										
6 -										
8 -		TD=7'								Installation Data: Screen 7' - 2'
										Blank 2' - 0
										Sand 7' - 1'
									Bentonite 1' - .5'	
									Concrete .5' - 0	

LOG OF  
EXPLORATORY BORING

Project No: 05-487-003

Boring No: W-14

Date: 6/28/90

Client: American Distributing Co.

Driller:

Location: Bulk Terminal  
Everett, WA

Drilling Method: Hand Auger

Hole Diameter: 7"

Logged By:

Page No: 1 of 1

Installation Data: See Below

Location of boring:

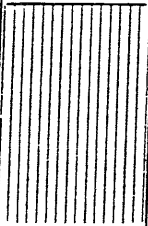
Depth (ft)	Graphic Log	Blow/ft	Vapor Concentration (ppm)	Sample type and Depth	Soil Group Symbol (U.S.C.S.)	Water Level	Time	Date	Comments:
0 -					ML				0 - 6.5' Silt, sandy, moist to wet, very slight odor.  Installation Data: Screen 6.5' - 2.0' Blank 2.0' - 0' Sand 6.5' - 1.0' Bentonite 1.0' - 0.5' Concrete 0.5' - 0'
-									
2 -									
4 -									
5 -		TD=6.5'							

LOG OF  
EXPLORATORY BORING

Project No: 05-487-003

Boring No: W-15

Date: 6/28/90

Client: American Distributing Co.

Driller:

Location: Bulk Terminal  
Everett, WA

Drilling Method: Hand Auger

Hole Diameter: 7"

Logged By:

Page No: 1 of 1

Installation Data: See Below

location of boring:

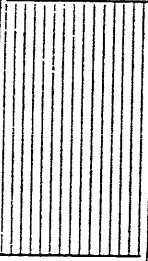
epth (ft)	Graphic Log	Blow/ft	Vapor Concen- tration (ppm)	Sample type and Depth	Soil Group Symbol (U.S.C.S.)	Water Level	Time	Date	Comments:
0 -									0 - 7' Silt, some sand and cobbles, moist to wet, slight odor.  Installation Data: Screen 6.0' - 1.5' Blank 1.5' - 0' Sand 6.0' - 1.0' Bentonite 1.0' - 0.5' Concrete 0.5' - 0'
2 -				ML					
4 -									
6 -									
8 -		TD=7'							
-									
-									
-									

LOG OF  
EXPLORATORY BORING

Project No: 05-487-003

Boring No: W-16

Date: 6/28/90

Client: American Distributing Co.

Driller:

Location: Bulk Terminal  
Everett, WA

Drilling Method: Band Auger

Hole Diameter: 7"

Logged By:

Page No: 1 of 1

Installation Data: See Below

Location of boring:

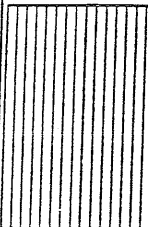
Depth (ft)	Graphic Log	Blow/ft	Vapor Concen- tration (ppm)	Sample type and Depth	Soil Group Symbol (U.S.C.S.)	Water Level	Time	Date	Comments:	
0 -					ML				0 - 6' Silt, some sand and gravel, moist to wet, occasional cobbles, oil on ground water surface.	
-										
2 -										
-										
4 -										
6 -										
8 -						Installation Data: Screen 6' - 2'				
-						Blank 2' - 0				
-						Sand 6' - 1'				
-						Bentonite 1' - .5'				
-						Concrete .5' - 0				

TD=6'





# Mobil Oil/ADC Bulk

PROJECT: **Plant Properties**

W.O. 11-04558-09 WELL NO. GP-1

Elevation reference: *Unknown*  
 Ground surface elevation: *Unknown*

Well completed: **19 March 1996**  
 Casing elevation: *Unknown*

## AS-BUILT DESIGN

Page 1  
of 1

DEPTH (feet)	SOIL DESCRIPTION	SAMPLE TYPE	SAMPLE NUMBER	BLOW COUNTS	OVM READING	GROUND WATER
0	Gravel Surfacing over moist, brown, silty, gravelly SAND, non-odorous					
	Weathered, red clay brick					
	Moist, brown, silty, fine SAND with some gravel and minor brick fragments		GP-1/ 3.0'		0.0	
5	Moist to wet, gray, fine to medium SAND, petroleum odor at 7.0 feet		GP-1/ 8.0'		27.0	3/22/96
	Grades to wet, gray, fine to coarse SAND (3-inch fine sandy silt layer at 10.0 feet)		GP-1/ 10.0'		7.0	ATD

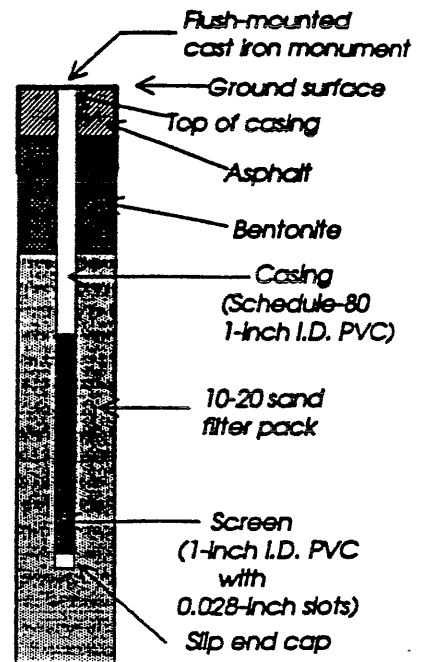

TESTING

WPH-D

Bottom of boring at 12 feet.

15

20

25

30

### LEGEND

I 2-inch O.D. Geoprobe sample

▼ Observed groundwater level  
 0/00/00 0/00/00 = date observed

▼ Observed groundwater level  
 ATD = at time of drilling

WPH-G/ BEX WPH-D Analytical testing

**AGRA**  
**Earth & Environmental**

11335 NE 122nd Way, Suite 100  
 Kirkland, Washington 98034-6918

Drilling started: **19 March 1996**

Drilling completed: **19 March 1996**

Logged by: **CCC**

# Mobil Oil/ADC Bulk

PROJECT: *Plant Properties*

W.O. 11-04558-09 WELL NO. GP-2

Elevation reference: *Unknown*  
 round surface elevation: *Unknown*

Well completed: 19 March 1996  
 Casing elevation: *Unknown*

AS-BUILT DESIGN

Page 1 of 1

DEPTH (feet)	SOIL DESCRIPTION	SAMPLE TYPE	SAMPLE NUMBER	BLOW COUNTS	OVM READING	GROUND WATER	AS-BUILT DESIGN	TESTING
								WTPH-D
0	Asphalt and base course over moist, gray/brown, silty, gravelly SAND							
	Moist, gray, fine to coarse SAND with some silt, non-odorous		GP-2/ 3.5'		0.0			
5	Grades to gray/brown, silty, fine to medium SAND, non-odorous							
	2-inch fine sandy SILT layer at 7.3 feet		GP-2/ 8.0'		11.0	3/22/96 ATD		
10	Grades to saturated, stained black, fine to medium SAND, strong petroleum odor and LPH globules							
	Fine SAND interbedded with fine wood fragments		GP-2/ 11.0'		11.0			
	Bottom of boring at 12 feet.							
15								
20								
25								
30								

LEGEND

I 2-inch O.D. Geoprobe sample

▼ Observed groundwater level  
 0/00/00 0/00/00 = date observed

▼ Observed groundwater level  
 ATD = at time of drilling

WTPH-G/  
 SEZ  
 WTPH-D  
 WTPH-D BY Analytical testing

**AGRA**  
 Earth & Environmental

11335 NE 122nd Way, Suite 100  
 Kirkland, Washington 98034-6918

AGRA Earth and Environmental, Inc.

# Mobil Oil/ADC Bulk

PROJECT: Plant Properties

W.O. 11-04558-09 WELL NO. GP-3

Elevation reference: Unknown  
Ground surface elevation: Unknown

Well completed: Not Applicable  
Casing elevation: Unknown

AS-BUILT DESIGN

Page 1 of 1

DEPTH (feet)	SOIL DESCRIPTION	SAMPLE TYPE	SAMPLE NUMBER	BLOW COUNTS	OVM READING	GROUND WATER	TESTING
0	Asphalt and base course over moist, gray/brown fine SAND, non-odorous						
5	Grades to moist to wet, gray, fine SAND, strong petroleum odor and LPH		GP-3/ 3.0'		11.0	ATD	
6.5	Bottom of boring at 6.5 feet, due to refusal.		GP-3/ 6.5'		17.0		WPH-D
10							
15							
20							
25							
30							



Bentonite adbondonment

WPH-D

**LEGEND**

- 2-inch O.D. Geoprobe sample
- Observed groundwater level
- ATD = at time of drilling
- Analytical testing
- 0/00/00 0/00/00 = date observed

**AGRA**  
Earth & Environmental  
11335 NE 122nd Way, Suite 100  
Kirkland, Washington 98034-6918

AGRA Earth & Environmental, Inc.

# Mobil Oil/ADC Bulk

PROJECT: Plant Properties

W.O. 11-04558-09 WELL NO. GP-4

Elevation reference: Unknown Ground surface elevation: Unknown		Well completed: 19 March 1996 Casing elevation: Unknown		AS-BUILT DESIGN			Page 1 of 1	
DEPTH (feet)	SOIL DESCRIPTION	SAMPLE TYPE	SAMPLE NUMBER	BLOW COUNTS	OVM READING	GROUND WATER	TESTING	
0	Asphalt over base course over gray/brown, gravelly, silty SAND, non-odorous							TESTING    WPH-D
5	Moist, brown/black/gray, silty, fine to medium SAND with some gravel, wood and brick fragments, non-odorous Moist to wet, gray/brown, fine SAND, moderate petroleum odor Wood debris and LPH		GP-4/ 4.0		0.0	3/22/96		
			GP-4/ 6.0		7.0	ATD		
			GP-4/ 8.0		11.0			
10	Fine grained wood fragments, slight petroleum staining and odor							
Bottom of boring at 12 feet.								
15								
20								
25								
30								

### LEGEND

I 2-inch O.D. Geoprobe sample

▼ Observed groundwater level  
0/00/00 0/00/00 = date observed

▼ Observed groundwater level  
ATD ATD = at time of drilling

WPH-D  
SEX  
WPH-D  
WPH-D Est. Analytical testing

**AGRA**  
**Earth & Environmental**

11335 NE 122nd Way, Suite 100  
Kirkland, Washington 98034-6918

Elevation reference: Unknown Well completed: 19 March 1996  
 Ground surface elevation: Unknown Casing elevation: Unknown

AS-BUILT DESIGN

DEPTH (feet)	SOIL DESCRIPTION	SAMPLE TYPE	SAMPLE NUMBER	BLOW COUNTS	OVIM READING	GROUND WATER	TESTING
0	Asphalt and base course over moist, gray/black, fine SAND and broken gravel						
	Moist to wet, brown, fine SAND with some silt, trace petroleum odor		GP-5/ 3.0'			ATD	
	Moist to wet, gray, fine SAND, strong petroleum odor, LPH below 3.7 feet		GP-5/ 4.0'			3/22/96	WPH-D
5	Grades to moist, fine sandy SILT		GP-5/ 6.5'				
	Fine grained wood debris with LPH						
	Saturated, gray, fine SAND with LPH		GP-5/ 8.0'				WPH-D
10	Bottom of boring at 9.5 feet, due to refusal.						
15							
20							
25							
30							

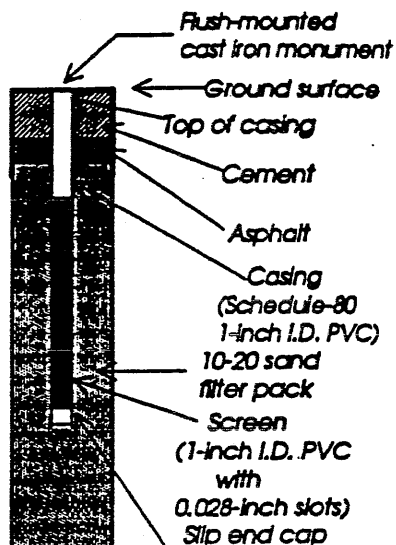

LEGEND

I 2-inch O.D. Geoprobe sample

▼ Observed groundwater level  
 0/00/00 0/00/00 = date observed

▼ Observed groundwater level  
 ATD = at time of drilling

WPH-D  
 BEX  
 WPH-D Est. Analytical testing

**AGRA**  
 Earth & Environmental  
 11335 NE 122nd Way, Suite 100  
 Kirkland, Washington 98034-6918

# Mobil Oil/ADC Bulk

PROJECT: *Plant Properties*

W.O. 11-04558-09 WELL NO. GP-6

Elevation reference: <i>Unknown</i> Ground surface elevation: <i>Unknown</i>		Well completed: 19 March 1996 Casing elevation: <i>Unknown</i>		AS-BUILT DESIGN			Page 1 of 1
DEPTH (feet)	SOIL DESCRIPTION	SAMPLE TYPE	SAMPLE NUMBER	BLOW COUNTS	OVM READING	GROUND WATER	TESTING
0	Asphalt and base course over moist, gray, fine SAND with silt rich zones (2 to 3 feet - silty, gravelly SAND with wood debris, non-odorous)						
5	Black, fine to medium sandy SILT and wood fragments, saturated with very viscous LPH		GP-6/ 3.5		15	ATD 3/22/96	
	Fine to medium grained wood debris, petroleum odor, no LPH		GP-6/ 6.0				
10	Wood fragments saturated with very viscous LPH						
Bottom of boring at 12 feet.							
15							
20							
25							
30							

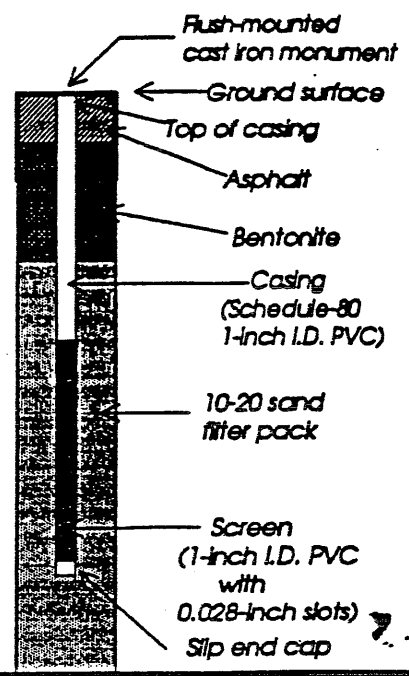

**LEGEND**

- 2-inch O.D. Geoprobe sample
- Observed groundwater level
- Observed groundwater level ATD = at time of drilling
- Analytical testing
- Observed groundwater level 01/01/00 = date observed

**AGRA**  
**Earth & Environmental**  
 11335 NE 122nd Way, Suite 100  
 Kirkland, Washington 98034-6918

Drilling started: 19 March 1996

Drilling completed: 19 March 1996

Logged by: CCC

AGRA Earth & Environmental, Inc.

# Mobil Oil/ADC Bulk

PROJECT: Plant Properties

W.O. 11-04558-09 WELL NO. GP-7

Elevation reference: Unknown  
Ground surface elevation: Unknown

Well completed: Not Applicable  
Casing elevation: Unknown

AS-BUILT DESIGN

Page 1 of 1

DEPTH (feet)	SOIL DESCRIPTION	SAMPLE TYPE	SAMPLE NUMBER	BLOW COUNTS	OVM READING	GROUND WATER	TESTING
0	Asphalt and base course over moist, brown, fine SAND with some silt (5-inch sandy SILT layer at 3.0 feet), non-odorous						
			GP-7/4.0			▼ ATD	
5	Moist, brown, silty, gravelly SAND with wood debris and very viscous LPH grading to fine grained wood debris		GP-7/5.5				
	Bottom of boring at 7.0 feet, due to refusal.						
10							
15							
20							
25							
30							



Bentonite abandonment

WTPH-G/  
BTEX  
WTPH-D Ed.

**LEGEND**

┆ 2-inch O.D.  
Geoprobe sample

▼ Observed groundwater level  
0/00/00 0/00/00 = date observed

▼  
ATD Observed groundwater level  
ATD = at time of drilling

WTPH-G/  
BTEX  
WTPH-D Ed.  
Analytical testing

**AGRA**  
**Earth & Environmental**

11335 NE 122nd Way, Suite 100  
Kirkland, Washington 98034-6918

Drilling started: 20 March 1996

Drilling completed: 20 March 1996

Logged by: CCC

AGRA Earth and Environmental, Inc.

# Mobil Oil/ADC Bulk

PROJECT: **Plant Properties**

W.O. 11-04558-09 WELL NO. GP-8

Elevation reference: *Unknown* Well completed: 20 March 1996  
 Ground surface elevation: *Unknown* Casing elevation: *Unknown*

## AS-BUILT DESIGN

Page 1 of 1

DEPTH (feet)	SOIL DESCRIPTION	SAMPLE TYPE	SAMPLE NUMBER	BLOW COUNTS	QVM READING	GROUND WATER	TESTING
0	Asphalt and base course						
	Minor recovery, moist, dark gray SAND, slight petroleum odor		GP-8/ 3.0'			▼ 3/22/96	
5	Moist, black to gray/green, fine sandy SILT with wood debris, 1" thick zone of LPH						
	Fine grained wood debris saturated with LPH over gray/green SILT		GP-8/ 9.0'		11		
10	Minor recovery - silty, fine SAND over fine grained wood debris, petroleum odor						
	Bottom of boring at 11 feet.						
15							
20							
25							
30							

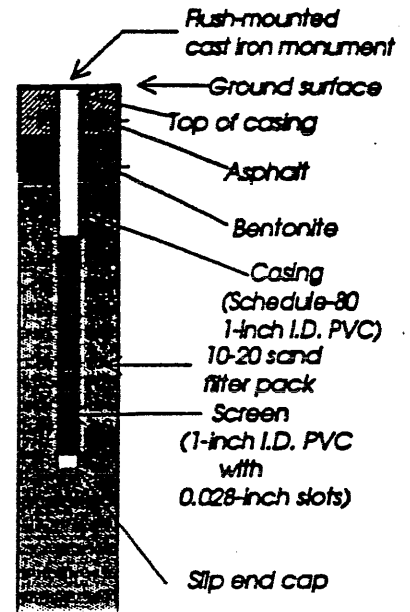

WTPH-G/  
WTPH-D Dr.

### LEGEND

- 1-inch O.D. Geoprobe sample
- Observed groundwater level
- Observed groundwater level
- Analytical testing
- ATD = at time of drilling
- 0/00/00 = date observed

**AGRA**  
**Earth & Environmental**  
 11335 NE 122nd Way, Suite 100  
 Kirkland, Washington 98034-6918

Drilling started: 20 March 1996

Drilling completed: 20 March 1996

Logged by: CCC

AGRA Earth and Environmental, Inc.



Elevation reference: Unknown  
Ground surface elevation: Unknown

Well completed: 20 March 1996  
Casing elevation: Unknown

AS-BUILT DESIGN

DEPTH (feet)	SOIL DESCRIPTION	SAMPLE TYPE	SAMPLE NUMBER	BLOW COUNTS	OVM READING	GROUND WATER
0	Asphalt and base course					
-	Trace recovery; minor gravel and wood fragments					
5	Minor recovery; moist, gray, fine SAND over minor wood debris and sandy SILT with gravel, strong petroleum odor					3/22/96
10	No recovery		GP-9/ 8.0		3.0	
12	Bottom of boring at 12 feet.					
15						
20						
25						
30						

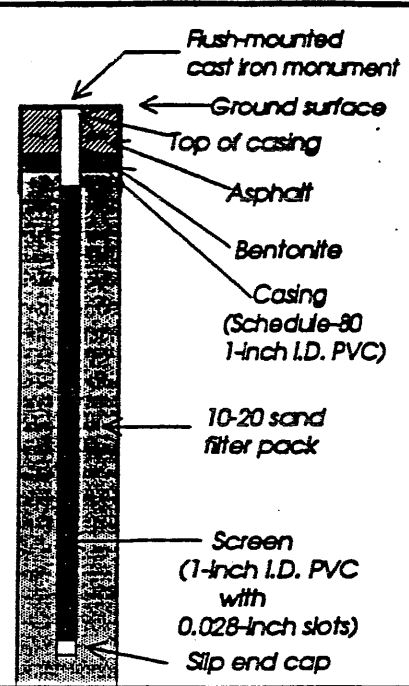

TESTING

WTPH-G/  
BTEX  
WTPH-D B2  
WTPH-D

LEGEND

- 2-inch O.D. Geoprobe sample
- Observed groundwater level  
0/00/00 = date observed
- Observed groundwater level  
ATD = at time of drilling
- Analytical testing

**AGRA**  
Earth & Environmental  
11335 NE 122nd Way, Suite 100  
Kirkland, Washington 98034-6918

AGRA Earth & Environmental, Inc.

# Mobil Oil/ADC Bulk

PROJECT: **Plant Properties**

W.O. 11-04558-09 WELL NO. GP-10

Elevation reference: *Unknown*  
Ground surface elevation: *Unknown*

Well completed: 20 March 1996  
Casing elevation: *Unknown*

## AS-BUILT DESIGN

Page 1 of 1

DEPTH (feet)	SOIL DESCRIPTION	SAMPLE TYPE	SAMPLE NUMBER	BLOW COUNTS	OVM READING	GROUND WATER	TESTING
0	Asphalt and base course over moist, brown/gray, silty, fine SAND, non-odorous		GP-10/ 3.0'		1.0		
5	Moist, gray, fine sandy SILT with some gravel, slight petroleum odor Woody debris saturated with LPH Moist to wet, gray/orange/brown, gravelly, medium to coarse SAND, petroleum odor		GP-10/ 7.0'			3/22/96	
	Wet, brown stained gray, fine sandy SILT, strong petroleum odor, minor LPH Wet, brown, fine grained wood debris with LPH, minor saturated sand						
10	Saturated, gray, fine SAND with wood debris, strong sulfur odor, slight petroleum odor Wood fragments		GP-10/ 11.0'		0.0		
	Bottom of boring at 12 feet.						
15							
20							
25							
30							

### LEGEND

I 2-inch O.D. Geoprobe sample

▼ Observed groundwater level  
0/00/00 0/00/00 = date observed

▼ ATD Observed groundwater level  
ATD = at time of drilling

WPH-G/  
SEX  
WPH-O  
WPH-O-EX Analytical testing

**AGRA**  
Earth & Environmental  
11335 NE 122nd Way, Suite 100  
Kirkland, Washington 98034-6918

Drilling started: 20 March 1996

Drilling completed: 20 March 1996

Logged by: CCC

# Mobil Oil/ADC Bulk

PROJECT: Plant Properties

W.O. 11-04558-09 WELL NO. GP-11

Elevation reference: Unknown  
Ground surface elevation: Unknown

Well completed: 20 March 1996  
Casing elevation: Unknown

## AS-BUILT DESIGN

Page 1 of 1

DEPTH (feet)	SOIL DESCRIPTION	SAMPLE TYPE	SAMPLE NUMBER	BLOW COUNTS	QVM READING	GROUND WATER	TESTING
0	Asphalt and base course over moist, brown, silty, fine SAND, non-odorous		GP-11/ 3.0'		4.0		
5	Moist, gray, silty, fine SAND with mottling and some shells and wood debris Moist, tan grading to gray, fine sandy SILT with interbedded wood debris, slight petroleum odor at 4.0 feet		GP-11/ 6.5'			<div style="border: 1px solid black; padding: 2px; width: fit-content;">                     WTPH-D WTPH-G/ WTEX WTPH-D WTPH-D Ed.                 </div>	
	Wet to saturated, brown, silty, gravelly SAND, strong petroleum odor, minor LPH		GP-11/ 8.0'		0.0		
10	Saturated, black, fine SAND, trace petroleum odor		GP-11/ 12.0'				
Bottom of boring at 12 feet.							
15							
20							
25							
30							

### LEGEND

┆ 2-inch O.D. Geoprobe sample

▼ Observed groundwater level  
0.00/00 0/00/00 = date observed

▼ Observed groundwater level  
ATD = at time of drilling

WTPH-G/  
WTEX  
WTPH-D  
WTPH-D Ed. Analytical testing

**AGRA**  
Earth & Environmental

11335 NE 122nd Way, Suite 100  
Kirkland, Washington 98034-6918

Drilling started: 20 March 1996

Drilling completed: 20 March 1996

Logged by: CCC

# Mobil Oil/ADC Bulk

PROJECT: Plant Properties

W.O. 11-04558-09 WELL NO. GP-12

Elevation reference: Unknown  
Ground surface elevation: Unknown

Well completed: 20 March 1996  
Casing elevation: Unknown

## AS-BUILT DESIGN

Page 1 of 1

DEPTH (feet)	SOIL DESCRIPTION	SAMPLE TYPE	SAMPLE NUMBER	BLOW COUNTS	QVM READING	GROUND WATER	TESTING
0	Asphalt and base course over moist, black, gravelly SAND, slight petroleum odor						
5	Moist, gray/brown, fine to coarse SAND grading to brown, fine SAND with some gravel, non-odorous		GP-12/ 8.0'				
10	Wet, gray stained globules black, fine SAND with gravel, strong petroleum odor and minor LPH globules		GP-12/ 10.0'			3/22/96 ATD	
	Saturated, gray, fine SAND with some gravel, strong petroleum odor, minor globules of LPH		GP-12/ 11.0'				WITH-D
			GP-12/ 12.5'		3.2		WITH-D
15	Bottom of boring at 14 feet.						
20							
25							
30							

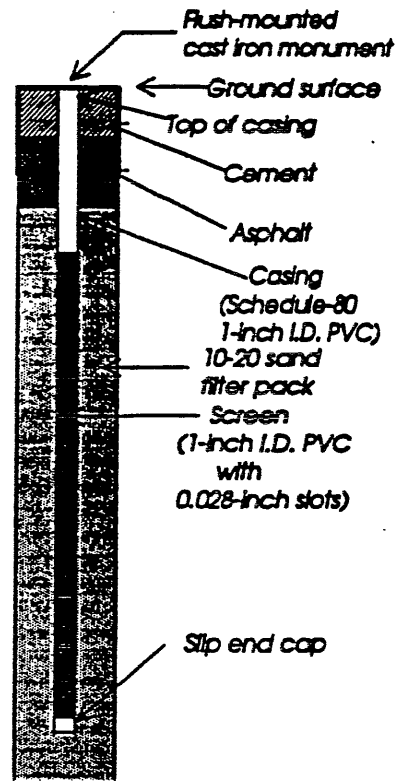

### LEGEND

I 2-inch O.D. Geoprobe sample

▼ Observed groundwater level  
0/00/00 0/00/00 = date observed

▼ Observed groundwater level  
ATD = at time of drilling

WITH-D/SDX/SDX/SDX/SDX Analytical testing

**AGRA**  
Earth & Environmental

11335 NE 122nd Way, Suite 100  
Kirkland, Washington 98034-6918

Drilling started: 19 March 1996

Drilling completed: 19 March 1996

Logged by: CCC

# Mobil Oil/ADC Bulk

PROJECT: Plant Properties

W.O. 11-04558-09 WELL NO. GP-13

Elevation reference: Unknown  
Ground surface elevation: Unknown

Well completed: 20 March 1996  
Casing elevation: Unknown

AS-BUILT DESIGN

Page 1  
of 1

DEPTH (feet)	SOIL DESCRIPTION	SAMPLE TYPE	SAMPLE NUMBER	BLOW COUNTS	OVM READING	GROUND WATER	TESTING
0	Asphalt over dense, moist, gray, gravelly, fine to coarse SAND, non-odorous		GP-13/ 3.5'				
5	Grades to moist, gray/black, gravelly, fine to medium SAND, non-odorous		GP-13/ 7.0'				WPH-D
10	Wet/saturated, gray/black, silty, fine SAND with some gravel and some wood debris, organic odor		GP-13/ 10.0'			ATD	WPH-G/ WPH-D WPH-D Ext. WPH-D
Bottom of boring at 12 feet.							
15							
20							
25							
30							



Bentonite abandonment

AGRA Earth & Environmental, Inc.

**LEGEND**

I 2-inch O.D.  
Geoprobe sample

▼ Observed groundwater level  
0/00/00 0/00/00 = date observed

▼ Observed groundwater level  
ATD ATD = at time of drilling

WPH-G/  
WPH-D  
WPH-D Ext.  
Analytical testing

**AGRA**  
Earth & Environmental

11335 NE 122nd Way, Suite 100  
Kirkland, Washington 98034-6918

Drilling started: 20 March 1996

Drilling completed: 20 March 1996

Logged by: CCC



**SOIL DESCRIPTION**

Ground Surface Elevation Approximately                      Feet

Loose, wet to saturated, brown-gray, silty fine SAND and fine sandy SILT with a trace of gravel (Fill)

Very loose to loose, saturated, gray, silty fine to medium SAND with a trace of gravel (Fill)

Soft, saturated, brown, silty PEAT

Total depth 11½ feet  
Boring completed 9 March 1988

DEPTH (FEET)

LAB TESTS

SAMPLING

GROUND WATER

**STANDARD PENETRATION RESISTANCE**

▲ BLOWS PER FOOT  
(140 lb. hammer, 30 inch drop)

0 10 20 30 40 50

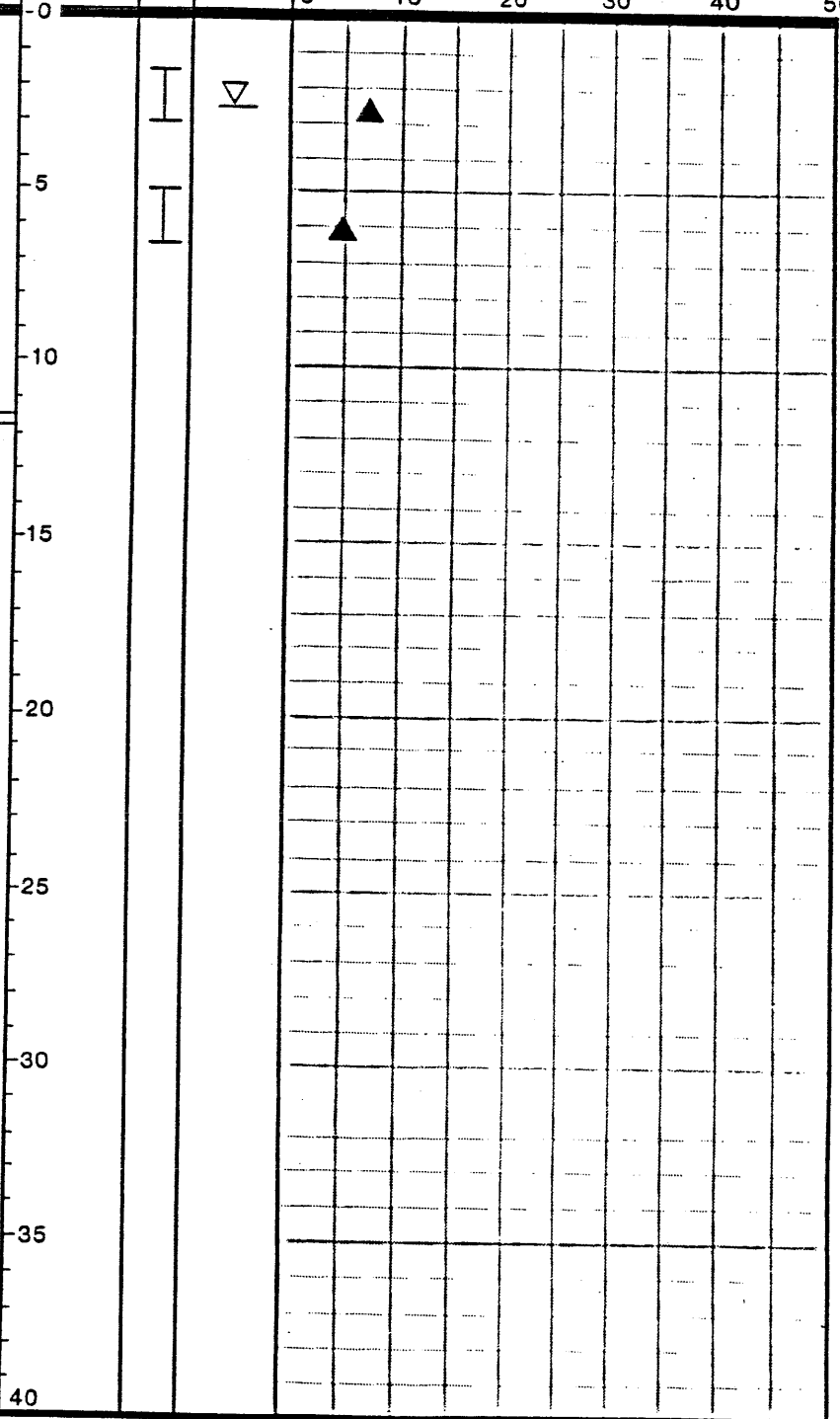

**SAMPLING**

- I 2' OD SPLIT SPOON SAMPLE
- II 3' OD SHELBY SAMPLE
- 1.5' ID RING SAMPLE
- BULK SAMPLE
- \* SAMPLE NOT RECOVERED

GROUND WATER  SEAL

DATE

WATER LEVEL AT TIME OF DRILLING



OBSERVATION WELL TIP

**LABORATORY TESTS**

- % WATER CONTENT
- NP NON PLASTIC

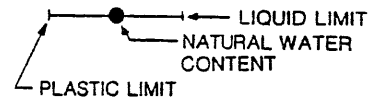

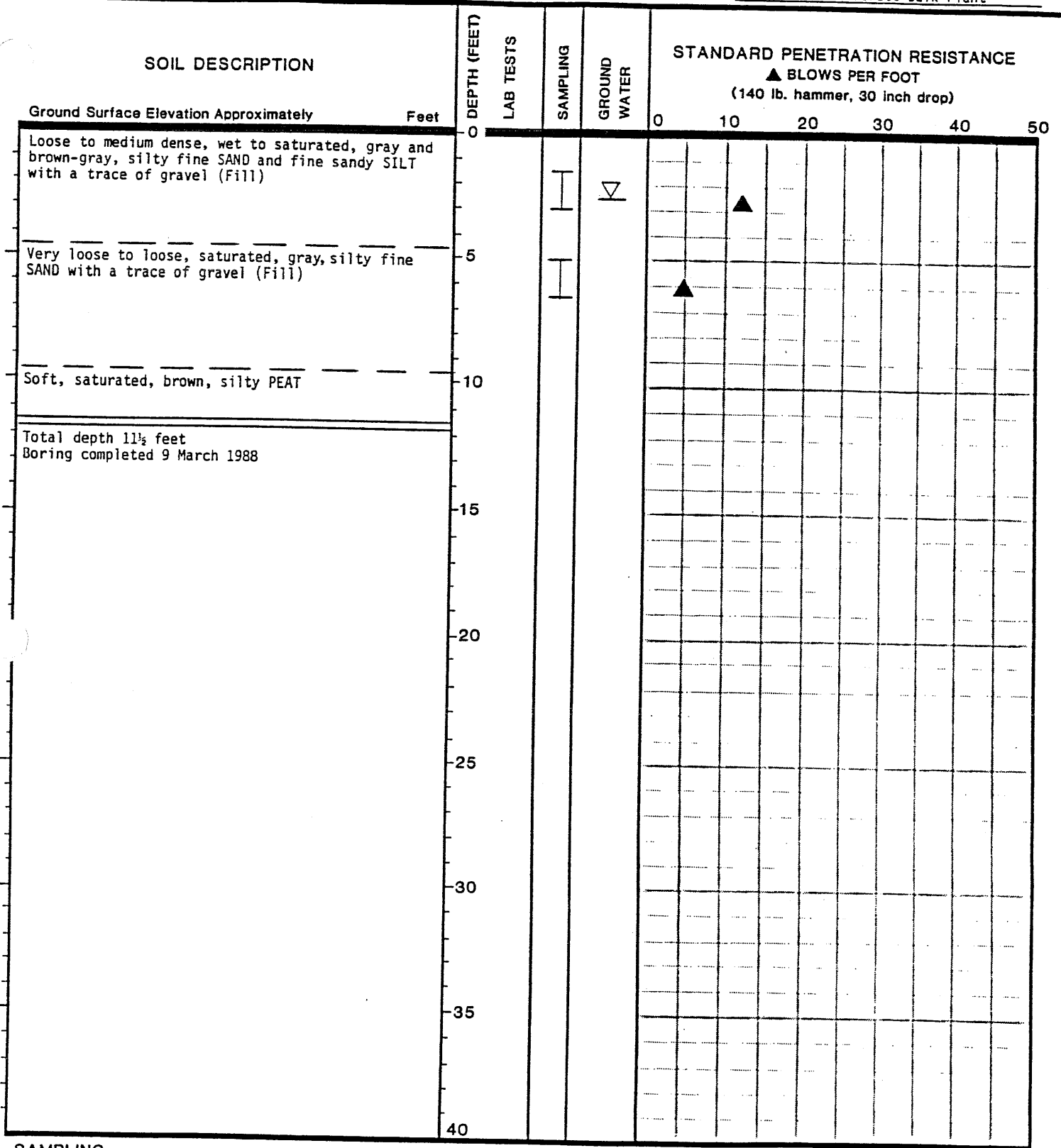

- SAMPLING**
- I 2" OD SPLIT SPOON SAMPLE
  - II 3" OD SHELBY SAMPLE
  - 2.5" ID RING SAMPLE
  - BULK SAMPLE
  - \* SAMPLE NOT RECOVERED

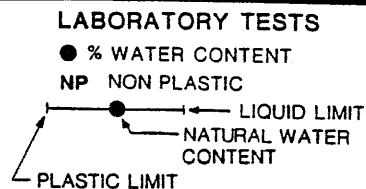
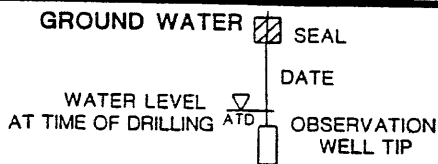



SOIL DESCRIPTION	DEPTH (FEET)	LAB TESTS	SAMPLING	GROUND WATER	STANDARD PENETRATION RESISTANCE					
					▲ BLOWS PER FOOT (140 lb. hammer, 30 inch drop)					
Ground Surface Elevation Approximately Feet	0				0	10	20	30	40	50
Loose, wet to saturated, dark brown, gravelly, silty, fine SAND with a trace to some wood debris (Fill)	0 - 3		I	▽		10				
Very loose, saturated, wood debris	3 - 5									
Very loose to loose, saturated, dark brown-gray and gray, silty, fine SAND (Fill)	5 - 8		II		10					
	8 - 10				10					
Soft, saturated, brown, silty PEAT	10 - 11.5									
Total depth 11½ feet Boring completed 9 March 1988	11.5									
	15									
	20									
	25									
	30									
	35									
	40									

- SAMPLING**  
 I 2" OD SPLIT SPOON SAMPLE  
 II 3" OD SHELBY SAMPLE  
 2.5" ID RING SAMPLE  
 BULK SAMPLE  
 \* SAMPLE NOT RECOVERED

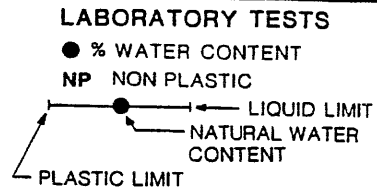
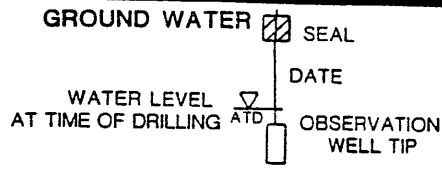



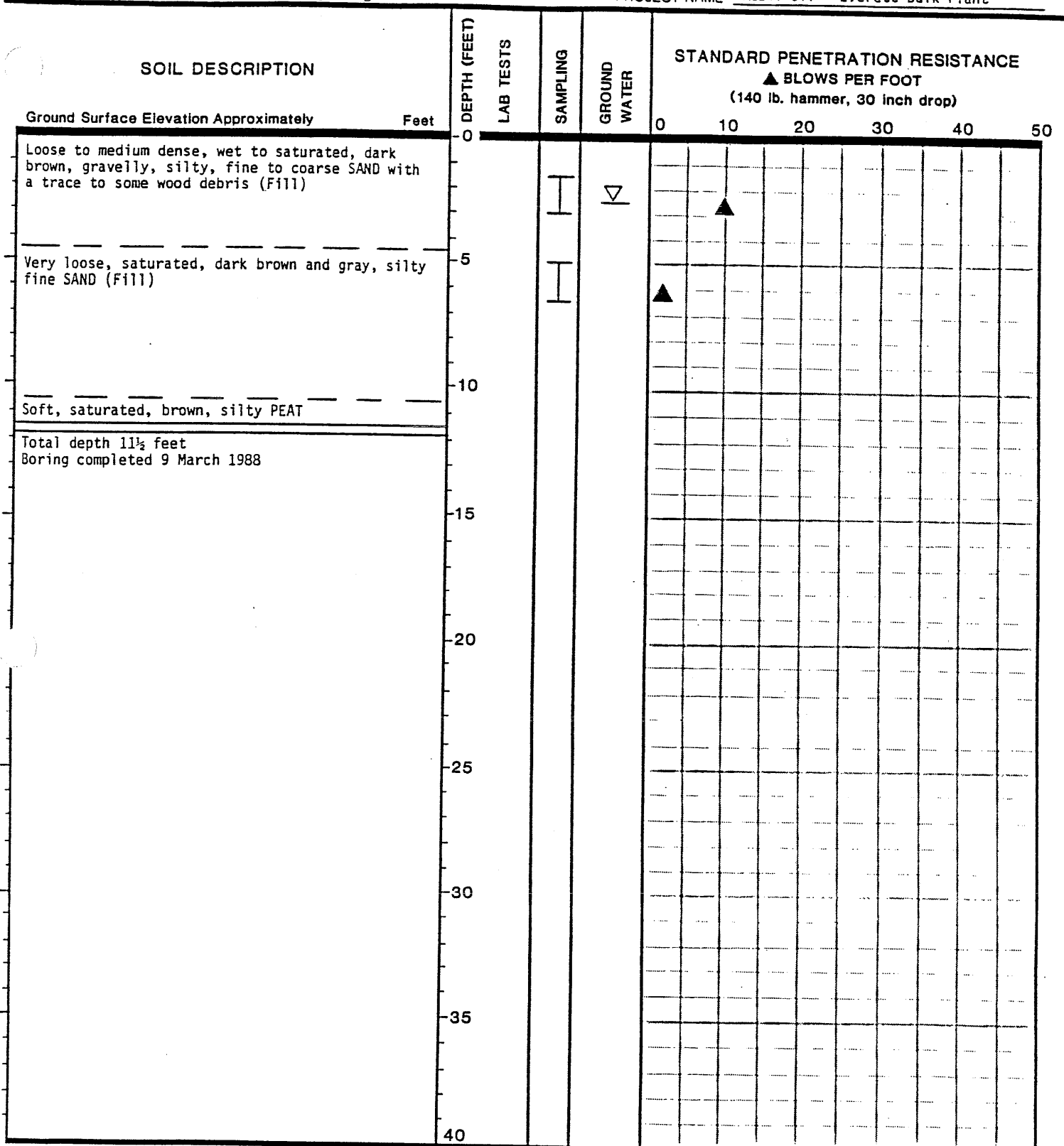

- SAMPLING**  
 I 2' OD SPLIT SPOON SAMPLE  
 II 3' OD SHELBY SAMPLE  
 2.5' ID RING SAMPLE  
 BULK SAMPLE  
 \* SAMPLE NOT RECOVERED

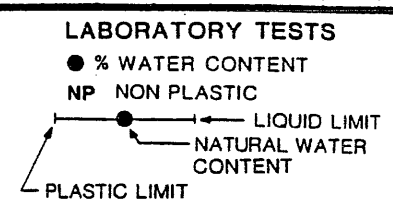
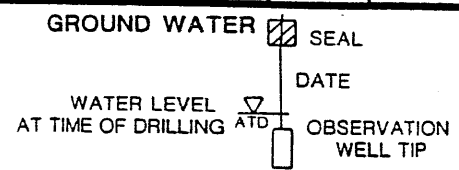



**SOIL DESCRIPTION**

Ground Surface Elevation Approximately Feet

Very loose, wet to saturated, gray and brown-gray, silty, fine SAND with a trace of gravel and wood debris (Fill)

Loose to medium dense, saturated, gray, silty fine SAND with some fine sandy SILT and a trace of gravel (Fill)

Soft, saturated, brown, silty PEAT

Total depth 11½ feet  
 Boring completed 9 March 1988

DEPTH (FEET)

LAB TESTS

SAMPLING

GROUND WATER

**STANDARD PENETRATION RESISTANCE**

▲ BLOWS PER FOOT  
 (140 lb. hammer, 30 inch drop)

0 10 20 30 40 50

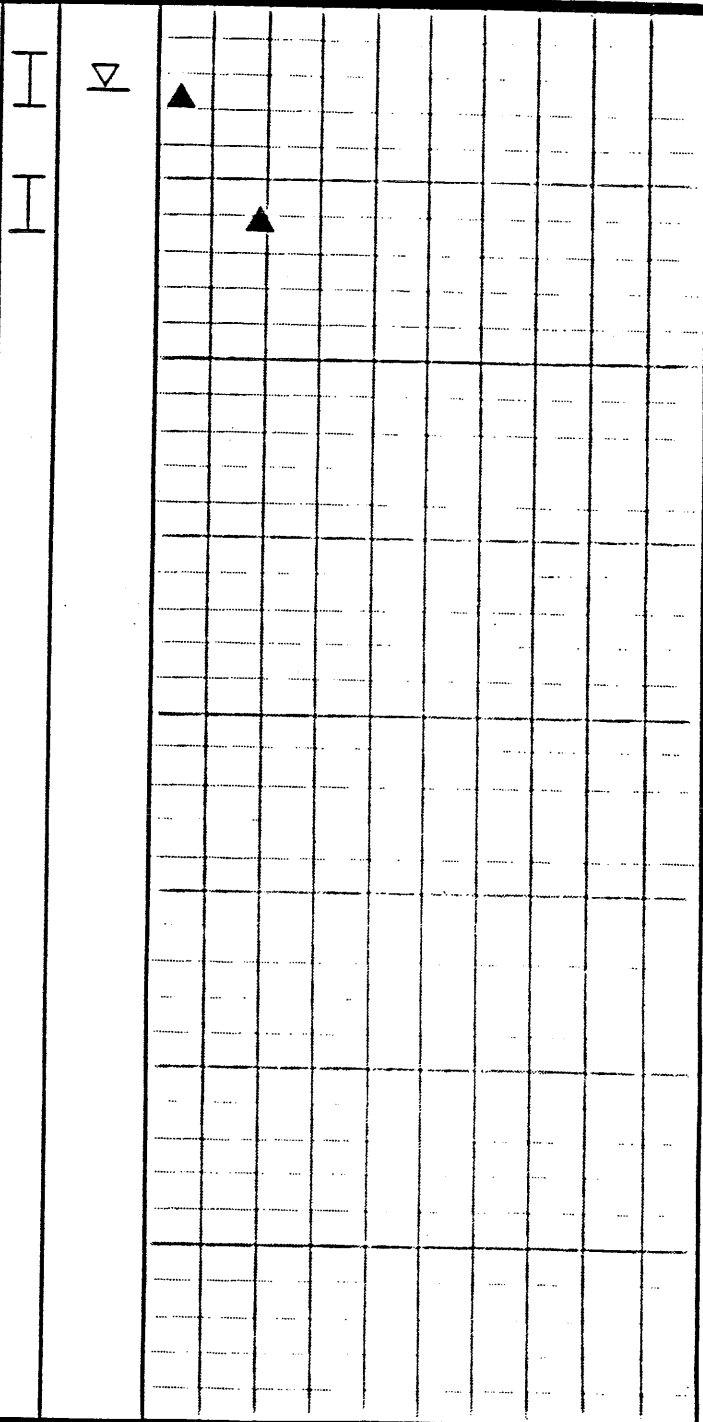

- SAMPLING**
- I 2' OD SPLIT SPOON SAMPLE
  - II 3' OD SHELBY SAMPLE
  - III 5' ID RING SAMPLE
  - LK SAMPLE
  - \* SAMPLE NOT RECOVERED

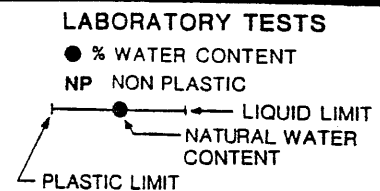
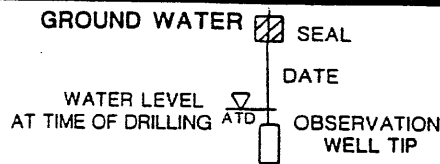

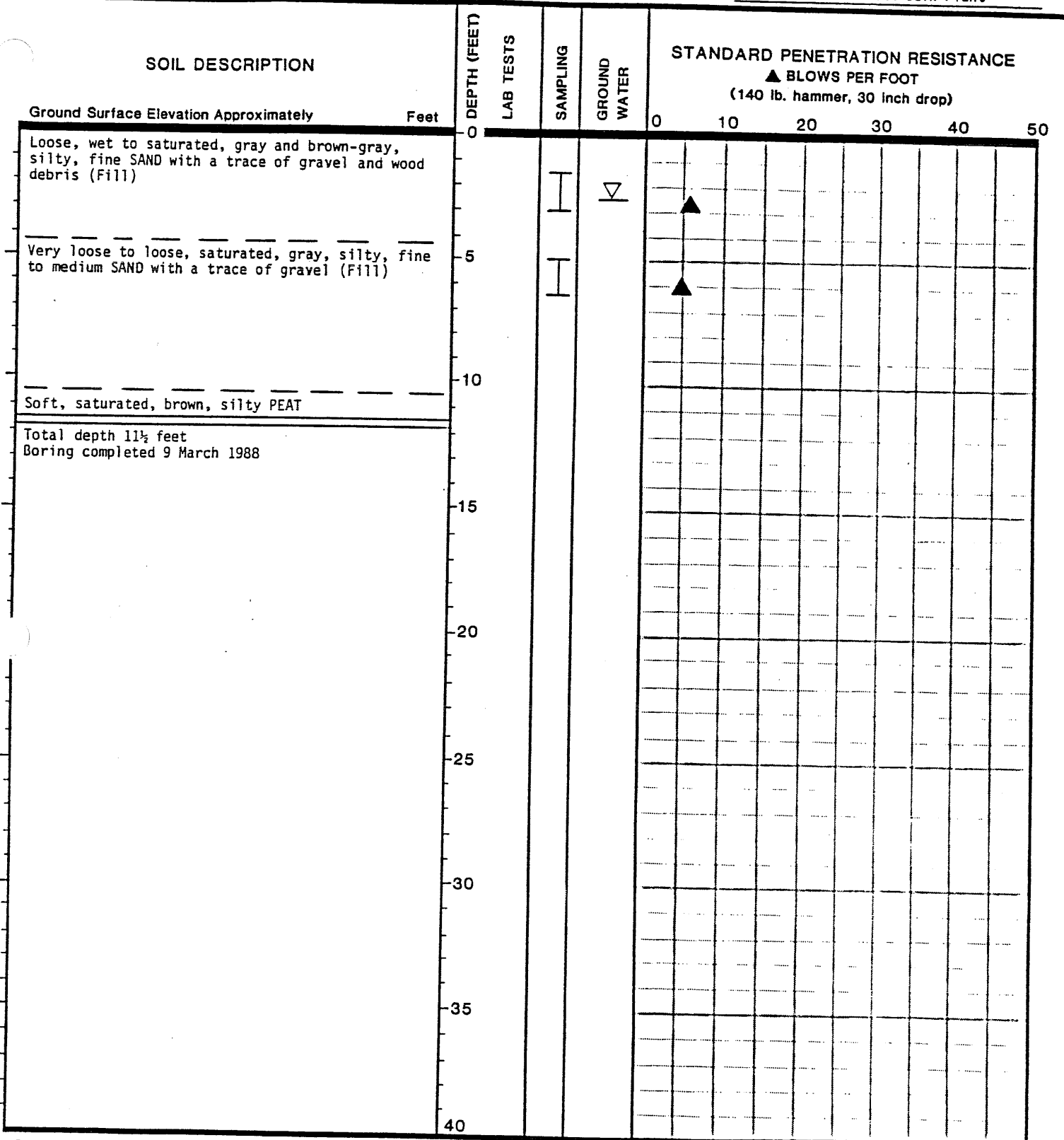

- SAMPLING**
- I 2" OD SPLIT SPOON SAMPLE
  - II 3" OD SHELBY SAMPLE
  - 2.5" ID RING SAMPLE
  - BULK SAMPLE
  - \* SAMPLE NOT RECOVERED

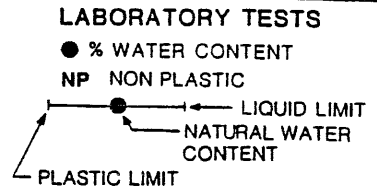
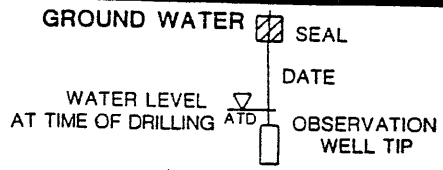

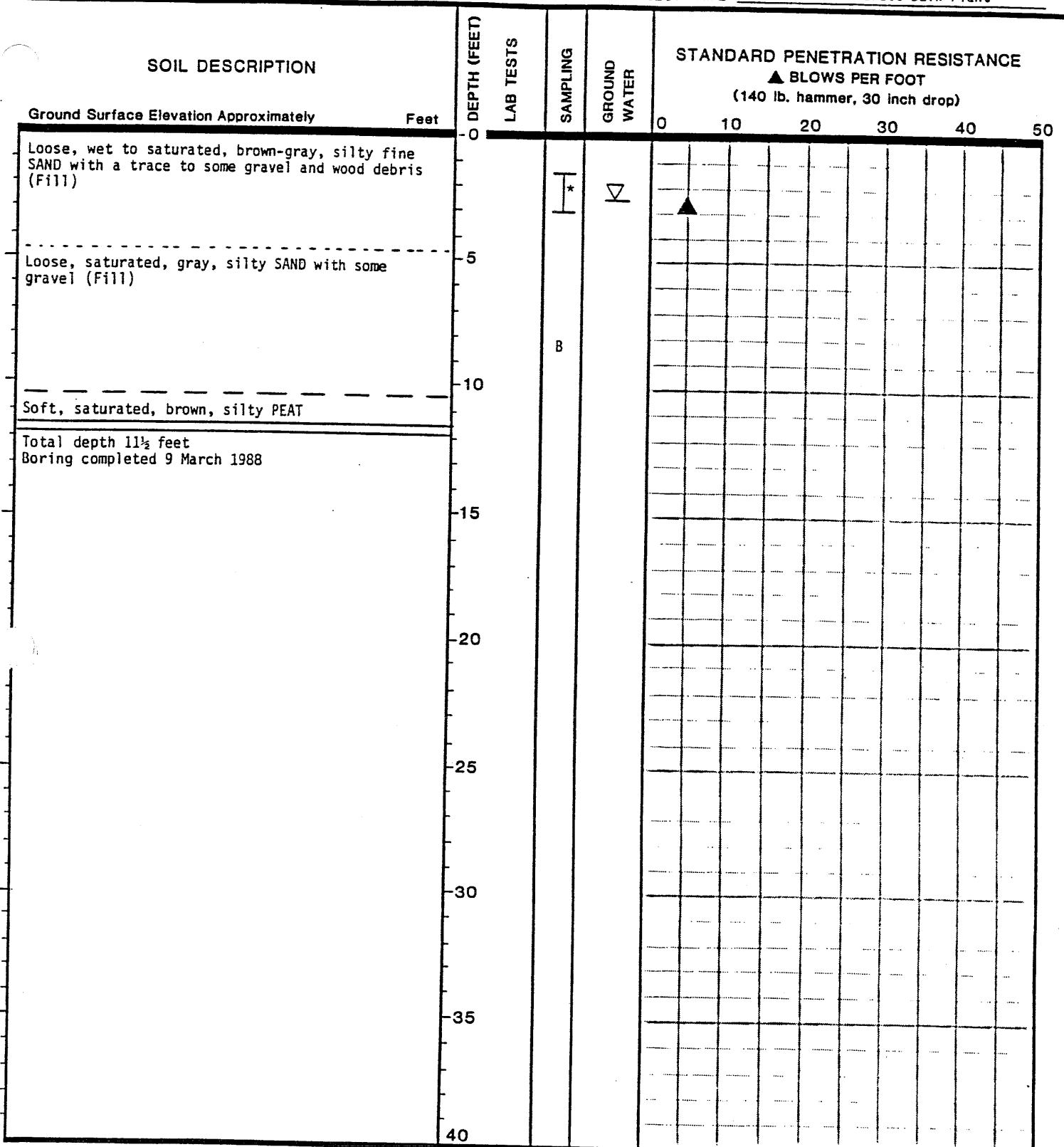

- SAMPLING**
- I 2" OD SPLIT SPOON SAMPLE
  - II 3" OD SHELBY SAMPLE
  - III 2.5" ID RING SAMPLE
  - BULK SAMPLE
  - \* SAMPLE NOT RECOVERED

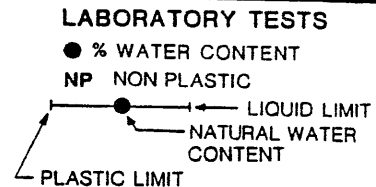
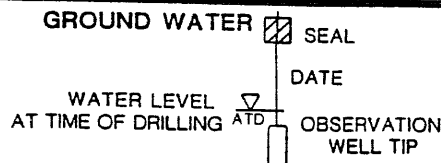



SOIL DESCRIPTION	DEPTH (FEET)	LAB TESTS	SAMPLING	GROUND WATER	STANDARD PENETRATION RESISTANCE ▲ BLOWS PER FOOT (140 lb. hammer, 30 inch drop)										
					0	10	20	30	40	50					
Ground Surface Elevation Approximately _____ Feet	0														
Very loose to medium dense (variable), wet to saturated, dark brown to black, silty fine SAND with some zones of wood, brick, etc. (Fill)	0 - 5		I *	▽	▲	▲									
Loose, saturated, gray, silty SAND with a trace to some gravel (Fill)	5 - 10														
Soft, saturated, brown, silty PEAT	10 - 11.5														
Total depth 11½ feet Boring completed 9 March 1988	11.5														
	15														
	20														
	25														
	30														
	35														
	40														

- SAMPLING**
- I 2" OD SPLIT SPOON SAMPLE
  - II 3" OD SHELBY SAMPLE
  - III 2.5" ID RING SAMPLE
  - BULK SAMPLE
  - \* SAMPLE NOT RECOVERED

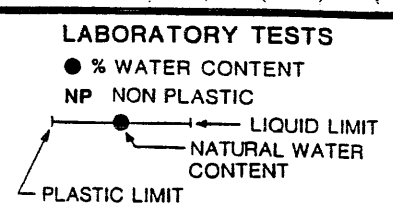
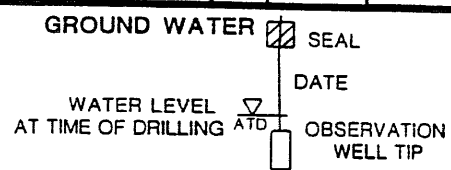



SOIL DESCRIPTION	DEPTH (FEET)	LAB TESTS	SAMPLING	GROUND WATER	STANDARD PENETRATION RESISTANCE					
					▲ BLOWS PER FOOT (140 lb. hammer, 30 inch drop)					
Ground Surface Elevation Approximately <span style="float:right">Feet</span>	0				0	10	20	30	40	50
Very loose to loose, wet to saturated, dark brown and gray, silty fine SAND with a trace of gravel and wood debris (Fill)	0 - 5		I	▽	▲					
Very loose, saturated, gray, silty, fine SAND with a trace of gravel (Fill)	5 - 10		II		▲					
Soft, saturated, brown, silty PEAT	10 - 11.5									
Total depth 11½ feet Boring completed 9 March 1988	11.5									
	15									
	20									
	25									
	30									
	35									
	40									

- SAMPLING**
- I 2' OD SPLIT SPOON SAMPLE
  - II 3' OD SHELBY SAMPLE
  - 2.5' ID RING SAMPLE
  - BULK SAMPLE
  - \* SAMPLE NOT RECOVERED

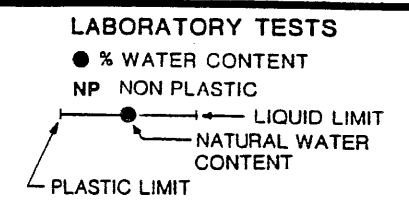
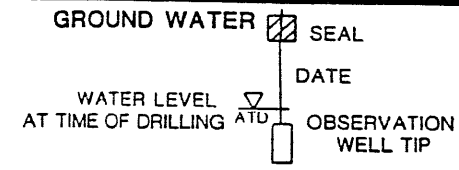

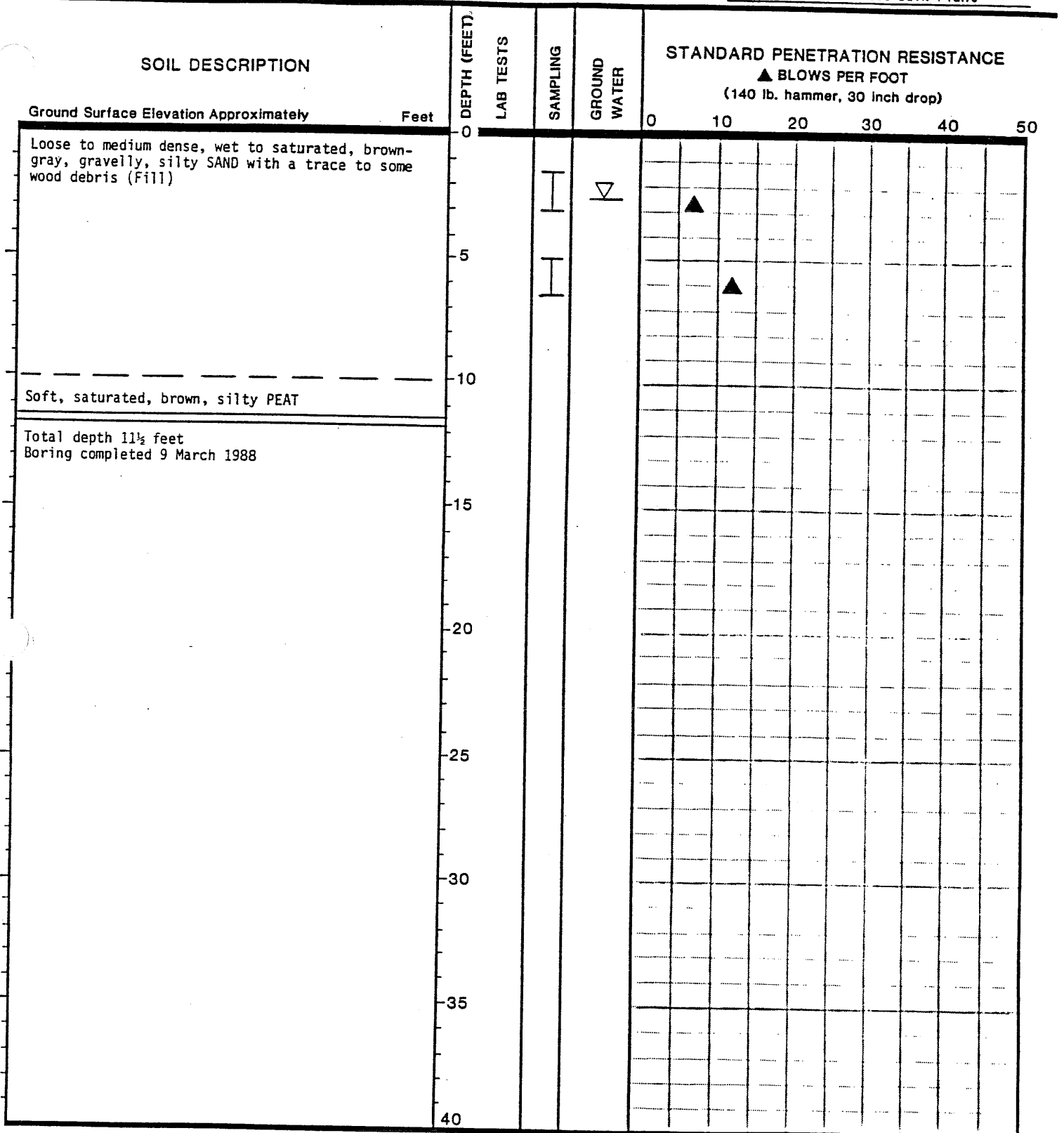

- SAMPLING**
- I 2' OD SPLIT SPOON SAMPLE
  - II 3' OD SHELBY SAMPLE
  - III 2.5' ID RING SAMPLE
  - IV BULK SAMPLE
  - \* SAMPLE NOT RECOVERED

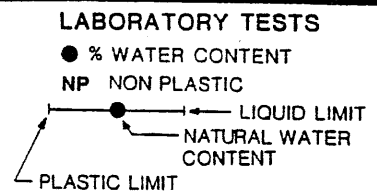
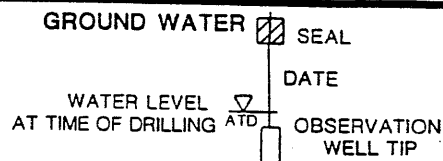



**SOIL DESCRIPTION**

Ground Surface Elevation Approximately Feet

Loose to medium dense, wet to saturated, brown-gray to gray, silty, fine to medium SAND with a trace of gravel (Fill)

Very loose, saturated, gray, silty, fine to medium SAND with trace of gravel, wood debris and black organics (Fill)

Soft, saturated, brown, silty PEAT

Total depth 11½ feet  
Boring completed 10 March 1988

DEPTH (FEET)

LAB TESTS

SAMPLING

GROUND WATER

**STANDARD PENETRATION RESISTANCE**

▲ BLOWS PER FOOT  
(140 lb. hammer, 30 inch drop)

0 10 20 30 40 50

40

- SAMPLING**
- I 2' OD SPLIT SPOON SAMPLE
  - II 3' OD SHELBY SAMPLE
  - III 2.5' ID RING SAMPLE
  - IV JULK SAMPLE
  - \* SAMPLE NOT RECOVERED

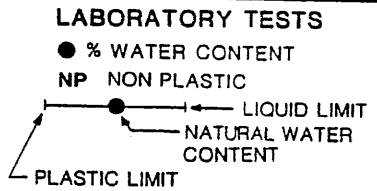
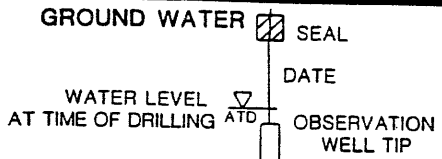



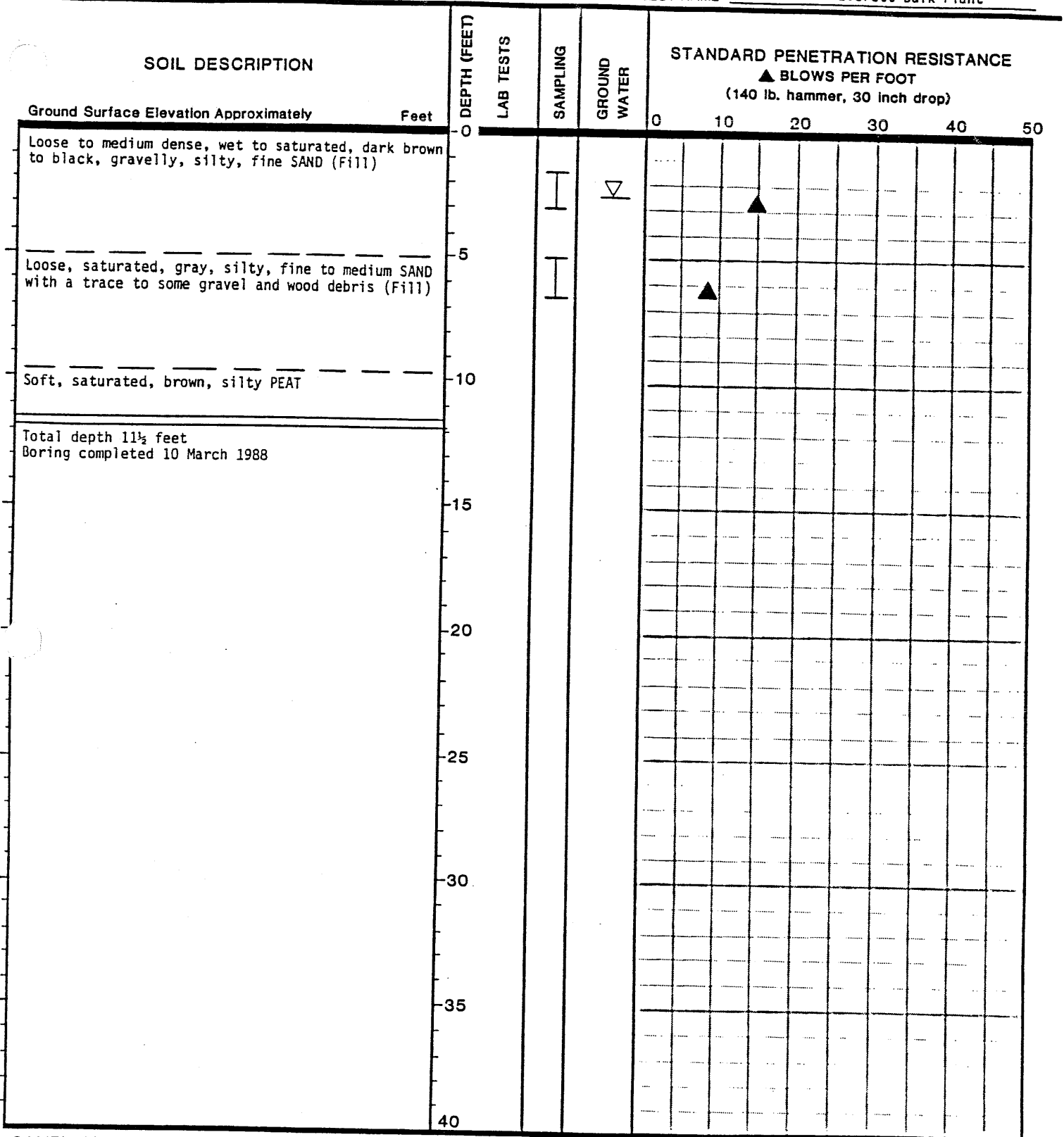

- SAMPLING**
- I 2' OD SPLIT SPOON SAMPLE
  - II 3' OD SHELBY SAMPLE
  - III 2.5' ID RING SAMPLE
  - BULK SAMPLE
  - \* SAMPLE NOT RECOVERED

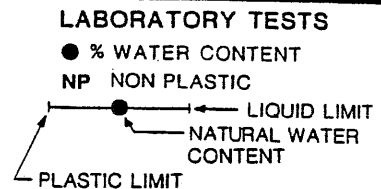
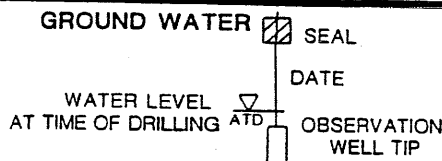

## PORTABLE PERCUSSION BORING LOG MW-19

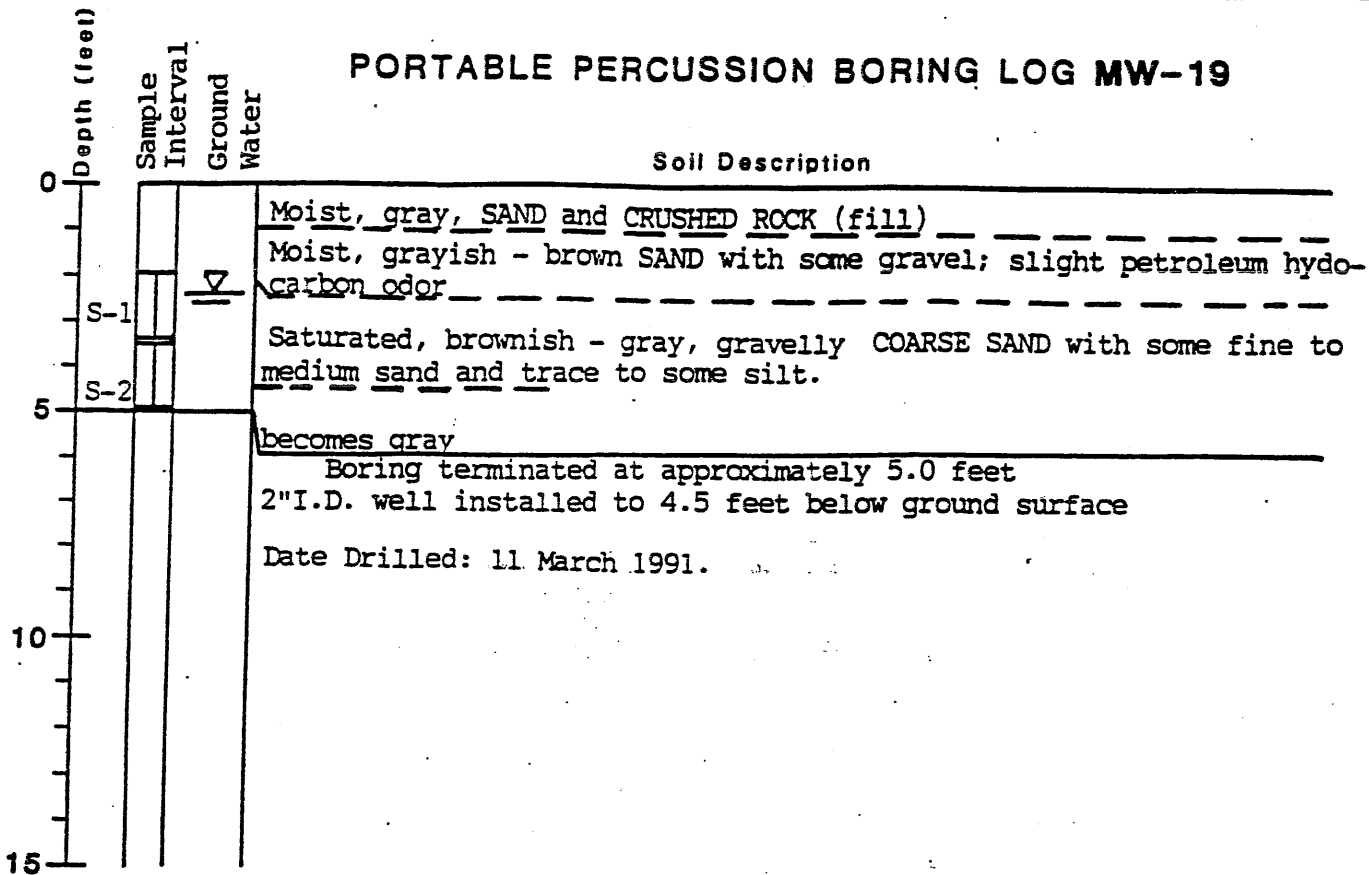

## PORTABLE PERCUSSION BORING LOG MW-20

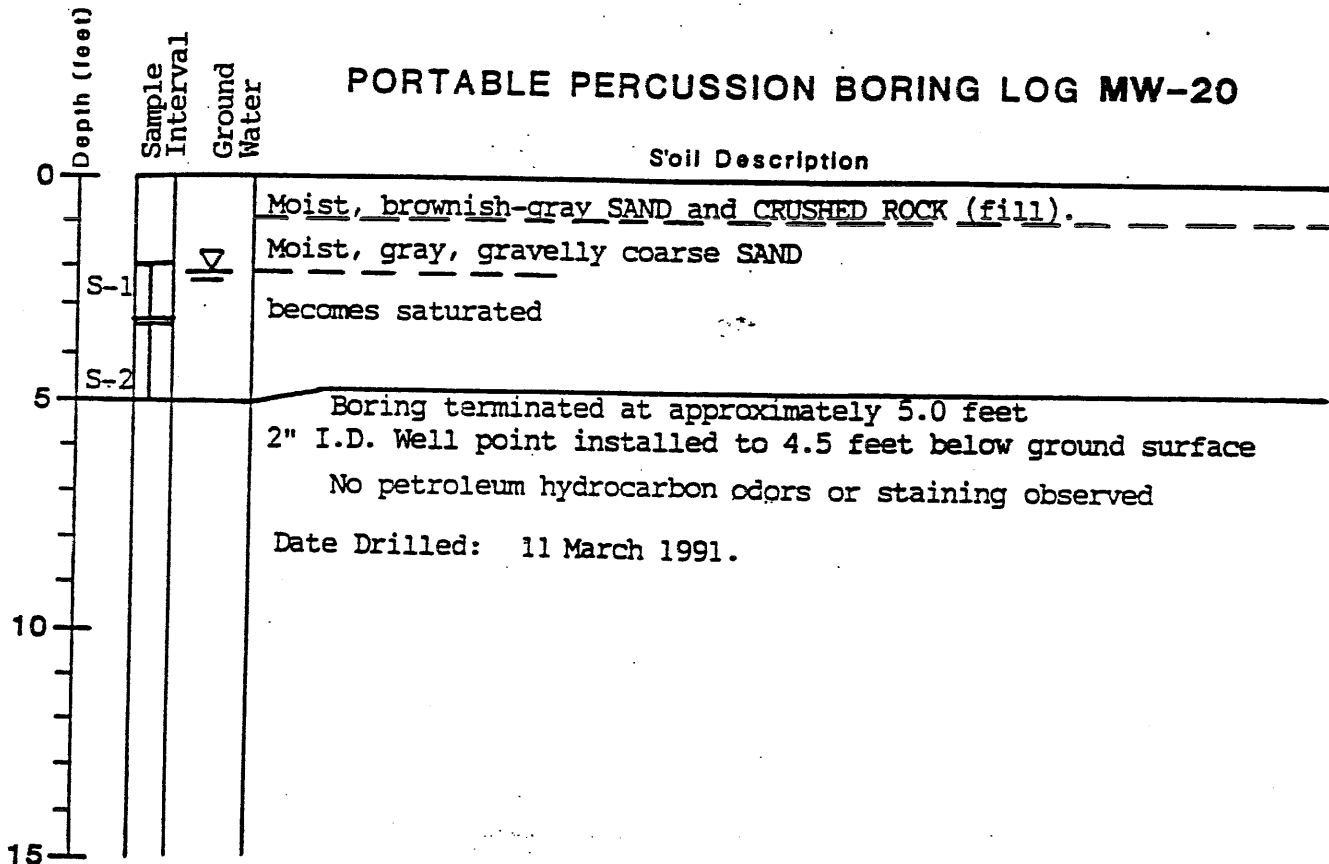

▽ ATD groundwater level at time of drilling

**RITTENHOUSE-ZEMAN & ASSOCIATES, INC.**  
 Geotechnical Consultants  
 1400 140th N.E.  
 Bellevue, Washington 98007  
 (206) 736-8020



## PORTABLE PERCUSSION BORING LOG MW-21

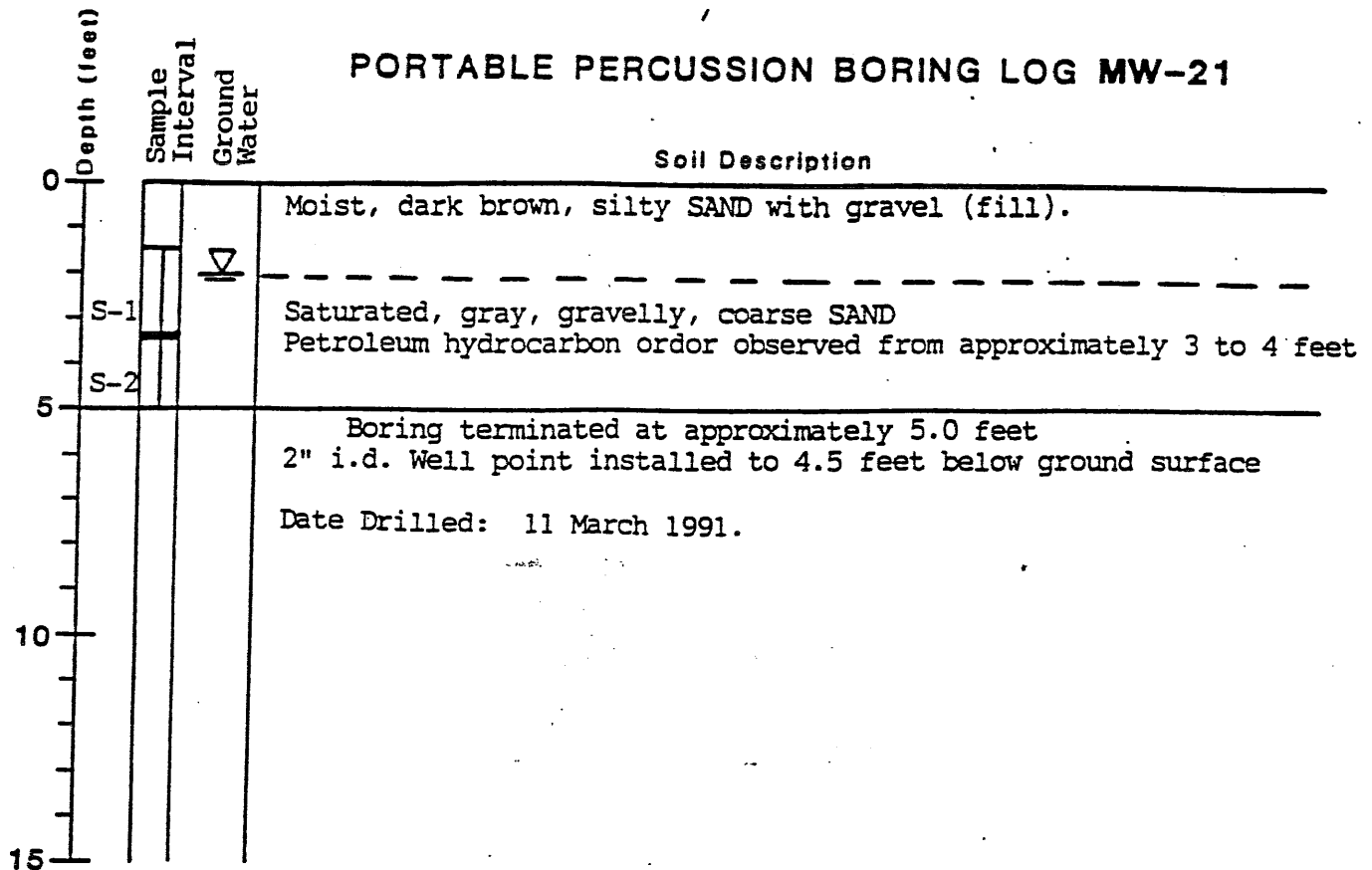

## PORTABLE PERCUSSION BORING LOG MW-22

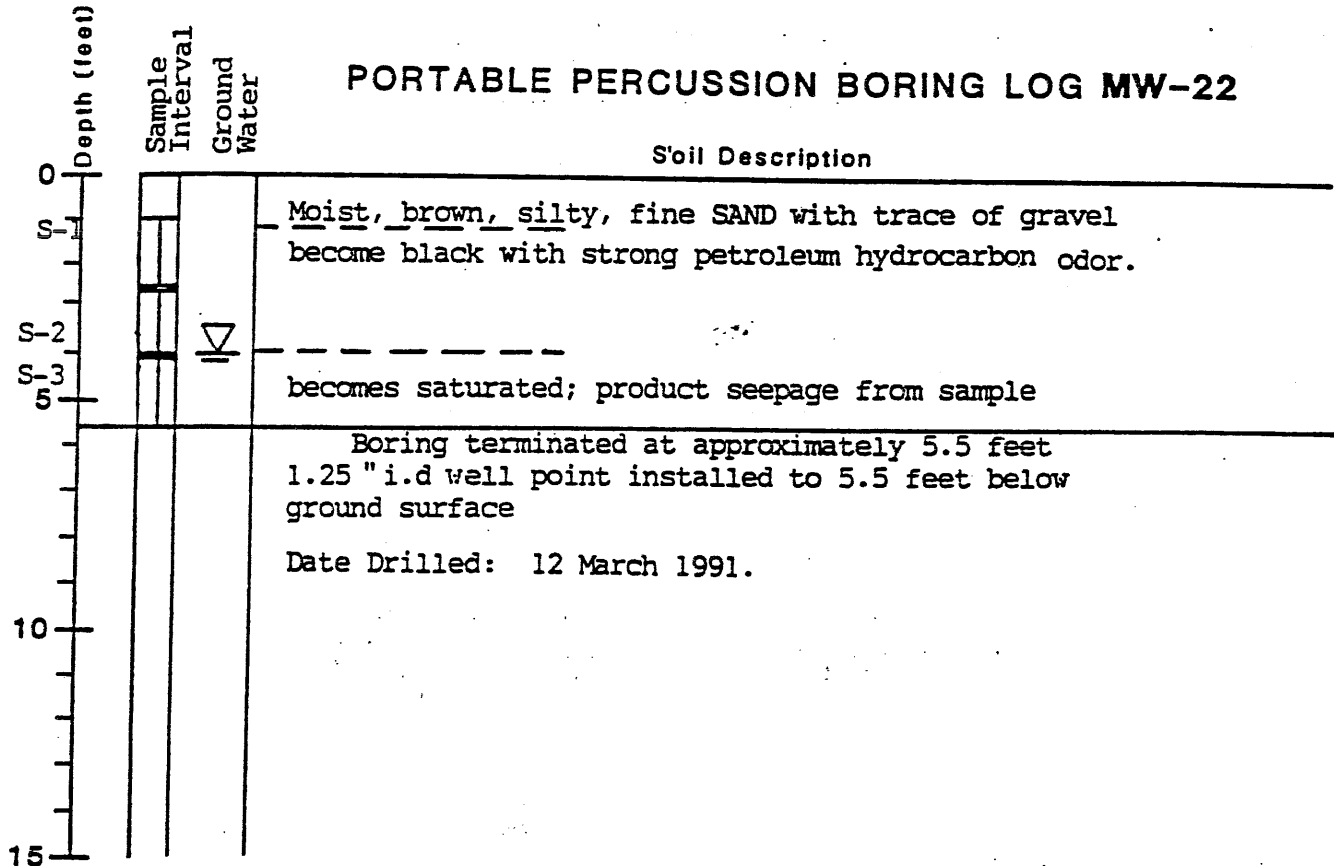

groundwater at time of drilling

**RITTENHOUSE-ZEMAN & ASSOCIATES, INC.**

*Geotechnical Consultants*

1400 140th N.E.  
Bellevue, Washington 98007  
(206) 736-8020



## PORTABLE PERCUSSION BORING LOG MW-23

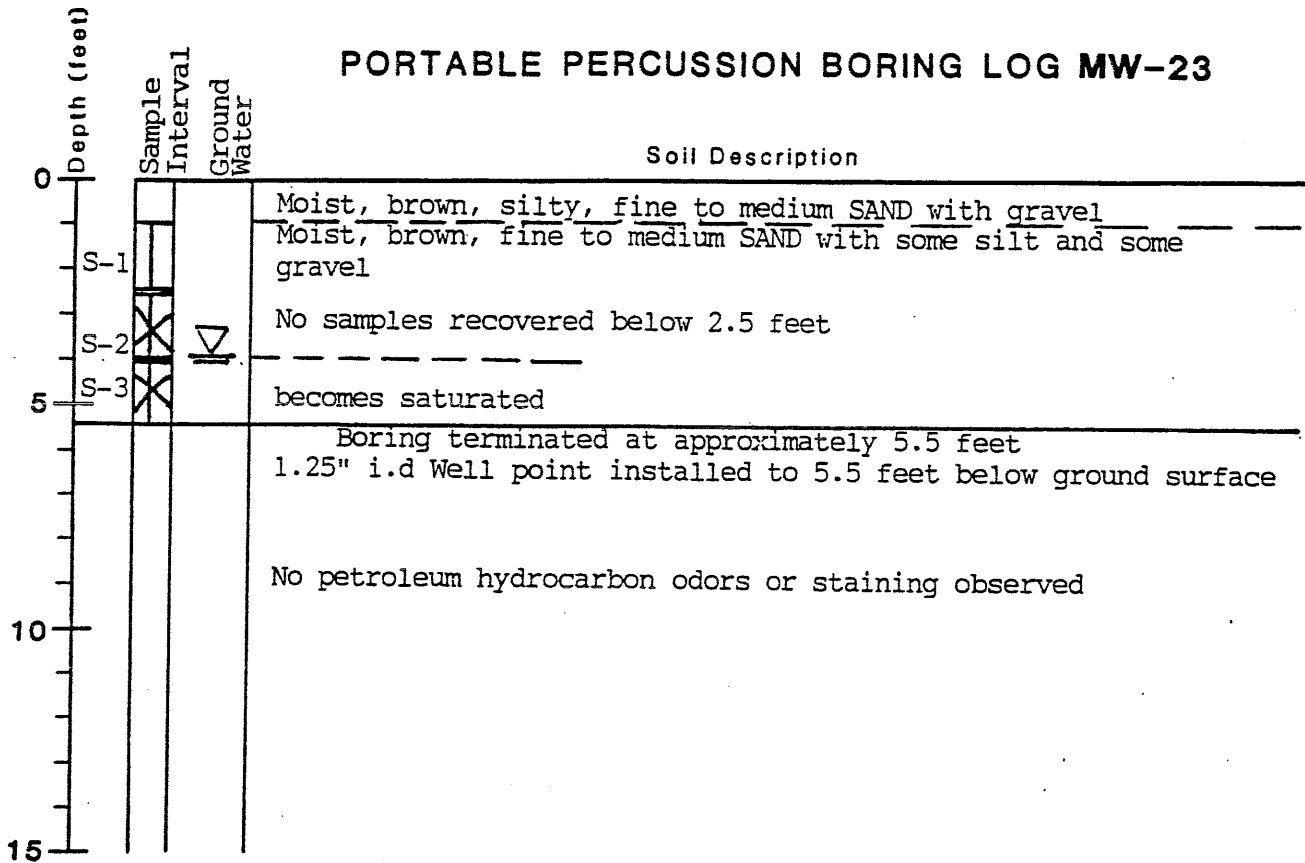

## PORTABLE PERCUSSION BORING LOG MW-24

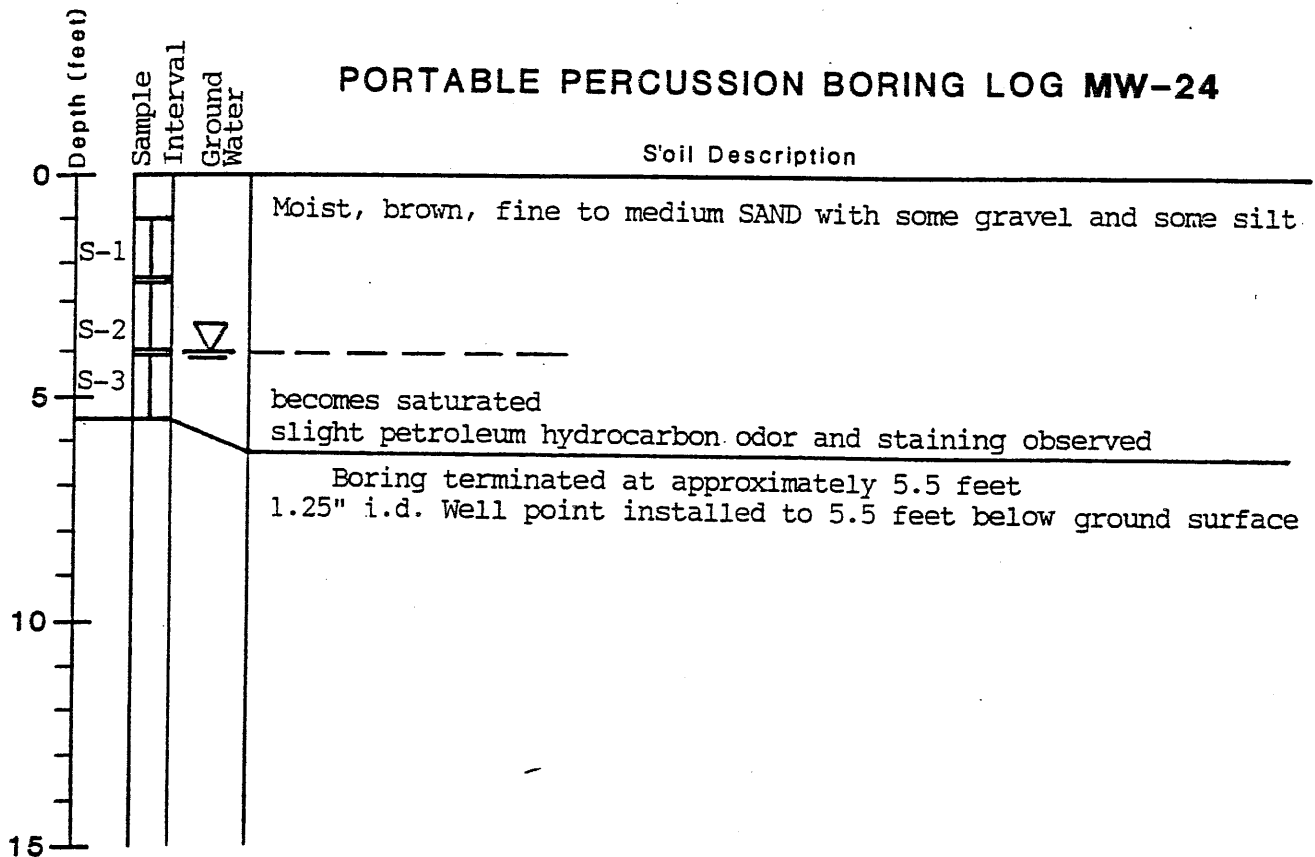

**RITTENHOUSE-ZEMAN &  
ASSOCIATES, INC.**

*Geotechnical Consultants*

1400 140th N.E.  
Belleve, Washington 98007  
(206) 746-8020



PORTABLE PERCUSSION BORING LOG MW-25

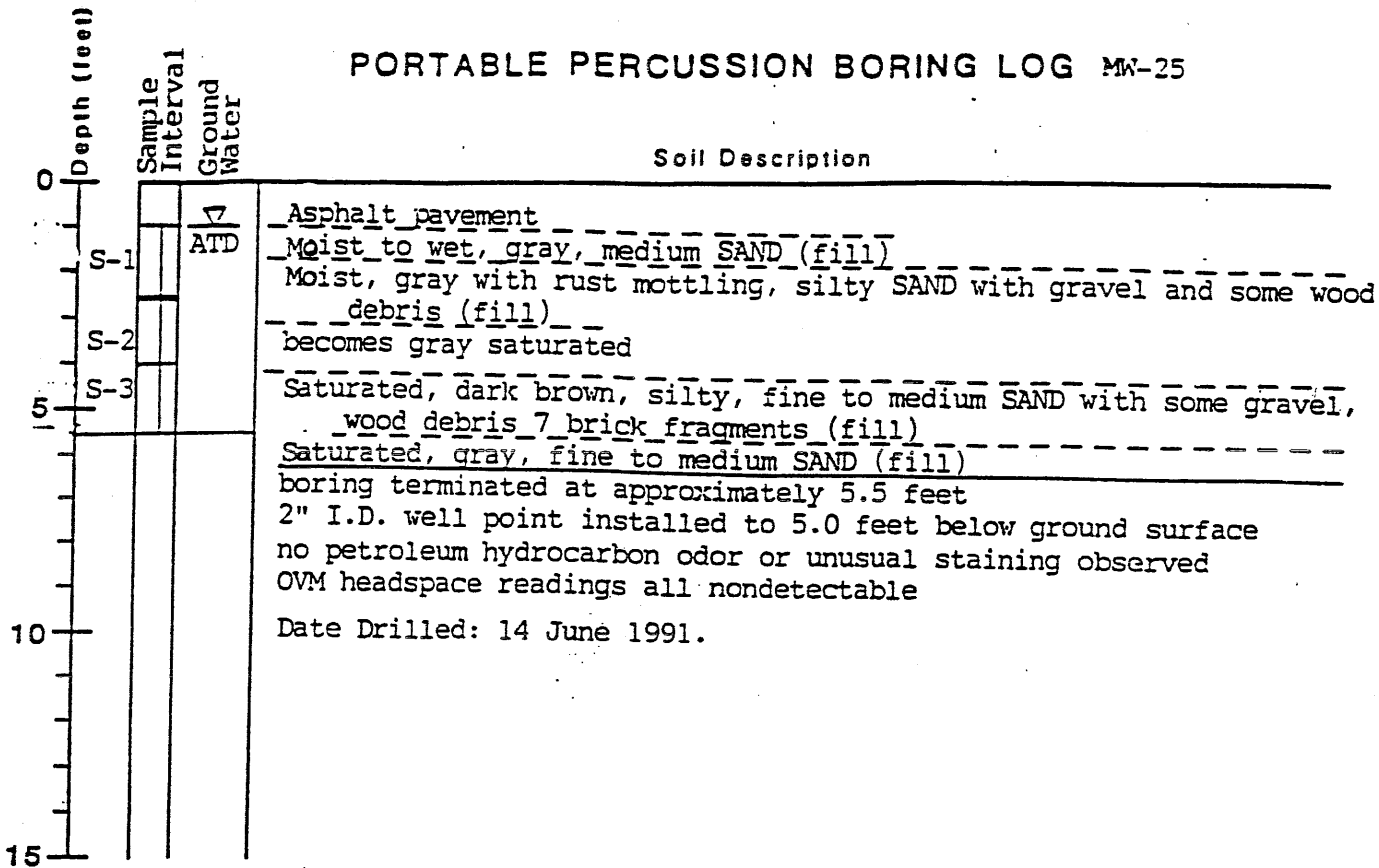

PORTABLE PERCUSSION BORING LOG MW-26

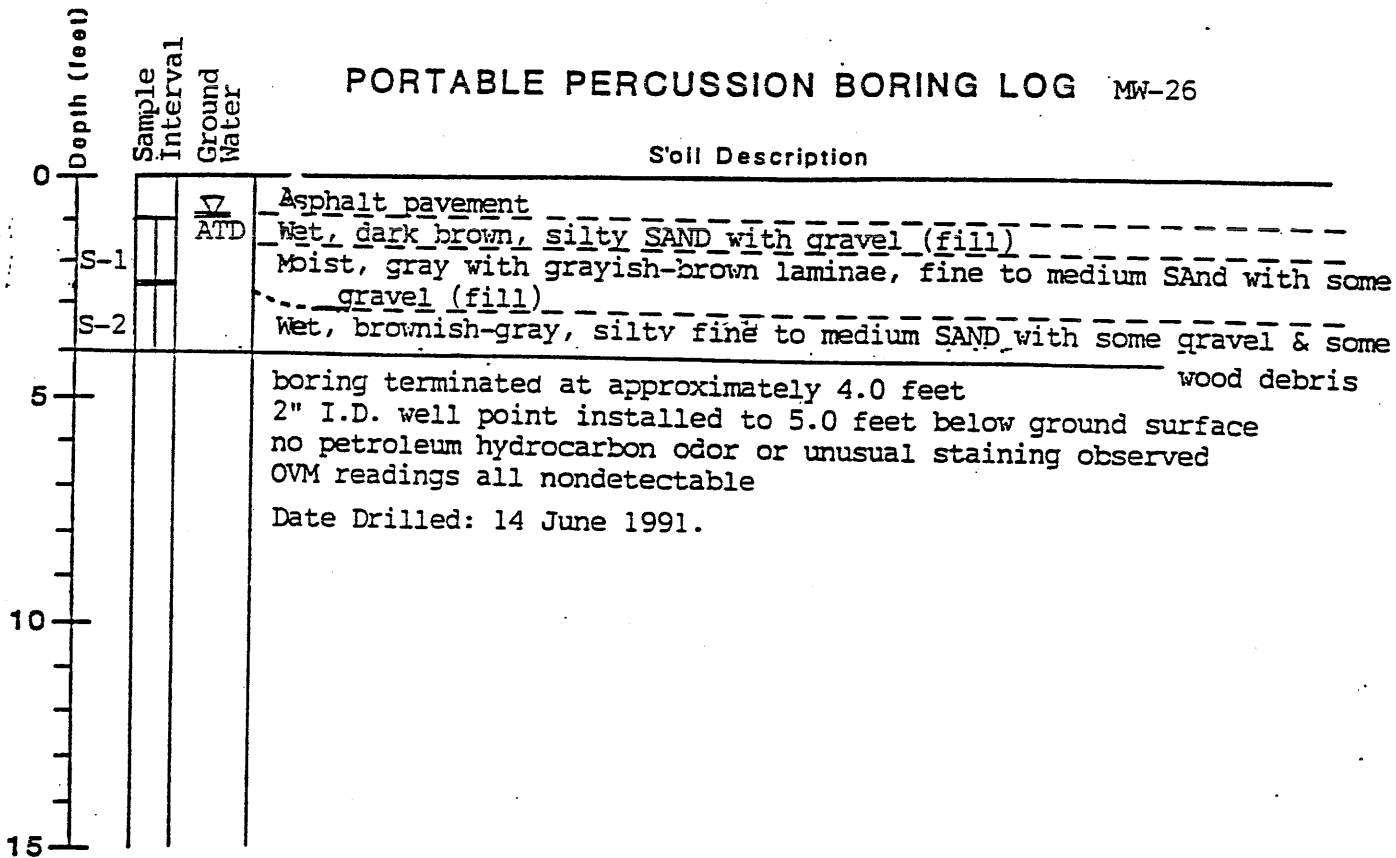

 ATD groundwater level at time of drilling

RITTENHOUSE-ZEMAN &  
ASSOCIATES, INC.

Geotechnical Consultants

1400 140th N.E.  
Bellerue, Washington 98007  
(206) 746-8020



Elevation reference: Well completed: *20 June 1991*  
 Ground surface elevation: Casing elevation:

AS-BUILT DESIGN

TESTING

DEPTH (feet)	SOIL DESCRIPTION	SAMPLE TYPE	SAMPLE NUMBER	BLOW COUNTS	QVM READING	GROUND WATER
0	2" Asphalt.					
0 - 5	Medium dense, moist, gray, silty fine SAND with hydrocarbon odor		S-1	15		ATD
5 - 10	Loose, wet, brown, PEAT with oily sheen and hydrocarbon odor		S-2	2		
10 - 13.5	Loose, moist, gray, medium SAND hydrocarbon odor and sheen		S-3	4		
13.5 - 15	Boring terminated at 13.5 feet.					
15 - 20						
20 - 25						
25 - 30						

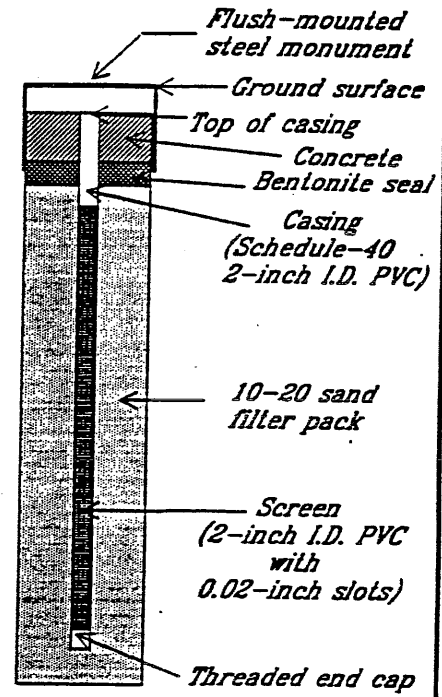

8015  
418.1  
BTEX  
6010

8015  
418.1  
BTEX  
6010

LEGEND

I 2-inch O.D. split-spoon sample

▽ ATD Observed groundwater level (ATD = at time of drilling)

8015  
418.1  
BTEX  
6010 Soil Analysis (EPA Method shown)

**RZA** RITTENHOUSE-ZEMAN & ASSOCIATES, INC.  
 Geotechnical & Environmental Consultants  
 1400 140th Ave NE  
 Bellevue, Washington 98005

Elevation reference: Well completed: 20 June 1991  
 Ground surface elevation: Casing elevation:

AS-BUILT DESIGN

TESTING

DEPTH (feet)	SOIL DESCRIPTION	SAMPLE TYPE	SAMPLE NUMBER	BLOW COUNTS	OVM READING	GROUND WATER
0	2" Asphalt.					
	3 inches brown/gray sandy GRAVEL					
5	Loose, moist, gray silty fine SAND		S-1	2		ATD
10	Loose, moist, brown, PEAT layer, strong hydrocarbon odor		S-2	2		
	Loose, moist to wet, brown, silty medium SAND with organics (peat); moderate hydrocarbon odor		S-3	2		
15	Boring terminated at 13.5 feet.					
20						
25						
30						

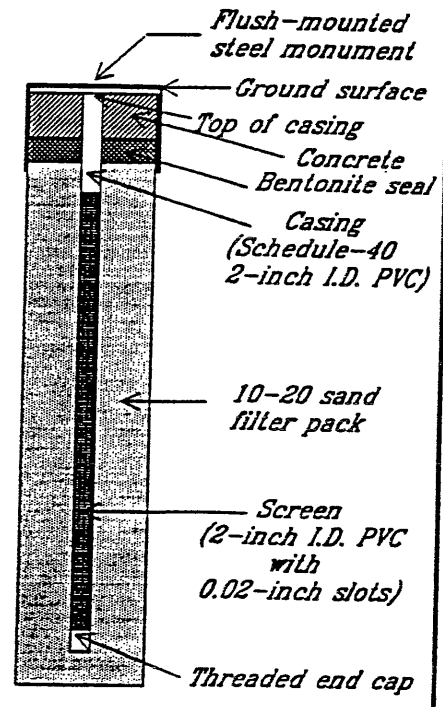

8015  
418.1  
BTEX  
6010

8015  
418.1  
BTEX  
6010

LEGEND

I 2-inch O.D. split-spoon sample  
 Soil Analysis (EPA Method shown)

▼  
ATD Observed groundwater level (ATD = at time of drilling)

**RZA** RITTENHOUSE-ZEMAN & ASSOCIATES, INC.  
 Geotechnical & Environmental Consultants  
 1400 140th Ave NE  
 Bellevue, Washington 98005

Drilling started: 20 June 1991

Drilling completed: 20 June 1991

Logged by: JK

Elevation reference:  
 Ground surface elevation: Well completed: *20 June 1991*  
 Casing elevation:

AS-BUILT DESIGN

TESTING

DEPT (feet)	SOIL DESCRIPTION	SAMPLE TYPE	SAMPLE NUMBER	BLOW COUNTS	QVM READING	GROUND WATER
0	2" to 3" Asphalt.					
	Loose, moist, gray, sandy, gravel					
5	Loose, moist, gray fine sandy SILT grading into silty fine sand	S-1	3			ATD
10	Loose, wet, black oil-saturated PEAT with wood	S-2	5			
		S-3	50/3"			

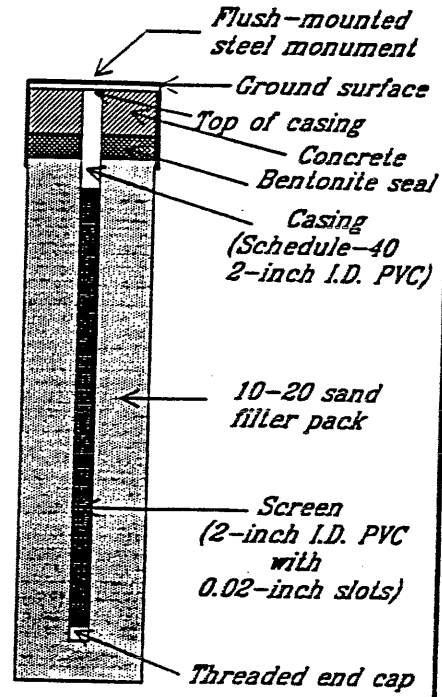

8015  
418.1  
BTEX  
6010

8015  
418.1  
BTEX  
6010

Boring terminated at 13.5 feet.

LEGEND

I 2-inch O.D. split-spoon sample

▽  
ATD Observed groundwater level (ATD = at time of drilling)

8015  
418.1  
BTEX  
6010 Soil Analysis (EPA Method shown)

× Sample not recovered



RITTENHOUSE-ZEMAN & ASSOCIATES, INC.  
 Geotechnical & Environmental Consultants  
 1400 140th Ave NE  
 Bellevue, Washington 98005

Drilling started: *20 June 1991*

Drilling completed: *20 June 1991*

Logged by: *JK*



Elevation reference: Well completed: *20 June 1991*  
 Ground surface elevation: Casing elevation:

AS-BUILT DESIGN

TESTING

DEPTH (feet)	SOIL DESCRIPTION	SAMPLE TYPE	SAMPLE NUMBER	BLOW COUNTS	QVM READING	GROUND WATER
0	2" Asphalt.					
	Loose, moist, gray, silty SAND					
	Loose, moist, gray, silty fine SAND	⊗	S-1	5		ATD
5	Loose, black, oily wood and PEAT					
	Very loose, wet, oily, gray medium SAND with organics (wood and peat)		S-2	2		
10	Loose, wet (oily), black/brown PEAT and wood		S-3	8		
15	Boring terminated at 13.5 feet.					
20						
25						
30						

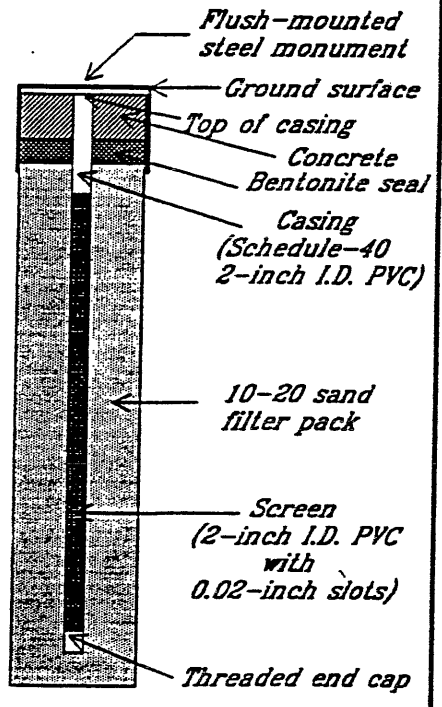

8015  
418.1  
BTEX  
6010

8015  
418.1  
BTEX  
6010

LEGEND

I 2-inch O.D. split-spoon sample

▼  
ATD Observed groundwater level (ATD = at time of drilling)

8015  
418.1  
BTEX  
6010  
Soil Analysis (EPA Method shown)

⊗ Sample not recovered

**RZA** RITTENHOUSE-ZEMAN & ASSOCIATES, INC.  
 Geotechnical & Environmental Consultants  
 1400 140th Ave NE  
 Bellevue, Washington 98005

Drilling started: *20 June 1991*

Drilling completed: *20 June 1991*

Logged by: *JK*

PROJECT: *Everett Mobil Bulk Plant* W.O. 11-04558-04 WELL NO. MW-3

Elevation reference: 100.00 feet  
 Ground surface elevation: Unknown

Well completed: 07 December 1993  
 Casing elevation: 98.58 feet

AS-BUILT DESIGN

TESTING

DEPTH (feet)	SOIL DESCRIPTION	SAMPLE TYPE	SAMPLE NUMBER	BLOW COUNTS	OVM READING	GROUND WATER
0	Asphaltic Concrete					
0 - 5	Medium dense, wet, brownish-gray, fine SAND with gravel (Fill). Slight petroleum-like odor observed		S-1	25	5	
5 - 10	Loose, wet to saturated, dark greenish-gray, SAND with some gravel and wood debris (Fill)		S-2	6	5	
10 - 15	Medium dense, saturated, dark gray, medium SAND with wood debris		S-3	22	5	
15	Bottom of boring at 15 feet.					
20						
25						
30						

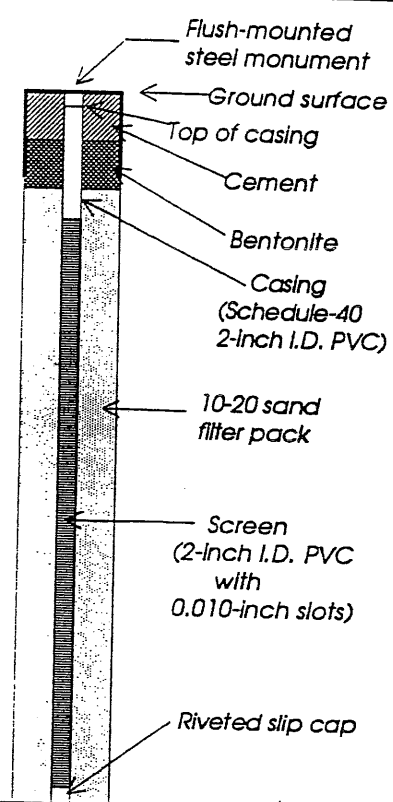

LEGEND

- 2-inch O.D. split-spoon sample
- Observed groundwater level  
 0/00/00 0/00/00 = date observed

**RZA AGRA, Inc.**  
 Geotechnical & Environmental Group

11335 NE 122nd Way, Suite 100  
 Kirkland, Washington 98034-6918

Drilling started: 07 December 1993 Drilling completed:

07 December 1993 Logged by: TJP

PROJECT: *Everett Mobil Bulk Plant W.O. 11-04558-04* WELL NO. MW-32

Elevation reference: 100.00 feet  
 Well completed: 07 December 1993  
 Ground surface elevation: Unknown  
 Casing elevation: 99.17 feet

AS-BUILT DESIGN

Page 1 of 1

DEPTH (feet)	SOIL DESCRIPTION	SAMPLE TYPE	SAMPLE NUMBER	BLOW COUNTS	OVM READING	GROUND WATER
0	Gravel surface					
5	Medium dense, wet to saturated, greenish-gray, gravelly, medium SAND (Fill)		S-1	13	5	12/8/93
10	Medium dense, saturated, grayish-dark brown, medium SAND with gravel, some silt and wood fragments		S-2	17	5	
15	Medium dense, saturated, grayish-dark brown, silty, fine to medium SAND with some gravel and wood fragments		S-3	17	5	
15	Bottom of boring at 15 feet. No unusual staining or petroleum-like odors observed.					
20						
25						
30						

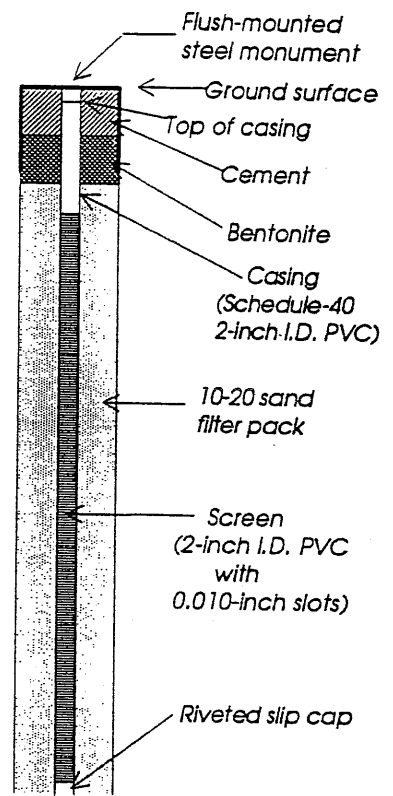

TESTING

LEGEND

- 2-inch O.D. split-spoon sample
- Observed groundwater level  
0/00/00 = date observed

**RZA AGRA, Inc.**  
 Geotechnical & Environmental Group

11335 NE 122nd Way, Suite 100  
 Kirkland, Washington 98034-6918

PROJECT: *Everett Mobil Bulk Plant* W.O. 11-04558-04 WELL NO. MW-33

Elevation reference: 100.00 feet  
 Ground surface elevation: Unknown

Well completed: 07 December 1993  
 Casing elevation: 97.64 feet

AS-BUILT DESIGN

TESTING

DEPTH (feet)	SOIL DESCRIPTION	SAMPLE TYPE	SAMPLE NUMBER	BLOW COUNTS	OVM READING	GROUND WATER
0	Asphaltic Concrete					
0 - 5	Medium dense, wet to saturated, gray, medium to coarse SAND with some gravel (Fill)		S-1	21	5	▼ 12/8/93
5 - 7	Medium dense, saturated, greenish-gray, silty, fine to medium SAND (Fill)		S-2	11	5	
7 - 9	Loose, saturated, brown, silty PEAT		S-3	5	5	
9 - 11	Loose to medium dense, saturated, gray to brownish-gray, SAND with trace to some silt, gravel and wood fragments		S-4	8	5	
11 - 13	(Chunk of wood stuck in sample tube; S-5 blow count probably not representative)		S-5	50/ 5	5	
13 - 15			S-6	11	5	
15 - 17			S-7	6	5	
17 - 19			S-8	10	5	
19 - 21			S-9	17	5	
21 - 23			S-10	14	5	
23 - 25	Very stiff, saturated, brown, clayey SILT with organics (PEAT-Like)		S-11	17	5	
25 - 29	Bottom of boring at 29 feet.					

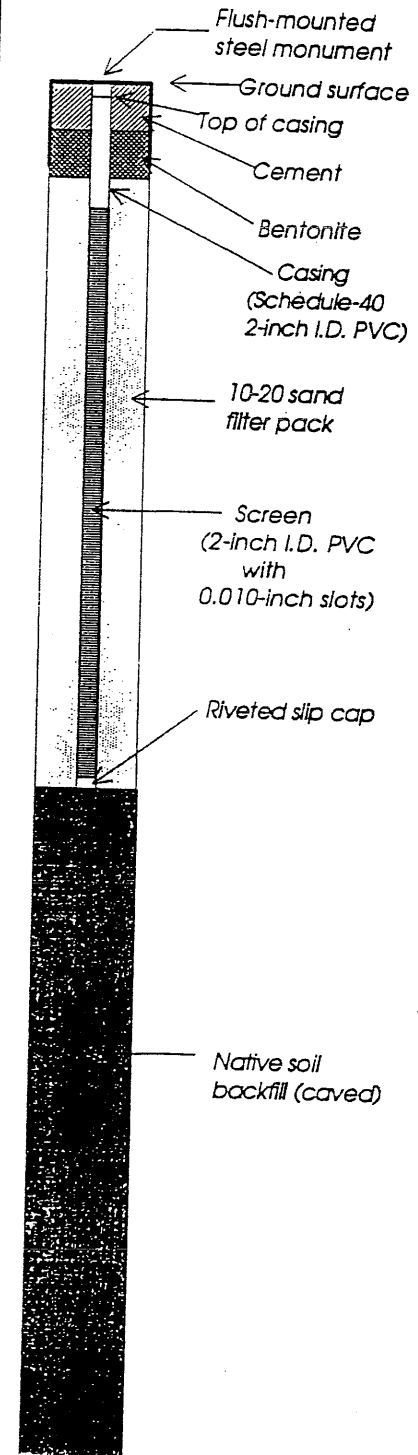

No unusual staining or petroleum-like odors observed.

LEGEND

— 2-inch O.D. split-spoon sample

▼ Observed groundwater level  
 0/00/00 0/00/00 = date observed

RZA AGRA, Inc.  
 Geotechnical & Environmental Group

11335 NE 122nd Way, Suite 100  
 Kirkland, Washington 98034-6918

Drilling started:

07 December 1993

Drilling completed:

07 December 1993

Logged by: TJP

PROJECT: *Everett Mobil Bulk Plant* W.O. 11-04558-04 WELL NO. MW-35

Elevation reference: 100.00 feet  
 Well completed: 06 December 1993  
 Ground surface elevation: Unknown  
 Casing elevation: 103.96 feet

AS-BUILT DESIGN

Page 1 of 1

DEPTH (feet)	SOIL DESCRIPTION	SAMPLE TYPE	SAMPLE NUMBER	BLOW COUNTS	OVM READING	GROUND WATER
0						
0 - 5	Dense, moist, gray, silty, fine to medium SAND with some gravel		S-1	38	0	
5 - 15	Loose, moist to saturated, gray, fine sandy SILT with some gravel		S-2	6	0	
15			S-3	4	0	
15	Bottom of boring at 15 feet. Field FT-IR analysis of samples S-1 and S-2 indicated TPH concentrations of <50 ppm.					
20						
25						
30						

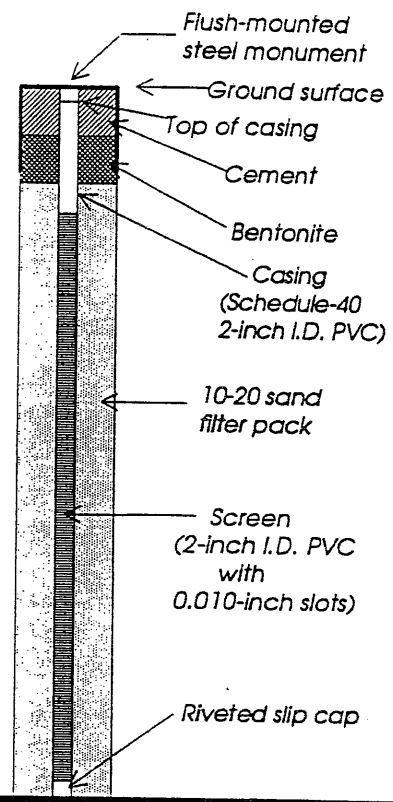

TESTING

LEGEND

I 2-inch O.D. split-spoon sample

▼ Observed groundwater level  
 0/00/00 0/00/00 = date observed

**RZA AGRA, Inc.**  
 Geotechnical & Environmental Group

11335 NE 122nd Way, Suite 100  
 Kirkland, Washington 98034-6918

PROJECT: *Everett Mobil Bulk Plant W.O. 11-04558-04 WELL NO. MW-36*

Elevation reference: *100.00 feet* Well completed: *06 December 1993*  
 Ground surface elevation: *Unknown* Casing elevation: *99.91 feet*

AS-BUILT DESIGN

DEPTH (feet)	SOIL DESCRIPTION	SAMPLE TYPE	SAMPLE NUMBER	BLOW COUNTS	OVM READING	GROUND WATER	AS-BUILT DESIGN	TESTING	
0									
0 - 5	Medium dense, moist, blackish-gray, silty, fine to medium SAND with some gravel		S-1	19	0	12/8/93			
5 - 10	Becomes very loose, with increasing silt content		S-2	2	0				
10 - 15	Wood debris		S-3	4	0				
15	Bottom of boring at 15 feet.								
20									
25									
30									

LEGEND

2-inch O.D. split-spoon sample

Observed groundwater level  
 0/00/00 0/00/00 = date observed

**RZA AGRA, Inc.**  
 Geotechnical & Environmental Group

11335 NE 122nd Way, Suite 100  
 Kirkland, Washington 98034-6918

PROJECT: *Everett Mobil Bulk Plant* W.O. 11-04558-04 WELL NO. MW-37

Elevation reference: 100.00 feet  
 Well completed: 06 December 1993  
 Ground surface elevation: Unknown  
 Casing elevation: 103.87 feet

AS-BUILT DESIGN

Page 1 of 1

DEPTH (feet)	SOIL DESCRIPTION	SAMPLE TYPE	SAMPLE NUMBER	BLOW COUNTS	OVM READING	GROUND WATER
0						
0 - 5	Medium dense, moist, gray, silty, fine to medium SAND with trace gravel		S-1	17	51	
5 - 10	Becomes very loose, saturated; strong petroleum-like odor		S-2	3	57	
10 - 15	Very loose, saturated, reddish-brown, medium to coarse SAND with some silt, trace gravel and organics; petroleum seepage observed		S-3	3	34	
15	Bottom of boring at 15 feet.					
20						
25						
30						

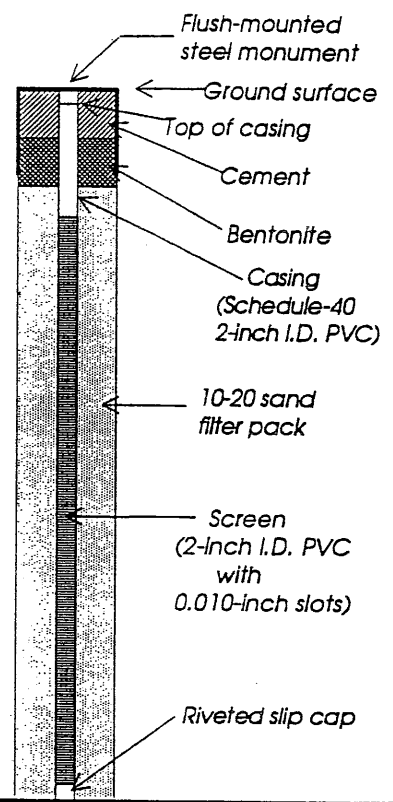

TESTING

LEGEND

- 2-inch O.D. split-spoon sample
- Observed groundwater level  
0/00/00 0/00/00 = date observed





**RZA AGRA, Inc.**  
 Geotechnical & Environmental Group

11335 NE 122nd Way, Suite 100  
 Kirkland, Washington 98034-6918

Location reference: Unknown  
 Ground surface elevation: Unknown

Well completed: 05 June 1996  
 Casing elevation: Unknown

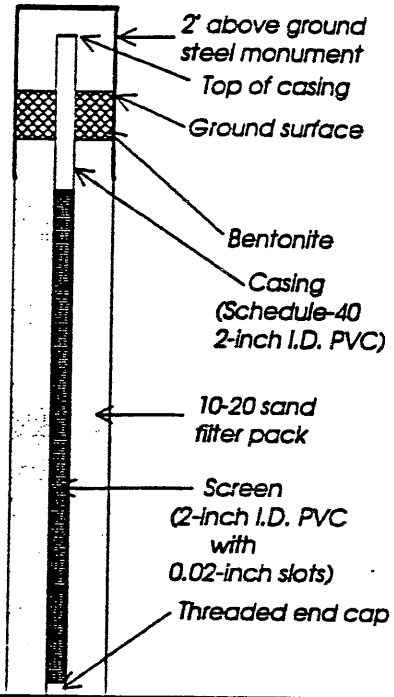

AS-BUILT DESIGN

DEPTH (feet)	SOIL DESCRIPTION	SAMPLE TYPE	SAMPLE NUMBER	BLOW COUNTS	OVM READING	GROUND WATER
0	Grass and Roots Loose, moist, dark brown, silty SAND with gravel (strong petroleum hydrocarbon-like odor)		MW-38/ 2.5			
5			MW-38/ 5.0	10	0.0	ATD
			MW-38/ 7.5	50/ 1"	0.0	
10	Medium dense, saturated, brown WOOD CHIPS with trace silt (Fill) (strong petroleum hydrocarbon-like odor)		MW-38/ 10.0	11	0.0	
12.5	Bottom of boring at 12.5 feet.					
15						
20						
25						
30						



TESTING

LEGEND

-  2-inch O.D. split spoon sample
-  Grab sample

-  Observed groundwater level
- ATD = at time of drilling

**AGRA**  
 Earth & Environmental  
 11335 NE 122nd Way, Suite 100  
 Kirkland, Washington 98034-6918



LOCATION VRW-1

**AGRA**  
Earth & Environmental

HOLE NO. VRW-1  
SHEET L OF 1  
TOTAL DEPTH 15.0  
DATE BEGUN 6/5/96  
DATE COMPLETED 6/5/96

WEATHER partly cloudy, 50's

**TEST BORING LOG**

SAMPLING		GROUNDWATER TABLE		EST. NAME	MOBILE/ADC	
DATE	6/5/96	DEPTH (FEET)	6.7	PROJECT NUMBER	11-04558-09	T 17
TIME	0930			ENGINEER	RAL	
				INSTALLER AREA	CASCADE	
				METHOD USED	HSA	
SAMPLING METHOD				STANDARD PENETRATION TEST T-TUBE R-RING		
				DEM		

**SOIL DESCRIPTION**

GRASS AND ROOTS OVER  
BACKFILL BENTONITE TO APPROX. 5.0 Feet

VRW-1	15	7	6	5.0	6	1	5m	dense, saturated, dark brown silty SAND with GRAVEL (5m) - wood debris, free product (oil), strong oil. NO SAMPLE FOR HEADSPACE
VRW-1	8	6	6	7.5	6	1	pt	stiff, <del>moist</del> saturated, brown PEAT - trace silt, strong odor. HNU = 14 ppm
VRW-1	12	11	8	10.0	11	1	sp	m. dense, saturated, grey brown SAND with silt (SP) - trace peat, wood debris from 10-10.5 feet, strong odor. HNU = 40 ppm
VRW-1	6	6	5	12.5	6	1	pt	stiff, saturated, brown PEAT - trace silt, strong odor. HNU = 5 ppm

DRILL OUT TO 15' MENING SAND  
0.5 THREADED CAP.

140 lb - 30" Drop

BORING  
LOG  
SUMMARY



LOCATION

OBSERVED BY PATL  
DRILLER/INSTALLER CASCADE

PROJECT No. 11-04558-09  
PROJECT NAME MOBILE/AD  
BORING/WELL I.D. URW-1  
DATE 6/5/96

SOIL TYPE DEPTH

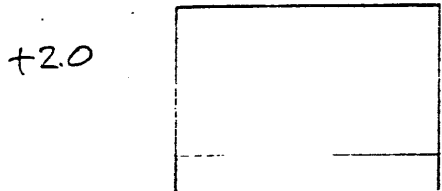

ABOVE GROUND RISER HEIGHT (IF APPLICABLE) 9  
MONUMENT TYPE (IF APPLICABLE)  
WELL CAP TYPE locking

0 SURFACE



~~GROUT TYPE/=SACKS~~  
BENTONITE SEAL /=SACKS

1

WELL CASING I.D. 4"  
TYPE OF CASING Schedule 40 PVC  
TYPE OF CONNECTION Thread-d

2

FILTER PACK/SIZE/=SACKS 6x12

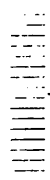

WELL SCREEN I.D. 4"  
TYPE OF SCREEN "V" screen  
SLOT SIZE 0.030

DIAMETER OF BOREHOLE 12"

140  
145  
145

ENDCAP TYPE threaded (0.5' pointed)

REMARKS



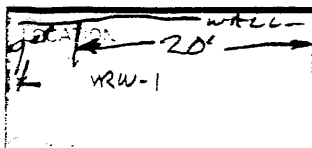

**AGRA**  
Earth & Environmental

HOLE NO. RW-1  
SHEET 1 OF 1  
TOTAL DEPTH 15.0  
DATE BEGUN 6/5/96  
DATE COMPLETED 6/5/96

THW partly cloudy, 50's

**TEST BORING LOG**

SAMPLING		GROUNDWATER TABLE		PROJECT NAME	
DATE	6/5/96	DEPTH IN FEET	6.7	PROJECT NUMBER	MOBIL/ADC 11-04558-09 T17
TIME	0930	DATE	6/5/96	GEOLOGIST/ENGINEER	RAL
DRILLING CONTRACTOR	CASCADE	SAMPLING METHOD	SPT=STANDARD PENETRATION TEST T=TUBE R=RING	METHOD USED	HSA DEM

**SOIL DESCRIPTION**

GRASS AND ROOTS OVER  
BACKFILL BENTONITE TO APPROX. 5.0 Feet

RW-1	15	7	6	5m	m. dense, saturated, dark brown silty SAND with GRAVEL (5m) - wood debris, free product (oil), strong oil. NO SAMPLE FOR HEADSPACE
RW-1	8	6	6	pt	stiff, <del>moist</del> saturated, brown PEAT - trace silt, strong odor HNU = 14 ppm
RW-1	12	11	8	sp	m. dense, saturated, grey brown SAND with silt (SP) - trace peat, wood debris from 10-10.5 feet, strong odor. HNU = 40 ppm
RW-1	6	6	5	pt	stiff, saturated, brown PEAT - trace silt, strong odor HNU = 5 ppm

DRILL OUT TO 15'. HEAVY SAND  
0.5 THREADED CAP.

140 lb - 30" Drop

BORING  
LOG  
SUMMARY



**MONITORING WELL AS-BUILT REPORT**

LOCATION \_\_\_\_\_

PROJECT No. 11-04558-09

OBSERVED BY PAL

PROJECT NAME MOBILE/AD

DRILLER/INSTALLER CASCADE

BORING/WELL I.D. URW-1

DATE 6/5/96

SOIL TYPE    DEPTH

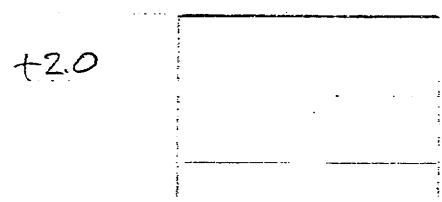

ABOVE GROUND RISER HEIGHT (IF APPLICABLE) \_\_\_\_\_

MONUMENT TYPE (IF APPLICABLE) \_\_\_\_\_

WELL CAP TYPE locking

0 SURFACE



~~GROUT TYPE~~ = SACKS \_\_\_\_\_

1

BENTONITE SEAL = SACKS \_\_\_\_\_

2

WELL CASING I.D. 4"

TYPE OF CASING Schedule 40 PVC

TYPE OF CONNECTION Threaded

FILTER PACK/SIZE = SACKS 6x12

WELL SCREEN I.D. 4"

TYPE OF SCREEN "V" screen

SLOT SIZE 0.030

DIAMETER OF BOREHOLE 12"

14.0

14.5

14.5

ENDCAP TYPE threaded (0.5' points)

REMARKS \_\_\_\_\_



LOG OF  
EXPLORATORY BORING

Project No: 05-487-001

Boring No: AD-01

Date: 1-15-90

Client: American Distributing Co.

Driller: D. Alford

Location: Bulk Terminal-Everett, WA

Drilling Method: Hand Auger

Hole Diameter: 2"

Logged by: D. Alford

Page No: 1 of 1

Installation Data: Backfill with enviroplug

1 location of boring:

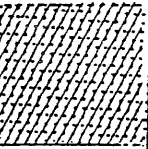
epth (ft)	Graphic Log	Blow/ft	Vapor Concen- tration (ppm)	Sample type and Depth	Soil Group Symbol (U.S.C.S.)	Water Level	Time	Date	Comments:
						3.0'			
0 -				Sample @ 0.5-1.0'	sp	Grass			
1 -						0.5-1.0 Sand, coarse grained, occasional gravel, very slight clay loose, moist, no odor.			
2 -						2.0' Sand, clayey, fine grained, grey brown, loose, very moist, moderate petroleum odor.			
3 -	 TD = 3.0'			Sample @ 3.0'	sc	2.5-3' Sand, clayey, occasional gravel, light grey brown, very moist, loose, strong petroleum odor.			
4 -						3' Sand, coarse grained, slightly clayey, some gravel, light grey wet, moderate petroleum odor.			
5 -						Groundwater at approximately 3'.			

LOG OF  
EXPLORATORY BORING

Project No: 05-487-001

Boring No: AD-02

Date: 1-15-90

Client: American Distributing Co.

Driller: D. Alford

Location: Bulk Terminal-Everett, WA

Drilling Method: Hand Auger

Hole Diameter: 2"

Logged by: D. Alford

Page No: 1 of 1

Installation Data: Backfill with enviroplug

Location of boring:

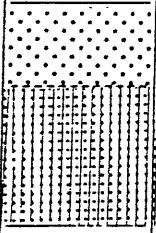
Depth (ft)	Graphic Log	Blow/ft	Vapor Concen- tration (ppm)	Sample type and Depth	Soil Group Symbol (U.S.C.S.)	Water Level	Time	Date	Comments:
						approx. 2.0'			
0 -				Sample @ 0.5-1.0'	sp				Grass 0.5-1.0' Sand, coarse grained with occasional gravel, saturated, slight petroleum odor.
1 -				Sample @ 2.5-3.0'	sm			2.5-3.0' Sand, coarse grained with grey/green clayey silt, organic debris, strong petroleum odor, iridescent sheen on water.	
2 -									
3 -	TD = 3.0'								
4 -									
5 -									
									Groundwater at approximately 2'





















LOG OF  
EXPLORATORY BORING

Project No: 05-487-001

Boring No: AD-12

Date: 1-16-90

Client: American Distributing Co.

Driller: D. Alford

Location: Bulk Terminal-Everett, WA

Drilling Method: Hand Auger

Hole Diameter: 2"

Logged by: D. Blaes

Page No: 1 of 1

Installation Data: Backfill with Enviroplug

Location of boring:

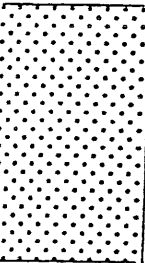
Depth (ft)	Graphic Log	Blow/ft	Vapor Concen- tration (ppm)	Sample type and Depth	Soil Group Symbol (U.S.C.S.)	Water Level	Time	Date	Comments:	
						Approx. 3.5'				
0 -				Sample @ 0.5-1.0'	sp	0.5-1.0' Sand, with gravel, medium grained, brown, loose, moist, no petroleum odor.				
1 -										
2 -				Sample @ 2.5-3.0'	sp		2.5-3.0' Sand, medium grained, gravelly, grey brown, loose, visible oil staining, strong diesel odor.			
3 -				Sample @ 3.0-3.5'			3.0-3.5' Sand, medium grained, gravelly, grey, wet, strong petroleum odor.			
4 -	TD = 3.5'									
5 -										
									Groundwater at approximately 3.5'	













LOG OF  
EXPLORATORY BORING

Project No: 05-487-001

Boring No: AD-18

Date: 1-17-90

Client: American Distributing Co.

Driller: D. Alford

Location: Bulk Terminal-Everett, WA

Drilling Method: Hand Auger

Hole Diameter: 2"

Logged by: D. Blaes

Page No: 1 of 1

Installation Data: Backfill with Enviroplug

Location of boring:

Depth (ft)	Graphic Log	Blow/ft	Vapor Concentration (ppm)	Sample type and Depth	Soil Group Symbol (U.S.C.S.)	Water Level	Time	Date	Comments:
						Approx. 4.5'			
0 -				Sample @	sc				0.5-1.0' Sand, clayey, brown, slightly cohesive, moist, no odor
1 -				0.5-1.0'	sc				1.0-4.0' Sand, medium grained, clayey, brown to grey, organic debris, medium dense, moist, moderate diesel odor at 2.0-3.0'
2 -									
3 -									
4 -					Sample @	sc			
5 -	TD = 4.5'								Groundwater at approximately 4.5'



## TEST PIT LOGS

Depth (feet)

Soil Classification

11-04558-04

### Test Pit TP-1

0.0 - 0.5 Gravel surface  
0.5 - 1.5 Loose, wet, dark grayish-brown, silty SAND with gravel (Fill)  
1.5 - 3.5 Loose, wet to saturated, gray, coarse SAND with gravel  
Strong petroleum-like odor and black oily staining observed;  
Test pit terminated at approximately 3.5 feet  
Moderate groundwater and liquid petroleum hydrocarbon seepage below 3 feet  
  
Field FT-IR analysis indicated > 4,600 ppm TPH at 3 foot depth

### Test Pit TP-2

0.0 - 0.5 Gravel surface; old A/C at 0.5 feet  
0.5 - 4.0 Loose, wet to saturated, gray, coarse SAND with gravel  
No unusual odors or staining observed;  
Test pit terminated at approximately 4.0 feet  
Moderate groundwater seepage observed below 3.5 feet  
A large block of concrete encountered at a depth of approximately 1 foot  
  
Field FT-IR analysis indicated 30 ppm TPH at 3.5 foot depth

### Test Pit TP-3

0.0 - 0.5 Gravel surface old A/C at 0.5 feet  
0.5 - 4.0 Loose, wet to saturated, gray, coarse SAND with gravel  
Test pit terminated at approximately 4.0 feet  
Moderate groundwater seepage observed below 3.5 feet  
Slight surface sheen observed on groundwater emanating from the east side of the test pit  
  
Field FT-IR analysis indicated 80 ppm TPH at 3.5 foot depth



Depth (feet)      Soil Classification

Test Pit TP-4

0.0 - 0.5      Gravel surface  
0.5 - 4.0      Loose, wet to saturated, gray, coarse SAND with gravel  
Test pit terminated at approximately 4.0 feet  
Moderate groundwater seepage observed below 3.5 feet  
No unusual odors or staining observed

Field FT-IR analysis indicated 30 ppm TPH at 3.5 feet

Test Pit TP-5

0.0 - 0.5      Gravel surface  
0.5 - 4.0      Loose, wet to saturated, gray, coarse SAND with gravel  
Test pit terminated at approximately 4.0 feet  
Moderate groundwater seepage observed below 3.5 feet  
No unusual odors or staining observed

Field FT-IR analysis indicated 50 ppm TPH at 3.5 feet

Date excavated: 8 December 1993

Logged by: TJP

## Backhoe Test Pit Logs

### TP-1-96

Gray, moist to wet, silty SAND with gravel and some cobbles. Met with refusal at a depth of approximately 3.0 feet due to buried concrete. Slow seepage observed at approximately 1.5 feet. Soil exhibits a petroleum hydrocarbon-like odor. After approximately 1.5 hours, discontinuous blebs of LPH were observed on the water accumulated in the test pit.

### TP-2-96

Brown, moist to wet, silty SAND with gravel and some wood and metal debris; becomes gray below approximately 1.0 feet. Slow seepage observed at approximately 1.0 feet and again below approximately 4.0 feet. Soil exhibits a petroleum hydrocarbon-like odor. After approximately 1.5 hours, discontinuous blebs of LPH were observed on the water accumulated in the test pit. Test pit terminated at approximately 4.5 feet.

### TP-3-96

Gray, moist, gravelly SAND with some silt with scattered wood and brick debris. Underlain at approximately 4.0 feet by gray, wet to saturated, cohesive, silty, fine to medium SAND. Slow seepage observed at approximately 1.5 feet. Moderate seepage observed below a depth of approximately 6.0 feet. Soil exhibits a petroleum hydrocarbon-like odor. No LPH observed; sheen present of water accumulated in the test pit. Test pit terminated at approximately 6.5 feet.

## Backhoe Test Pit Logs

### TP-4-96

Brown, moist to wet, silty SAND with some gravel; becomes gray with a petroleum hydrocarbon-like odor below 2.5 feet. Slow seepage observed below approximately 5.0 feet. Discontinuous blebs of LPH observed on the groundwater accumulated in the bottom of the test pit. Test pit terminated at approximately 6.0 feet.

### TP-5-96

Brown, moist to wet, silty SAND with some gravel with some brick and glass debris; becomes gray with a petroleum hydrocarbon-like odor below 2.5 feet. Slow seepage observed below approximately 5.0 feet. Encountered a 4-inch diameter clay pipe at approximately 4.5 feet. LPH and water drained from the pipe for approximately 10 to 15 minutes after digging through the pipe. Discontinuous blebs of LPH observed on the groundwater accumulated in the bottom of the test pit. The LPH appeared to originate from both seepage from the soil and infiltration from the broken clay pipe. Test pit terminated at approximately 6.0 feet.

### TP-6-96

Brownish-gray, moist to wet, silty SAND with gravel and wood debris; becomes gray with a petroleum hydrocarbon-like odor below approximately 2.0 feet. Moderate to rapid LPH and groundwater seepage observed below approximately 4.0 feet. Approximately 0.02 feet of LPH accumulated as a continuous layer on top of groundwater pooled inside of the test pit. Test Pit terminated at approximately 6.0 feet.

### TP-7-96

Moist to wet, dark brown to black, SAND with some silt and gravel; strong petroleum hydrocarbon-like odor observed. Moderate LPH and groundwater seepage observed below 3.0 feet. LPH accumulated as a continuous layer on top of the groundwater pooled in the test pit. LPH thickness was approximately 0.10 feet. Test pit terminated at approximately 4.0 feet.

**APPENDIX D**

**SELECTED GEOTECHNICAL BORING LOGS**

# LOG OF BORING NO. DM-7-99

**PROJECT:** California Street Overcrossing  
**PROJECT NO:** 04333-041-189  
**PROJECT LOCATION:** Everett, WA  
**CLIENT NAME:** Port of Everett  
**DATE STARTED:** December 8, 1999  
**DATE COMPLETED:** December 8, 1999  
**DRILLING CONTRACTOR:** Cascade Drilling  
**DRILLER:** Scott Kruger  
**DRILLING METHOD:** Hollow Stem Auger to Mud Rotary  
**SAMPLING METHOD:** D&M U, 300lb hammer, 30" drop

**WATER LEVEL:**  $\nabla$  7.00 ft  
  
**ELEVATION:** 18 ft  
**TOTAL DEPTH:** 45.00 ft  
**WEATHER:** Light rain  
**FIELD ENGINEER:** BBS  
**CHECKED BY:**

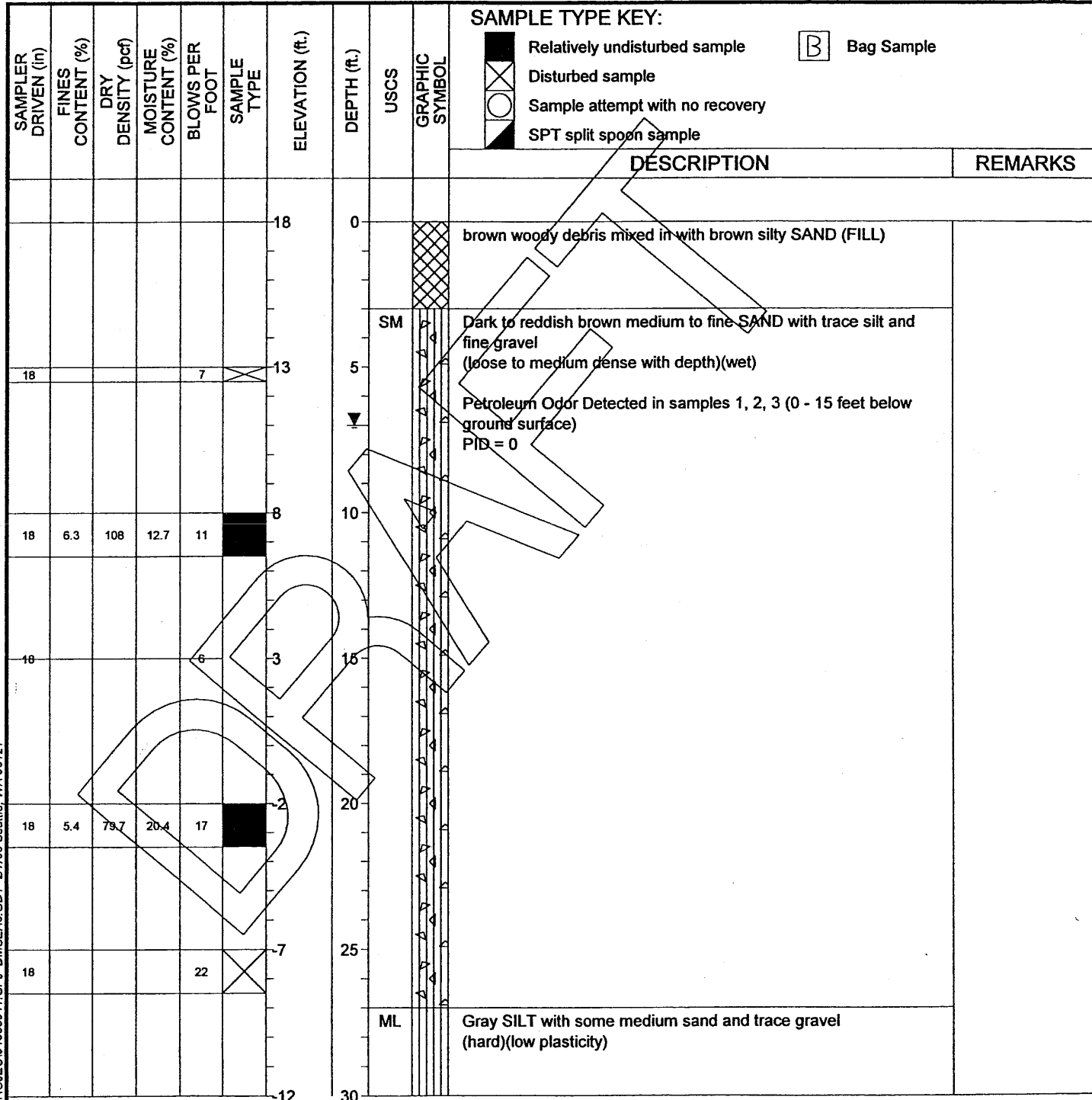

**SAMPLE TYPE KEY:**

- Relatively undisturbed sample
- Disturbed sample
- Sample attempt with no recovery
- SPT split spoon sample
- B Bag Sample

**NOTES:** PID is a Photo Ionization Detector that detects the presence of volatile hydrocarbons

093 DRAFT K:11630-PROJECT\04333041.GPJ DM5E46.GDT 2/7/00 Seattle, WA 98121













LOG OF BORING DM-7-99

FIGURE A-9.1

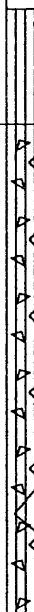
PROJECT: California Street Overcrossing  
 PROJECT NO: 04333-041-189  
 PROJECT LOCATION: Everett, WA

FIELD ENGINEER: BBS  
 CHECKED BY:

SAMPLER DRIVEN (in)	FINES CONTENT (%)	DRY DENSITY (pcf)	MOISTURE CONTENT (%)	BLOWS PER FOOT	SAMPLE TYPE	ELEVATION(ft.)	DEPTH (ft.)	USCS	GRAPHIC SYMBOL	SAMPLE TYPE KEY:	
										 Relatively undisturbed sample  Disturbed sample  Sample attempt with no recovery  SPT split spoon sample	 Bag sample
										DESCRIPTION	REMARKS
18		119.2	25.8	81		-12	30				
								SM		Brown medium SAND with some silt and trace of fine gravel (very dense)(wet)	
12		107.2	15	50/6"		-17	35				
18		109.8	11.4	68		-22	40				
10				100/10"		-27	45				
										End of Boring at 46 feet below ground surface Ground water encountered at 7 feet below ground surface	

NOTES: PID is a Photo Ionization Detector that detects the presence of volatile hydrocarbons

0B3 DRAFT K116310-PROJ/EC/04333041.GPJ DIMSEA6.GDT 2/7/00 Seattle, WA 98121

# LOG OF BORING NO. DM-8-99

**PROJECT:** California Street Overcrossing  
**PROJECT NO:** 04333-041-189  
**PROJECT LOCATION:** Everett, WA  
**CLIENT NAME:** Port of Everett  
**DATE STARTED:** December 1, 1999  
**DATE COMPLETED:** December 1, 1999  
**DRILLING CONTRACTOR:** Cascade Drilling  
**DRILLER:** Scott Kruger  
**DRILLING METHOD:** Hollow Stem Auger to Mud Rotary  
**SAMPLING METHOD:** D&M U, 300lb hammer, 30" drop

**WATER LEVEL:**  $\nabla$  5.00 ft  
  
**ELEVATION:** 18 ft  
**TOTAL DEPTH:** 50.00 ft  
**WEATHER:** Overcast, light rain  
**FIELD ENGINEER:** BBS  
**CHECKED BY:**

SAMPLER DRIVEN (in)	FINES CONTENT (%)	DRY DENSITY (pcf)	MOISTURE CONTENT (%)	BLOWS PER FOOT	SAMPLE TYPE	ELEVATION (ft.)	DEPTH (ft.)	USCS GRAPHIC SYMBOL	SAMPLE TYPE KEY:	
									DESCRIPTION	REMARKS
						18	0	SM/ML	Asphalt	
									Black SAND with some silt and trace fine gravel (fill)(very loose)(wet)	
									Petroleum Odor Detected in samples 1, 2 (0 - 10 feet below ground surface) PID = 0	
18	19.6			2		13				
18	5.1			5		8		SM	Reddish brown medium SAND with some gravel and trace silt (very dense)(wet)	
18		78	13.9	52		3				
18		119.3	16.9	87		2				
18		111.3	15.5	95		7				
						12	30			

NOTES: PID is a Photo Ionization Detector that detects the presence of volatile hydrocarbons

083 DRAFT K:\1630-PROJECT\04333041.GPJ DMSEA6.GDT 2/7/00 Seattle, WA 98121



**DAMES & MOORE**  
A DAMES & MOORE GROUP COMPANY

LOG OF BORING DM-8-99

FIGURE A-10.1

PROJECT: **California Street Overcrossing**

PROJECT NO: **04333-041-189**

PROJECT LOCATION: **Everett, WA**

FIELD ENGINEER: **BBS**

CHECKED BY:

Sheet 2 of 2

SAMPLER DRIVEN (ft)	FINES CONTENT (%)	DRY DENSITY (pcf)	MOISTURE CONTENT (%)	BLOWS PER FOOT	SAMPLE TYPE	ELEVATION(ft.)	DEPTH (ft.)	USCS	GRAPHIC SYMBOL	SAMPLE TYPE KEY:	
										DESCRIPTION	REMARKS
9	113.1	14.3	50/3"			12	30			Relatively undisturbed sample	Bag sample
6			50/6"			17	35			Disturbed sample	
18			29			22	40	ML		Gray SILT with trace fine to medium sand and fine gravel (very stiff)	
18	90.2		36			27	45	SM		Gray fine to medium SAND with some silt (very dense)(wet)	
18			50/6"			32	50			Relatively undisturbed sample	
										End of Boring at 51.5 feet below ground surface Ground water encountered at 5 feet below ground surface	

NOTES: PID is a Photo Ionization Detector that detects the presence of volatile hydrocarbons

DB3 DRAFT K:\16310-PROJECT\04333041.GPJ\_DMSEA6.GDT 27700 Seattle, WA 9/1/21



**LOG OF BORING DM-8-99**

FIGURE A-10.2



# MONITORING WELL NO. DM-6-99

**PROJECT:** California Street Overcrossing  
**PROJECT NO:** 04333-041-189  
**PROJECT LOCATION:** Everett, WA  
**CLIENT NAME:** Port of Everett  
**DATE STARTED:** December 6, 1999  
**DATE COMPLETED:** December 6, 1999  
**DRILLING CONTRACTOR:** Cascade Drilling  
**DRILLER:** Scott Kruger  
**DRILLING METHOD:** Hollow Stem Auger to Mud Rotary  
**SAMPLING METHOD:** D&M U, 300lb hammer, 30" drop

**WATER LEVEL:**  $\nabla$ 0.00 ft  
  
**ELEVATION:** +20.00  
**TOTAL DEPTH:** 55.00 ft  
**WEATHER:** Overcast, light rain  
**FIELD ENGINEER:** BBS  
**CHECKED BY:**

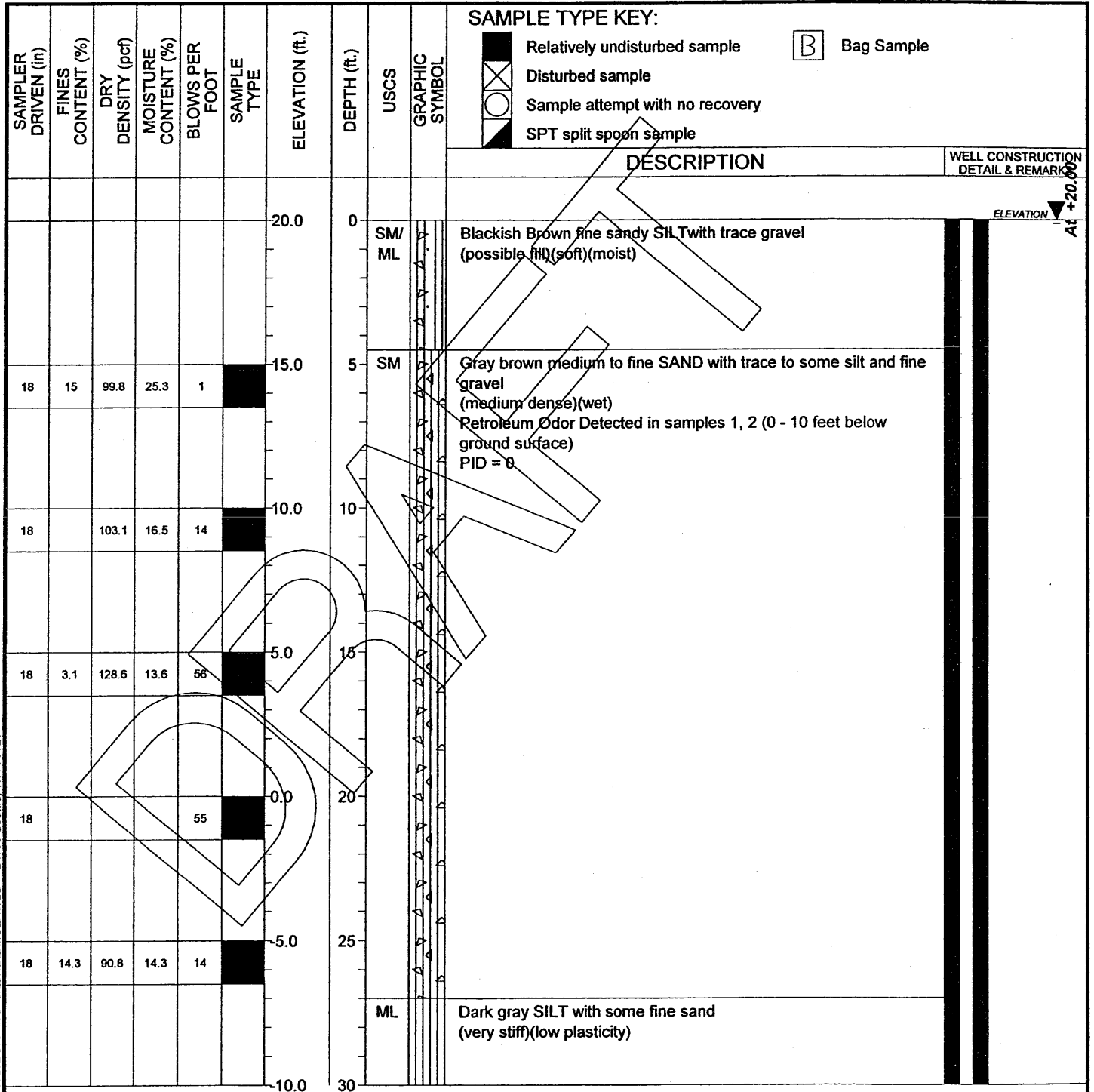

**SAMPLE TYPE KEY:**

- Relatively undisturbed sample
- Disturbed sample
- Sample attempt with no recovery
- SPT split spoon sample
- Bag Sample

**NOTES:** PID is a Photo Ionization Detector that detects the presence of volatile hydrocarbons

5/11/03/PT/FR/W/EL/1/6/RA/FR/04/6/00/04/3/29/41/2/FR/00/01/5E/6/GDT/2/7/00/Seattle, WA 98121



- WELL SYMBOL KEY:**
- Bentonite grout
  - Bentonite plug
  - Filter Pack
  - Well screen
  - Concrete plug

**MONITORING WELL DM-6-99**  
 FIGURE A-8.1

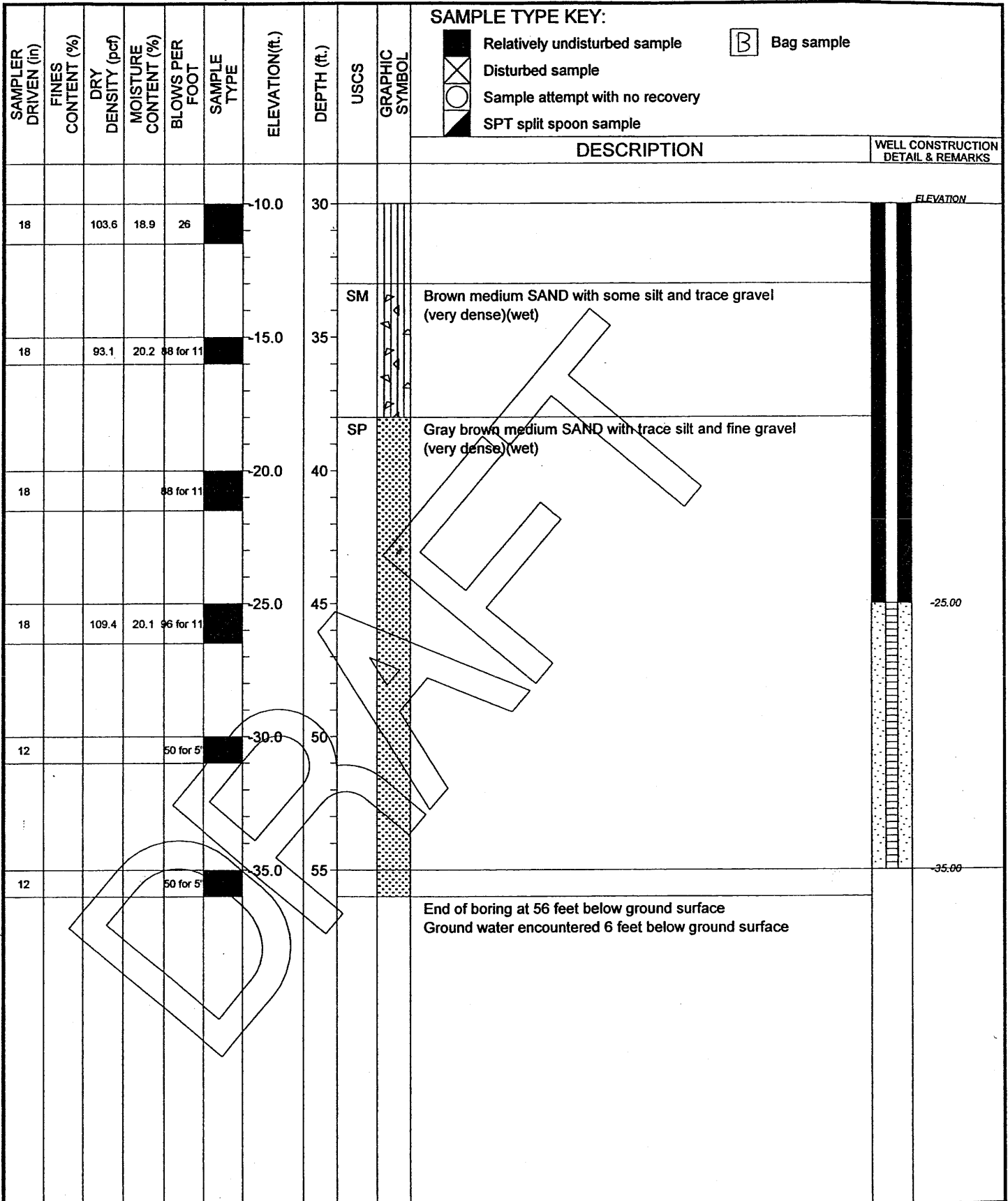

WELL DRAFT K:\16310-PROJ\JEC\04333041.GPJ DMSEA6.GDT 2/7/00 Seattle, WA 98121

NOTES: PID is a Photo Ionization Detector that detects the presence of volatile hydrocarbons



WELL  
SYMBOL  
KEY:

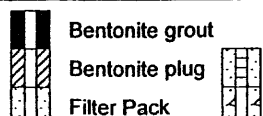

**MONITORING WELL DM-6-99**

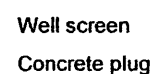

FIGURE A-8.2

**APPENDIX B  
BORING LOGS**

# LOG OF BORING NO. UG-1

PROJECT: **California Street Overcrossing**  
 PROJECT NO: **04333-041-189**  
 PROJECT LOCATION: **Everett, WA**  
 CLIENT NAME: **Port of Everett**  
 DATE STARTED: **September 25, 2000**  
 DATE COMPLETED: **September 25, 2000**  
 DRILLING CONTRACTOR: **Cascade Drilling**  
 DRILLER:  
 DRILLING METHOD: **Geoprobe**  
 SAMPLING METHOD: **Geoprobe**

WATER LEVEL: **▼ 4.00 ft**

ELEVATION: **18 ft**  
 TOTAL DEPTH: **12.00 ft**  
 WEATHER:  
 FIELD ENGINEER: **T. Parkington**  
 CHECKED BY: **M. McCabe**

SAMPLER DRIVEN (in)	FINES CONTENT (%)	DRY DENSITY (pcf)	MOISTURE CONTENT (%)	BLOWS PER FOOT	SAMPLE TYPE	ELEVATION (ft.)	DEPTH (ft.)	USCS	GRAPHIC SYMBOL	DESCRIPTION	REMARKS
						18	0			Asphaltic Concrete.	
								GP		Gravel subgrade	
								PT		Dark brown silty peat	PID = 3 ppm
						13	5				PID = 24 ppm
								SM		Black silty sand with some woody peat	PID = 2 ppm
								SM		Brown sand with some silt. h.c. odor	
						8	10			Brown gray sand, wet.	PID = 0 ppm No odor
										Boring completed at 12 feet. Backfilled with Bentonite. Ground water at 4 feet bgs.	

**SAMPLE TYPE KEY:**

- Relatively undisturbed sample
- Disturbed sample
- Sample attempt with no recovery
- SPT split spoon sample
- Bag Sample
- Pocket Penetrometer
- Vane Shear (psf)

LOB3 K:\16304333--1\GEOPROBE.GPJ\_URSSEA1.GLB\_URSSEA1.GDT\_11/3/00\_Seattle, WA 98121

NOTES:



# LOG OF BORING NO. UG-2

PROJECT: **California Street Overcrossing**  
 PROJECT NO: **04333-041-189**  
 PROJECT LOCATION: **Everett, WA**  
 CLIENT NAME: **Port of Everett**  
 DATE STARTED: **September 25, 2000**  
 DATE COMPLETED: **September 25, 2000**  
 DRILLING CONTRACTOR: **Cascade Drilling**  
 DRILLER:  
 DRILLING METHOD: **Geoprobe**  
 SAMPLING METHOD: **Geoprobe**

WATER LEVEL: **▼ 3.00 ft**

ELEVATION: **16 ft**  
 TOTAL DEPTH: **17.00 ft**

WEATHER:  
 FIELD ENGINEER: **T. Parkington**  
 CHECKED BY: **M. McCabe**

SAMPLER DRIVEN (in)	FINES CONTENT (%)	DRY DENSITY (pcf)	MOISTURE CONTENT (%)	BLOWS PER FOOT	SAMPLE TYPE	ELEVATION (ft.)	DEPTH (ft.)	USCS GRAPHIC SYMBOL	DESCRIPTION	REMARKS
						16	0	■	Asphaltic Concrete.	
								■	Black organic silt	
					X		3	▼	Black silty sand. Strong odor.	PID = 200 ppm
					X	11	5	■	Black woody peat	Very oily. PID = 200 ppm GW sample taken PID = 300 ppm
					X			■		PID = 12 ppm
					X	6	10	■		
					X			■		
					X	1	15	■	Brown silty sand.	PID = 0 ppm
									Boring completed at 17 feet. Backfilled with bentonite. Ground water at 3 feet	

**SAMPLE TYPE KEY:**

- Relatively undisturbed sample
- Disturbed sample
- Sample attempt with no recovery
- SPT split spoon sample
- B Bag Sample
- ↓ Pocket Penetrometer
- V Vane Shear (psf)

LOB3 K:116304333--1GEOPROBE.GPJ\_URSSEA1.GLB\_URSSEA1.GDT 11/3/00 Seattle, WA 98121

NOTES:



**LOG OF BORING UG-2**

FIGURE G 2

# LOG OF BORING NO. UG-3

**PROJECT:** California Street Overcrossing  
**PROJECT NO:** 04333-041-189  
**PROJECT LOCATION:** Everett, WA  
**CLIENT NAME:** Port of Everett  
**DATE STARTED:** September 25, 2000  
**DATE COMPLETED:** September 25, 2000  
**DRILLING CONTRACTOR:** Cascade Drilling  
**DRILLER:**  
**DRILLING METHOD:** Geoprobe  
**SAMPLING METHOD:** Geoprobe

**WATER LEVEL:**  $\nabla$  5.00 ft  
  
**ELEVATION:** 18 ft  
**TOTAL DEPTH:** 14.50 ft  
**WEATHER:**  
**FIELD ENGINEER:** T. Parkinson  
**CHECKED BY:** M. McCabe

SAMPLER DRIVEN (in)	FINES CONTENT (%)	DRY DENSITY (pcf)	MOISTURE CONTENT (%)	BLOWS PER FOOT	SAMPLE TYPE	ELEVATION (ft.)	DEPTH (ft.)	USCS	GRAPHIC SYMBOL	DESCRIPTION	REMARKS
						18	0			Asphaltic Concrete.	
										Gravel subgrade	
					X					Gray brown silty sand	PID = 0 ppm
					X	13				Red-tan silty sand	PID = 0 ppm
					X					Brown silty sand / sandy silt with lenses of woody peat.	PID = 1 ppm
					X	8	10				
					O						No evidence of hydrocarbons in water on rods
										Boring completed at 14.5 feet. Backfilled with bentonite. Groundwater at 5 feet bgs.	

**SAMPLE TYPE KEY:**

- Relatively undisturbed sample
- Disturbed sample
- Sample attempt with no recovery
- SPT split spoon sample
- Bag Sample
- Pocket Penetrometer
- Vane Shear (psf)

LOB3 K1163104333--1GEOPROBE.GPJ\_URSSEA1.GLB\_URSSEA1.GDT 11/23/00 Seattle, WA 98121

NOTES:



**LOG OF BORING UG-3**

FIGURE G 3

# LOG OF BORING NO. UG-4

PROJECT: **California Street Overcrossing**  
 PROJECT NO: **04333-041-189**  
 PROJECT LOCATION: **Everett, WA**  
 CLIENT NAME: **Port of Everett**  
 DATE STARTED: **September 25, 2000**  
 DATE COMPLETED: **September 25, 2000**  
 DRILLING CONTRACTOR: **Cascade Drilling**  
 DRILLER:  
 DRILLING METHOD: **Geoprobe**  
 SAMPLING METHOD: **Geoprobe**

WATER LEVEL: **▼ 4.00 ft**

ELEVATION: **20 ft**  
 TOTAL DEPTH: **14.50 ft**  
 WEATHER:  
 FIELD ENGINEER: **T. Parkington**  
 CHECKED BY: **M. McCabe**

SAMPLER DRIVEN (in)	FINES CONTENT (%)	DRY DENSITY (pcf)	MOISTURE CONTENT (%)	BLOWS PER FOOT	SAMPLE TYPE	ELEVATION (ft.)	DEPTH (ft.)	USCS	GRAPHIC SYMBOL	DESCRIPTION	REMARKS
					X	20	0	GP		Gravel	
					X	17	4	SM		Brown sand with some silt and gravel. No odor	PID = 0 ppm
					X	15	5	ML		Gray silt	PID = 0 ppm
					X	12	8	SM		Brown sand with some silt	PID = 0 ppm
					X	8	12				
					X	4	16				
Boring completed at 14.5 feet. Backfilled with bentonite. Groundwater at 4 feet.											

**SAMPLE TYPE KEY:**

- |  |  |
|--|--|
| <ul style="list-style-type: none"> <li> Relatively undisturbed sample</li> <li> Disturbed sample</li> <li> Sample attempt with no recovery</li> <li> SPT split spoon sample</li> </ul> | <ul style="list-style-type: none"> <li> Bag Sample</li> <li> Pocket Penetrometer</li> <li> Vane Shear (psf)</li> </ul> |
|--|--|

LOB3 K1163104333--1GEOPROBE.GPJ\_URSSEA1.GLB\_URSSEA1.GDT 11/2000 Seattle, WA 98121

NOTES:



# LOG OF BORING NO. UG-5

**PROJECT:** California Street Overcrossing  
**PROJECT NO:** 04333-041-189  
**PROJECT LOCATION:** Everett, WA  
**CLIENT NAME:** Port of Everett  
**DATE STARTED:** September 25, 2000  
**DATE COMPLETED:** September 25, 2000  
**DRILLING CONTRACTOR:** Cascade Drilling  
**DRILLER:**  
**DRILLING METHOD:** Geoprobe  
**SAMPLING METHOD:** Geoprobe

**WATER LEVEL:**  $\nabla$  6.00 ft

**ELEVATION:** 19 ft  
**TOTAL DEPTH:** 12.00 ft  
**WEATHER:**  
**FIELD ENGINEER:** B. Strickler  
**CHECKED BY:** M. McCabe

SAMPLER DRIVEN (in)	FINES CONTENT (%)	DRY DENSITY (pcf)	MOISTURE CONTENT (%)	BLOWS PER FOOT	SAMPLE TYPE	ELEVATION (ft.)	DEPTH (ft.)	USCS	GRAPHIC SYMBOL	DESCRIPTION	REMARKS
						19	0	GP		Gravel	
								SM		Brown silty sand with trace gravel. No odor.	PID = 0 ppm
						14	5	SM		Gray silty sand	PID = 0 ppm
								SM		Dark brown silty sand with trace gravel and wood fragments.	PID = 0 ppm
						9	10				PID = 0 ppm
										End of boring at 12 feet. Backfilled with bentonite. Ground water at 6 feet bgs.	

**SAMPLE TYPE KEY:**

- Relatively undisturbed sample
- Disturbed sample
- Sample attempt with no recovery
- SPT split spoon sample
- Bag Sample
- Pocket Penetrometer
- Vane Shear (psf)

LOB3\_K116304333--1GEOPROBE.GPJ\_URSSEA1.GLB\_URSSEA1.GDT\_11/3/00 Seattle, WA 98121

NOTES:



**LOG OF BORING UG-5**

FIGURE G 5





# LOG OF BORING NO. UG-7

PROJECT: **California Street Overcrossing**  
 PROJECT NO: **04333-041-189**  
 PROJECT LOCATION: **Everett, WA**  
 CLIENT NAME: **Port of Everett**  
 DATE STARTED: **September 26, 2000**  
 DATE COMPLETED: **September 26, 2000**  
 DRILLING CONTRACTOR: **Cascade Drilling**  
 DRILLER:  
 DRILLING METHOD: **Geoprobe**  
 SAMPLING METHOD: **Geoprobe**

WATER LEVEL: **▼ 2.00 ft**  
 ELEVATION: **16 ft**  
 TOTAL DEPTH: **12.00 ft**  
 WEATHER:  
 FIELD ENGINEER: **B. Strickler**  
 CHECKED BY: **M. McCabe**

SAMPLER DRIVEN (in)	FINES CONTENT (%)	DRY DENSITY (pcf)	MOISTURE CONTENT (%)	BLOWS PER FOOT	SAMPLE TYPE	ELEVATION (ft.)	DEPTH (ft.)	USCS	GRAPHIC SYMBOL	DESCRIPTION	REMARKS
						16	0		■	Asphaltic Concrete.	
					⊗		▼	SM	▽	Dark brown to gray silty sand with some gravel	PID = 0 ppm
					⊗	11	5		▽	Some wood fragments	PID = 0 ppm
					⊗	6	10		▽	Dark brown sand with some silt and gravel.	PID = 0 ppm
										End of boring at 12 feet. Backfilled with bentonite. Groundwater at 2 feet bgs.	

**SAMPLE TYPE KEY:**

- Relatively undisturbed sample
- ⊗ Disturbed sample
- Sample attempt with no recovery
- ◐ SPT split spoon sample
- B Bag Sample
- I Pocket Penetrometer
- V Vane Shear (psf)

NOTES:



# LOG OF BORING NO. UG-8

**PROJECT:** California Street Overcrossing  
**PROJECT NO:** 04333-041-189  
**PROJECT LOCATION:** Everett, WA  
**CLIENT NAME:** Port of Everett  
**DATE STARTED:** September 26, 2000  
**DATE COMPLETED:** September 26, 2000  
**DRILLING CONTRACTOR:** Cascade Drilling  
**DRILLER:**  
**DRILLING METHOD:** Geoprobe  
**SAMPLING METHOD:** Geoprobe

**WATER LEVEL:**  $\nabla$  4.00 ft

**ELEVATION:** 17 ft  
**TOTAL DEPTH:** 19.50 ft  
**WEATHER:**  
**FIELD ENGINEER:** B. Strickler  
**CHECKED BY:** M. McCabe

SAMPLER DRIVEN (in)	FINES CONTENT (%)	DRY DENSITY (pcf)	MOISTURE CONTENT (%)	BLOWS PER FOOT	SAMPLE TYPE	ELEVATION (ft.)	DEPTH (ft.)	USCS GRAPHIC SYMBOL	SAMPLE TYPE KEY:		DESCRIPTION	REMARKS
									Relatively undisturbed sample Disturbed sample Sample attempt with no recovery SPT split spoon sample	Bag Sample Pocket Penetrometer Vane Shear (psf)		
						17	0	GP			Gravel	
								SM			Gray silty sand with some gravel	
								SM			Dark brown to black silty sand with some gravel and wood fragmenst. Strong odor. Strong odor	PID = 186 ppm
						12	5	SM			Gray silty sand with some gravel Black silty sand with some wood fragments. Strong odor	PID = 180 ppm
								PT			Black woody peat, strong odor. Color grades to red with no odor.	PID = 105 ppm
						7	10					PID = 5 ppm
												PID = 0 ppm
											Brown sand with some silt and gravel. Faint odor	
						2	15				No odor.	PID = 0 ppm
											End of boring at 19.5 feet. Backfilled with bentonite. Gound water at 4 feet bgs.	

LOB3 K:116304333--1GEOPROBE.GPJ\_URSSEA1.GLB\_URSSEA1.GDT\_11/2/00 Seattle, WA 98121

NOTES:



**LOG OF BORING UG-8**

FIGURE G 8

# LOG OF BORING NO. UG-9

PROJECT: **California Street Overcrossing**  
 PROJECT NO: **04333-041-189**  
 PROJECT LOCATION: **Everett, WA**  
 CLIENT NAME: **Port of Everett**  
 DATE STARTED: **September 26, 2000**  
 DATE COMPLETED: **September 26, 2000**  
 DRILLING CONTRACTOR: **Cascade Drilling**  
 DRILLER:  
 DRILLING METHOD: **Geoprobe**  
 SAMPLING METHOD: **Geoprobe**

WATER LEVEL: **▼4.00 ft**  
 ELEVATION: **18 ft**  
 TOTAL DEPTH: **17.00 ft**  
 WEATHER:  
 FIELD ENGINEER: **B. Strickler**  
 CHECKED BY: **M. McCabe**

SAMPLER DRIVEN (in)	FINES CONTENT (%)	DRY DENSITY (pcf)	MOISTURE CONTENT (%)	BLOWS PER FOOT	SAMPLE TYPE	ELEVATION (ft.)	DEPTH (ft.)	USCS	GRAPHIC SYMBOL	DESCRIPTION	REMARKS
					X	18	0	GP		Gravel	
					X		4	SM		Gray silty sand with some gravel. Strong odor.	PID = 430 ppm
					X	13	5			Strong odor.	PID = 175 ppm
					X		8	PT		Woody peat. Strong odor.	PID = 200 ppm
					X	8	10			Strong odor.	PID = 375 ppm
		827.4			X		15	SP		Brown sand with trace silt and some gravel. Some odor.	PID = 0 ppm
					X	3	15			No odor	PID = 0 ppm
										End of boring at 17 feet. Backfill with bentonite. Groundwater at 4 feet bgs.	

**SAMPLE TYPE KEY:**

- Relatively undisturbed sample
- Disturbed sample
- Sample attempt with no recovery
- SPT split spoon sample
- Bag Sample
- Pocket Penetrometer
- Vane Shear (psf)

NOTES:

LOB3 K:16304333--1GEOPROBE.GPJ\_URSSSE1.GLB\_URSSSE1.GDT\_11/3/00 Seattle, WA 98121



# LOG OF BORING NO. UG-10

PROJECT: **California Street Overcrossing**  
 PROJECT NO: **04333-041-189**  
 PROJECT LOCATION: **Everett, WA**  
 CLIENT NAME: **Port of Everett**  
 DATE STARTED: **September 26, 2000**  
 DATE COMPLETED: **September 26, 2000**  
 DRILLING CONTRACTOR: **Cascade Drilling**  
 DRILLER:  
 DRILLING METHOD: **Geoprobe**  
 SAMPLING METHOD: **Geoprobe**

WATER LEVEL: **▼ 3.00 ft**  
 ELEVATION: **18 ft**  
 TOTAL DEPTH: **12.00 ft**  
 WEATHER:  
 FIELD ENGINEER: **B. Strickler**  
 CHECKED BY: **M. McCabe**

SAMPLER DRIVEN (in)	FINES CONTENT (%)	DRY DENSITY (pcf)	MOISTURE CONTENT (%)	BLOWS PER FOOT	SAMPLE TYPE	ELEVATION (ft.)	DEPTH (ft.)	USCS	GRAPHIC SYMBOL	DESCRIPTION	REMARKS
						18	0	GP	○	Gravel	
						3	3	SP	▼	Brown to dark brown sand with some to trace silt and gravel. No odor.	PID = 0 ppm
						5	5				PID = 0 ppm
						8	8				PID = 0 ppm
						10	10				PID = 0 ppm
										End of boring at 12 feet. Backfilled with Bentonite. Groundwater at 3 feet bgs.	

**SAMPLE TYPE KEY:**

- Relatively undisturbed sample
- Disturbed sample
- Sample attempt with no recovery
- SPT split spoon sample
- Bag Sample
- Pocket Penetrometer
- Vane Shear (psf)

LOB3 K1163104333--1GEOPROBE.GPJ\_URSSEA1.GLB\_URSSEA1.GDT 11/2/00 Seattle, WA 98121

NOTES:



**LOG OF BORING UG-10**

FIGURE G 10

# LOG OF BORING NO. UG-11

**PROJECT:** California Street Overcrossing  
**PROJECT NO:** 04333-041-189  
**PROJECT LOCATION:** Everett, WA  
**CLIENT NAME:** Port of Everett  
**DATE STARTED:** September 26, 2000  
**DATE COMPLETED:** September 26, 2000  
**DRILLING CONTRACTOR:** Cascade Drilling  
**DRILLER:**  
**DRILLING METHOD:** Geoprobe  
**SAMPLING METHOD:** Geoprobe

**WATER LEVEL:** 4.00 ft  
**ELEVATION:** 18 ft  
**TOTAL DEPTH:** 12.00 ft  
**WEATHER:**  
**FIELD ENGINEER:** B. Strickler  
**CHECKED BY:** M. McCabe

SAMPLER DRIVEN (in)	FINES CONTENT (%)	DRY DENSITY (pcf)	MOISTURE CONTENT (%)	BLOWS PER FOOT	SAMPLE TYPE	ELEVATION (ft.)	DEPTH (ft.)	USCS	GRAPHIC SYMBOL	DESCRIPTION	REMARKS
						18	0	GP	○	Gravel.	
								SP	●	Brown to gray sand with some to trace silt and gravel. Faint odor.	PID = 0 ppm
					X	13			▼	No odor	PID = 0 ppm
					X						PID = 0 ppm
					X	8	10				PID = 0 ppm
										End of boring at 12 feet. Backfilled with bentonite. Groundwater at 4 feet bgs.	

**SAMPLE TYPE KEY:**

- Relatively undisturbed sample
- Disturbed sample
- Sample attempt with no recovery
- SPT split spoon sample
- Bag Sample
- Pocket Penetrometer
- Vane Shear (psf)

LOB3 K116304333--1GEOPROBE.GPJ\_URSSEA1.GLB\_URSSEA1.GDT 11/3/00 Seattle, WA 98121

NOTES:



# LOG OF BORING NO. UG-12

PROJECT: **California Street Overcrossing**  
 PROJECT NO: **04333-041-189**  
 PROJECT LOCATION: **Everett, WA**  
 CLIENT NAME: **Port of Everett**  
 DATE STARTED: **September 26, 2000**  
 DATE COMPLETED: **September 26, 2000**  
 DRILLING CONTRACTOR: **Cascade Drilling**  
 DRILLER:  
 DRILLING METHOD: **Geoprobe**  
 SAMPLING METHOD: **Geoprobe**

WATER LEVEL: **▼4.00 ft**  
 ELEVATION: **18 ft**  
 TOTAL DEPTH: **12.00 ft**  
 WEATHER:  
 FIELD ENGINEER: **B. Strickler**  
 CHECKED BY: **M. McCabe**

SAMPLER DRIVEN (in)	FINES CONTENT (%)	DRY DENSITY (pcf)	MOISTURE CONTENT (%)	BLOWS PER FOOT	SAMPLE TYPE	ELEVATION (ft.)	DEPTH (ft.)	USCS	GRAPHIC SYMBOL	DESCRIPTION	REMARKS
						18	0				
					X		▼	SP		Brown sand with trace silt and gravel. No odor.	PID = 0 ppm
					X	13	5			Some wood fragments.	PID = 0 ppm
					X						PID = 0 ppm
					X	8	10				PID = 0 ppm
								PT		Woody peat	
								SP		Brown sand with trace silt and gravel.	
										End of boring at 12 feet. Groundwater at 4 feet bgs. Backfilled with bentonite.	

**SAMPLE TYPE KEY:**

- Relatively undisturbed sample
- Disturbed sample
- Sample attempt with no recovery
- SPT split spoon sample
- Bag Sample
- Pocket Penetrometer
- Vane Shear (psf)

NOTES:



**LOG OF BORING UG-12**

FIGURE G 12

#### Project Information

Project Name:	California Street Overcrossing	Location:	California St and Federal Ave
Project/Task No.:	53-04333041.00 00056	Weather:	sunny, 60F

#### Drilling Information

Date Started:	Thursday, June 21, 2001	Annulus Diameter:	2 inches
Date Completed:	Thursday, June 21, 2001	Hammer Weight and Drop:	NA lbs and NA inches
Drilled By:	Kasey Goble of Cascade Drilling	Sampler Type:	3' stainless steel split spoon
Logged By:	Kate Pineo of URS	Approximate Surface Elevation:	NA feet
Checked By:	Dave Raubvogel of URS	Groundwater Level:	4 below ground surface
Drilling Method:	Direct Push	Total Depth:	13 below ground surface
Drill Rig Type:	Truck-mounted GeoProbe	Backfill Material:	bentonite chips, asphalt patch

#### Well Installation Data

Type of Well Casing:	NA	Top of PVC Elevation:	NA
Screen Perforation:	NA	Type/Thickness of Seals:	NA
Diameter of Well:	NA	Type of Sand Pack:	NA
Screened Interval:	NA		

Depth (feet)	Blows per 6 inches	Penetration/Recovery (inches)	Time	USCS Classification	USCS Graphic	Material Description	Well Completion Diagram	PID Readings (ppm)	Samples	Remarks
0						Asphalt, gravel road base.				
1		36/24		SM		Gray to brown Silt and fine Sand, some very angular fine Gravel, dry.		16.1	JP1/1.5-4.5	Began sampling at 1.5'.
2				SP		Gray medium to coarse sand, mottled, moist.				
3				ML		Gray Silt and Clay, wood debris, moist.				
4		36/27	8:15	SM		Brown fine Sand and Silt, wet.		45	JP1/4.5-7.5	
5				ML		Brown Silt and Clay, wet.				
6										
7										
8		36/36	8:30	SM		Brown Sand and Silt with silty clay interbeds, grading black.		15	JP1/7.5-10	
9										
10		36/12	8:45	SP		Brown medium to coarse Sand, medium soft, mottled, wet.		5		Refusal at 10' bgs. Moved 6.5' west and sampled 10 - 13'.
11										
12										
13						BORING COMPLETED AT 13'				
14										
15										
16										
17										
18										
19										
20										

#### NOTES:

Groundwater level measured down-hole with water level indicator.  
 PID screening on black soil at 10' bgs = 14 ppm.  
 Sampled groundwater JP1/GW at 8:30. Slow recharge, very clear water.  
 Slight organic odor in 10 - 13' sample. Not collected for analysis.



### Project Information

Project Name:	<u>California Street Overcrossing</u>	Location:	<u>California St and Federal Ave</u>
Project/Task No.:	<u>53-04333041.00 00056</u>	Weather:	<u>sunny, 60F</u>

### Drilling Information

Date Started:	<u>Thursday, June 21, 2001</u>	Annulus Diameter:	<u>2</u> inches
Date Completed:	<u>Thursday, June 21, 2001</u>	Hammer Weight and Drop:	<u>NA</u> lbs and <u>NA</u> inches
Drilled By:	<u>Kasey Goble</u> of <u>Cascade Drilling</u>	Sampler Type:	<u>3' stainless steel split spoon</u>
Logged By:	<u>Kate Pineo</u> of <u>URS</u>	Approximate Surface Elevation:	<u>NA</u> feet
Checked By:	<u>Dave Raubvogel</u> of <u>URS</u>	Groundwater Level:	<u>2.3</u> below ground surface
Drilling Method:	<u>Direct Push</u>	Total Depth:	<u>6</u> below ground surface
Drill Rig Type:	<u>Truck-mounted GeoProbe</u>	Backfill Material:	<u>benonite chips</u>

### Well Installation Data

Type of Well Casing:	<u>NA</u>	Top of PVC Elevation:	<u>NA</u>
Screen Perforation:	<u>NA</u>	Type/Thickness of Seals:	<u>NA</u>
Diameter of Well:	<u>NA</u>	Type of Sand Pack:	<u>NA</u>
Screened Interval:	<u>NA</u>		

Depth (feet)	Blows per 6 inches	Penetration/Recovery (inches)	Time	USCS Classification	USCS Graphic	Material Description	Well Completion Diagram	PID Readings (ppm)	Samples	Remarks
0		36/24	9:15	ML		Brown Silt and Clay, some fine Gravel, dry.		0	JP2/0-3	
1				SM		Fine Sand and Silt, some fine Gravel, wet.		0	JP2/3-6	
2										
3		36/24	9:15			Grading brown fine to coarse Sand and fine Gravel, some Silt.				
4						Grading brown-gray fine Sand and Silt, some fine to coarse Gravel.				
5						Black fine Sand, saturated.				
6						BORING COMPLETED AT 6'				
7										
8										
9										

### NOTES:

Groundwater level measured down-hole with water level indicator.

#### Project Information

Project Name:	<u>California Street Overcrossing</u>	Location:	<u>California St and Federal Ave</u>
Project/Task No.:	<u>53-04333041.00 00056</u>	Weather:	<u>sunny, 60F</u>

#### Drilling Information

Date Started:	<u>Thursday, June 21, 2001</u>	Annulus Diameter:	<u>2</u> inches
Date Completed:	<u>Thursday, June 21, 2001</u>	Hammer Weight and Drop:	<u>NA</u> lbs and <u>NA</u> inches
Drilled By:	<u>Kasey Goble</u> of <u>Cascade Drilling</u>	Sampler Type:	<u>3' stainless steel split spoon</u>
Logged By:	<u>Kate Pineo</u> of <u>URS</u>	Approximate Surface Elevation:	<u>NA</u> feet
Checked By:	<u>Dave Raubvogel</u> of <u>URS</u>	Groundwater Level:	<u>2.5</u> below ground surface
Drilling Method:	<u>Direct Push</u>	Total Depth:	<u>6</u> below ground surface
Drill Rig Type:	<u>Truck-mounted GeoProbe</u>	Backfill Material:	<u>bentonite chips</u>

#### Well Installation Data

Type of Well Casing:	<u>NA</u>	Top of PVC Elevation:	<u>NA</u>
Screen Perforation:	<u>NA</u>	Type/Thickness of Seals:	<u>NA</u>
Diameter of Well:	<u>NA</u>	Type of Sand Pack:	<u>NA</u>
Screened Interval:	<u>NA</u>		

Depth (feet)	Blows per 6 inches	Penetration/Recovery (inches)	Time	USCS Classification	USCS Graphic	Material Description	Well Completion Diagram	PID Readings (ppm)	Samples	Remarks
0		36/30	10:00	GP		Brown fine to medium Sand and fine Gravel, dry.		8.5	JP3/0-3	
1				ML		Brown-gray Silt and Clay, some fine Gravel, damp.				
2										
3		36/36	10:00	SM		Brown fine Sand and Silt, wet.		6	JP3/3-6	
4										
5										
6						BORING COMPLETED AT 6'.				
7										
8										
9										

#### NOTES:

Groundwater level measured down-hole with water level indicator.

### Project Information

Project Name:	California Street Overcrossing	Location:	California St and Federal Ave
Project/Task No.:	53-04333041.00 00056	Weather:	sunny, 60F

### Drilling Information

Date Started:	Thursday, June 21, 2001	Annulus Diameter:	2 inches
Date Completed:	Thursday, June 21, 2001	Hammer Weight and Drop:	NA lbs and NA inches
Drilled By:	Kasey Goble of Cascade Drilling	Sampler Type:	3' stainless steel split spoon
Logged By:	Kate Pineo of URS	Approximate Surface Elevation:	NA feet
Checked By:	Dave Raubvogel of URS	Groundwater Level:	2 below ground surface
Drilling Method:	Direct Push	Total Depth:	10 below ground surface
Drill Rig Type:	Truck-mounted GeoProbe	Backfill Material:	bentonite chips

### Well Installation Data

Type of Well Casing:	NA	Top of PVC Elevation:	NA
Screen Perforation:	NA	Type/Thickness of Seals:	NA
Diameter of Well:	NA	Type of Sand Pack:	NA
Screened Interval:	NA		

Depth (feet)	Blows per 6 inches	Penetration/Recovery (inches)	Time	USCS Classification	USCS Graphic	Material Description	Well Completion Diagram	PID Readings (ppm)	Samples	Remarks
0		36/24	10:30	GP		Brown-gray fine Sand and Gravel, dry		280 - 300	JP4/0-3	Odor.
1				SM		Gray fine Sand and Silt, some fine Gravel, dark gray ash/sinder layer, dry.				
2						Grading brown fine Sand and Silt, little coarse Gravel.				
3		36/12	10:45	SP		Brown fine to coarse SAND, little coarse Gravel, wet.		270	JP4/3-6	Odor.
4										
5										
6						No sample collected.				
7										
8		24/7	10:50	SM		Gray medium Sand and Silt, wet. Red-brown wood debris noted.		5.3	JP4/8-10	
9										

BORING COMPLETED AT 10'.

### NOTES:

Groundwater level measured down-hole with water level indicator.  
Groundwater sample JP4/GW collected at 10:50.

### Project Information

Project Name:	<u>California Street Overcrossing</u>	Location:	<u>California St and Federal Ave</u>
Project/Task No.:	<u>53-04333041.00 00056</u>	Weather:	<u>sunny, 60F</u>

### Drilling Information

Date Started:	<u>Thursday, June 21, 2001</u>	Annulus Diameter:	<u>2</u> inches
Date Completed:	<u>Thursday, June 21, 2001</u>	Hammer Weight and Drop:	<u>NA</u> lbs and <u>NA</u> inches
Drilled By:	<u>Kasey Goble</u> of <u>Cascade Drilling</u>	Sampler Type:	<u>3' stainless steel split spoon</u>
Logged By:	<u>Kate Pineo</u> of <u>URS</u>	Approximate Surface Elevation:	<u>NA</u> feet
Checked By:	<u>Dave Raubvogel</u> of <u>URS</u>	Groundwater Level:	<u>2</u> below ground surface
Drilling Method:	<u>Direct Push</u>	Total Depth:	<u>6</u> below ground surface
Drill Rig Type:	<u>Truck-mounted GeoProbe</u>	Backfill Material:	<u>bentonite chips</u>

### Well Installation Data

Type of Well Casing:	<u>NA</u>	Top of PVC Elevation:	<u>NA</u>
Screen Perforation:	<u>NA</u>	Type/Thickness of Seals:	<u>NA</u>
Diameter of Well:	<u>NA</u>	Type of Sand Pack:	<u>NA</u>
Screened Interval:	<u>NA</u>		

Depth (feet)	Blows per 6 inches	Penetration/Recovery (inches)	Time	USCS Classification	USCS Graphic	Material Description	Well Completion Diagram	PTD Readings (ppm)	Samples	Remarks
0		36/36	11:05	SM		Light gray fine Sand and Silt, some coarse Gravel, dry.		4.3	JP5/0-3	
1				ML		Dark gray SILT and coarse Gravel				
		36/22	11:10	SM		Brown dense fine Sand and Silt, wet, grading gray.		1.5		
2										
3						Grading brown.		5.3	JP5/3-6	
4										
5										
				SP		Black fine to medium Sand and Gravel.				
6						BORING COMPLETED AT 6'.				
7										
8										
9										

### NOTES:

Groundwater level measured down-hole with water level indicator.

#### Project Information

Project Name:	<u>California Street Overcrossing</u>	Location:	<u>California St and Federal Ave</u>
Project/Task No.:	<u>53-04333041.00 00056</u>	Weather:	<u>sunny, 60F</u>

#### Drilling Information

Date Started:	<u>Thursday, June 21, 2001</u>	Annulus Diameter:	<u>2</u> inches
Date Completed:	<u>Thursday, June 21, 2001</u>	Hammer Weight and Drop:	<u>NA</u> lbs and <u>NA</u> inches
Drilled By:	<u>Kasey Goble</u> of <u>Cascade Drilling</u>	Sampler Type:	<u>3' stainless steel split spoon</u>
Logged By:	<u>Kate Pineo</u> of <u>URS</u>	Approximate Surface Elevation:	<u>NA</u> feet
Checked By:	<u>Dave Raubvogel</u> of <u>URS</u>	Groundwater Level:	<u>2</u> below ground surface
Drilling Method:	<u>Direct Push</u>	Total Depth:	<u>9</u> below ground surface
Drill Rig Type:	<u>Truck-mounted GeoProbe</u>	Backfill Material:	<u>bentonite chips</u>

#### Well Installation Data

Type of Well Casing:	<u>NA</u>	Top of PVC Elevation:	<u>NA</u>
Screen Perforation:	<u>NA</u>	Type/Thickness of Seals:	<u>NA</u>
Diameter of Well:	<u>NA</u>	Type of Sand Pack:	<u>NA</u>
Screened Interval:	<u>NA</u>		

Depth (feet)	Blows per 6 inches	Penetration/ Recovery (inches)	Time	USCS Classification	USCS Graphic	Material Description	Well Completion Diagram	PID Readings (ppm)	Samples	Remarks
0		36/24	11:50	SM		Gray-brown fine Sand and Silt, some coarse Gravel, mottled, dry.		4.3	JP5/0-3	
1										
2										
3		36/6	11:50			Grading wet.		14		Poor recovery.
4										
5										
6		36/18	11:50			Grading peat noted.		1.5	JP5/6-9	
7										
8										
9						BORING COMPLETED AT 9'.				

#### NOTES:

Groundwater level measured down-hole with water level indicator.

**Project Information**

Project Name:	<u>California Street Overcrossing</u>	Location:	<u>California St and Federal Ave</u>
Project/Task No.:	<u>53-04333041.00 00056</u>	Weather:	<u>sunny, 60F</u>

**Drilling Information**

Date Started:	<u>Thursday, June 21, 2001</u>	Annulus Diameter:	<u>2</u> inches
Date Completed:	<u>Thursday, June 21, 2001</u>	Hammer Weight and Drop:	<u>NA</u> lbs and <u>NA</u> inches
Drilled By:	<u>Kasey Goble</u> of <u>Cascade Drilling</u>	Sampler Type:	<u>3' stainless steel split spoon</u>
Logged By:	<u>Kate Pineo</u> of <u>URS</u>	Approximate Surface Elevation:	<u>NA</u> feet
Checked By:	<u>Dave Raubvogel</u> of <u>URS</u>	Groundwater Level:	<u>2</u> below ground surface
Drilling Method:	<u>Direct Push</u>	Total Depth:	<u>9</u> below ground surface
Drill Rig Type:	<u>Truck-mounted GeoProbe</u>	Backfill Material:	<u> bentonite chips</u>

**Well Installation Data**

Type of Well Casing:	<u>NA</u>	Top of PVC Elevation:	<u>NA</u>
Screen Perforation:	<u>NA</u>	Type/Thickness of Seals:	<u>NA</u>
Diameter of Well:	<u>NA</u>	Type of Sand Pack:	<u>NA</u>
Screened Interval:	<u>NA</u>		

Depth (feet)	Blows per 6 inches	Penetration/Recovery (inches)	Time	USCS Classification	USCS Graphic	Material Description	Well Completion Diagram	PID Readings (ppm)	Samples	Remarks
0		36/30		SM		Light brown fine Sand and Silt, some fine Gravel, dry.				Odor.
1						Grading dark gray.		75	JP7/1-2	
2				SP		Brown fine to medium Sand, little coarse Gravel, wet.		20	JP7/2-3	
3		36/0								No recovery.
4										
5										
6		36/24	12:20			Grading brown fine to medium Sand.		9	JP7/6-9	
7										
8										
9						BORING COMPLETED AT 9'				

**NOTES:**

Groundwater level measured down-hole with water level indicator.

Groundwater sample JP7/GW collected at 12:20.



Project No.: 31174 Boring: MW20 Plate: 1 OF 1  
 Site: Former Mobil Oil Terminal 46-108 Date: 07/03/02  
 Drill Contractor: Cascade Drilling, Inc. of Woodinville, WA

Sample Method: None Geologist: Antonio Luna  
 Drill Rig: CME-55 Bore Hole Diameter: 8" Signature: \_\_\_\_\_  
 Location: Southwest corner of property Registration: \_\_\_\_\_  
in gravel next to Federal Avenue. Logged by: Antonio Luna

DEPTH (ft)	BLOW COUNTS	PID/OVM (ppm)	SAMPLE	COLUMN	USCS	GEOLOGIC DESCRIPTION	WELL DESIGN
5						Removed steel well and point, backfilled with bentonite, capped with 1 foot of cement	
						Total depth, 5 feet below ground surface	

Casing Diameter: N/A, Slot Size: N/A, Sand Size: N/A, Grout: N/A



Project No.: 31174 Boring: MW21 Plate: 1 OF 1  
 Site: Former Mobil Oil Terminal 46-108 Date: 07/03/02  
 Drill Contractor: Cascade Drilling, Inc. of Woodinville, WA

Sample Method: None Geologist: Antonio Luna  
 Drill Rig: CME-55 Bore Hole Diameter: 10" Signature: \_\_\_\_\_  
 Location: Southwest corner of property Registration: \_\_\_\_\_  
in gravel next to Federal Avenue. Logged by: Antonio Luna

DEPTH (ft)	BLOW COUNTS	PTD/OVM (ppm)	SAMPLE	COLUMN	USCS	GEOLOGIC DESCRIPTION	WELL DESIGN
5						Removed schedule 40 PVC well casing, overdrilled to remove seal and sand pack, backfilled with bentonite, capped with 1 foot of cement	
						Total depth, 6 feet below ground surface	

Casing Diameter: N/A, Slot Size: N/A, Sand Size: N/A, Grout: N/A





Project No.: 31174 Boring: Unknown Plate: 1 OF 1  
 Site: Former Mobil Oil Terminal 46-108 Date: 07/03/02  
 Drill Contractor: Cascade Drilling, Inc. of Woodinville, WA

Sample Method: None Geologist: Antonio Luna  
 Drill Rig: CME-55 Bore Hole Diameter: 10" Signature: \_\_\_\_\_  
 Location: Southwest corner of property Registration: \_\_\_\_\_  
in gravel next to Federal Avenue. Logged by: Antonio Luna

DEPTH (ft)	BLOW COUNTS	PD/OVM (ppm)	SAMPLE	COLUMN	USCS	GEOLOGIC DESCRIPTION	WELL DESIGN
5						Well overdrilled to remove well casing, seal, and sand pack, backfilled with bentonite, capped with 1 foot of cement	
						Total depth, 6 feet below ground surface	

Casing Diameter: N/A, Slot Size: N/A, Sand Size: N/A, Grout: N/A

DEPTH (ft bgs)	GRAPHIC LOG	USCS SYMBOL	SOIL DESCRIPTION	SAMPLE	BLOW COUNT SPT N VALUE	VOLATILE READING (ppm)	GROUNDWATER	FIELD AND LABORATORY TESTING	WELL SCHEMATIC
0			Surface: 0.2 feet of asphalt over 1.6 feet of gray fine to medium angular moist, (crushed rock base course) A vac-truck was utilized from 0 to 5 feet below the ground surface to ensure utilities were cleared.						Flush mount in cement seal  Hydrated bentonite chip seal
5		SP SM	Medium dense, moist, brown, fine to coarse SAND with some silt and trace fine gravel Moist to wet, wood; possibly a large block		22	0.0			2-inch PVC casing in 2/12 silica sand filter pack 2-inch PVC 10 slot screen in 2/12 silica sand filter pack
		SP	Loose, wet, brown, fine to medium SAND with trace silt and petroleum odor  Becomes saturated and gray at 8.3 feet Water appeared viscous and sediments appeared to have a metallic luster from 8.3 to 9 feet Becomes medium dense at 9.5 feet		6	0.0	▼	A1_S-1_020408 Sheen Test None Observed A1_S-2_020408	
10			Becomes gray and brown, with some fine gravel and trace silt and no odor observed at 10.4 feet Cobbles in sampler shoe		21	0.0			
		GP-GM SP	Medium dense, saturated, dark gray, fine GRAVEL with some fine to medium sand and silt, light to medium sheen Medium dense, saturated, gray fine to medium SAND with trace silt and fine gravel and occasional organics (wood splinters) Approximatley 0.01 foot thick layers of wood splinters at 13, 14, and 15 feet Becomes loose, with petroleum odor and no visible gravel at 14.5 feet		16	0.0		Sheen Test Light Observed	
15			Becomes loose, with petroleum odor and no visible gravel at 14.5 feet		14	0.0			2/12 silica sand Bentonite chips
			Approximatley 0.1 foot thick layer of stiff, moist, brown, SILT with numerous organics / organic SILT (plant fragments, wood fibers, roots) at 18 feet		14	0.0		Sheen Test Light Observed	
20					24	0.0		Sheen Test None Observed	
		ML	Very stiff, moist, brown, SILT with trace fine to coarse sand and numerous organics / organic SILT with trace fine to coarse sand		20	0.0			
25		SP	Becomes with occasional organics (roots) at 25 feet Medium dense, saturated, gray, fine to medium SAND with trace silt		17	0.0			
30			Exploration terminated at 26.5 feet below the existing ground surface.						

BORING METHOD: HSA

ELEVATION REFERENCE: NA

BOREHOLE DIAMETER: 8 (in)

GROUND SURFACE ELEVATION: NA

DRILL RIG: CME

CASING ELEVATION: NA

CONTRACTOR: Cascade Drilling, Inc./Scott

START CARD/TAG ID: /BAB238

LOGGED BY: LME

DRILLING DATES: 02/04/2008 - 02/04/2008

REMARKS:

ENVR+WELL-BORING FEDERALAVENUE.GPJ AMEC PORTLAND.GDT 3/17/08

**ExxonMobil / American Distributing Company**

**7-915-15716-B**

AMEC Earth and Environmental, Inc.  
11335 NE 122nd Way, Suite 100  
Kirkland, Washington  
USA 98034  
Tel (425) 820-4669  
Fax (425) 821-3914



**LOG OF BORING  
MWA1**

PAGE 1 OF 1

DEPTH (ft bgs)	GRAPHIC LOG	USCS SYMBOL	SOIL DESCRIPTION	SAMPLE	BLOW COUNT SPT N VALUE	VOLATILE READING (ppm)	GROUNDWATER	FIELD AND LABORATORY TESTING	WELL SCHEMATIC
0			Surface: moist, dark gray, angular fine to medium gravel (crushed rock) A vac-truck was utilized from 0 to 5 feet below the ground surface to ensure utilities were cleared.  Approximatley 2 feet of wood with creosote odor (appeared to be blocks of wood treated with creosote)						Flush mount in cement seal  Hydrated bentonite chip seal
5	SP	SP	Very loose, moist, black, fine to medium SAND with some silt and numerous organics (wood splinters)		5	0.0	▼	A2_S-1_020408 Sheen Test Light	2-inch PVC casing in 2/12 silica sand filter pack 2-inch PVC 10 slot screen in 2/12 silica sand filter pack
	SP	SP	Very loose, moist, brown, fine to medium SAND with trace silt					Observed A2_S-2_020408	
	ML	ML	Stiff, wet to saturated, blue-gray, sandy SILT with slight petroleum odor and light sheen						
	OL/ML	OL/ML	Stiff, moist, dark brown to black, organic SILT / SILT with numerous organics (roots, plant fragments) and petroleum odor		11	0.0	▼		
	SM	SM	Loose, wet to saturated, silty, fine to medium SAND with trace fine gravel and petroleum odor and light sheen						
	ML	ML	Stiff, moist, brown, SILT with some clay and numerous organics (roots)		25	0.0		Sheen Test None Observed	
10	SP	SP	Loose, moist to wet, gray, fine to medium SAND with trace silt and scattered organics (roots)						
	SP	SP	Medium dense, saturated, gray, fine to medium SAND with trace silt		17	0.0			
15			Becomes with occasional organics (roots, plant fragments) at 15 feet  Tip of sampler shoe contained wet, brown, organic SILT / SILT with numerous organics (roots, plant fragments)		11	0.0		Sheen Test None Observed	2/12 silica sand Bentonite chips
					14	0.0			
20					16	0.0		Sheen Test None Observed	
	OL/ML	OL/ML	Stiff, moist, brown, organic stratified SILT with some clay and trace fine to medium sand / stratified SILT with some clay and trace fine to medium sand and numerous organics (roots, plant fragments)						
	SP	SP	Medium dense, saturated, gray, fine to medium SAND with trace silt and occasional organics (roots, plant fragments) Becomes no visible organics at 22 feet		25	0.0			
25					25	0.0		Sheen Test None Observed	
30			Exploration terminated at 26.5 feet below the existing ground surface.						

BORING METHOD: HSA

ELEVATION REFERENCE: NA

BOREHOLE DIAMETER: 8 (in)

GROUND SURFACE ELEVATION: NA

DRILL RIG: CME

CASING ELEVATION: NA

CONTRACTOR: Cascade Drilling, Inc./Scott

START CARD/TAG ID: /BAB237

LOGGED BY: LME

DRILLING DATES: 02/04/2008 - 02/04/2008

REMARKS:

ENVR+WELL-BORING FEDERAL AVENUE GPJ AMEC PORTLAND.GDT 3/17/08

ExxonMobil / American Distributing Company

7-915-15716-B

AMEC Earth and Environmental, Inc.  
11335 NE 122nd Way, Suite 100  
Kirkland, Washington  
USA 98034  
Tel (425) 820-4669  
Fax (425) 821-3914



LOG OF BORING  
MWA2

PAGE 1 OF 1

## **APPENDIX D**

PEG Report (Kimberly-Clark Investigations)



Texaco Refining  
and Marketing Inc

3400 188th Street SW  
Suite 630  
Lynnwood WA 98037

RECEIVED

JUN 02 1998

DEPT. OF ECOLOGY

April 20, 1998

Subsurface Investigation Results  
Port of Everett - Former Bulk Facilities  
2600 Federal Avenue, Everett, Washington

*Received by  
Mobil  
6-11-98*

Mr. Norm Peck  
Washington Department of Ecology Northwest Region  
Toxic Cleanup Program  
Mail Stop NB-81  
3190 - 160th Avenue SE  
Bellevue, Washington 98008-5452

Dear Mr. Peck:

Enclosed is a copy of a Environmental Investigation Report for the above-referenced location. The report was prepared by Pacific Environmental Group (PEG) on behalf of Chevron Products Company, Texaco Refining and Marketing, Kimberly-Clark, and Burlington Northern Railroad. The work was conducted in response to Ecology's concern that petroleum bulk distribution facilities formerly located at the site had contributed to the free phase hydrocarbons (free product) identified in a City of Everett Combined Sewer Outfall (CSO Line) located between the subject site and the Mobil/American Distributing facilities to the south.

During June and July 1996, approximately 23,000 gallons of free product (identified as fuel oil) were recovered by others during excavation of the CSO Line. Extensive free product contamination had previously been identified at the Mobil/American Distributing facility. Mobil subsequently conducted a historical investigation of potential off-site sources of petroleum hydrocarbons, and former Standard Oil and Tidewater Oil bulk distribution facilities, located north of the CSO line were identified. Ecology identified Potentially Liable Parties (PLPs) associated with the former facilities and proposed an Agreed Order requiring an investigation to determine whether impacts from the former bulk facilities were contributing to the CSO Line problem.

Four of the PLPs, Chevron, Texaco, Kimberly-Clark, and Burlington Northern/Santa Fe Railroad, decided to conduct an investigation of the former terminals as an independent action in order to expedite the process. The investigation consisted of advancing 15 soil probes and collecting grab samples of groundwater, and installing and sampling two permanent groundwater monitoring wells. The results of the investigation are presented in the enclosed report.

No free product was observed during this investigation. In fact, the only significant dissolved hydrocarbon concentrations identified were in the two probes located adjacent to the CSO Line. Based on the results of this investigation, we believe that it is impossible to conclude that the free product found in the CSO Line is the result of operations at the former Chevron and Tidewater properties, now owned by Kimberley Clark.

Mr. Norm Peck  
April 20, 1998  
Page 2

Additionally, fuel fingerprinting analysis, conducted during the CSO Line repairs, showed a strong correlation between the fuel oil from the CSO Line and the free product recovered from wells at the Mobil/American Distributing site. Based on these results, we believe that there is no reason to maintain any link between the former bulk plants and the Mobil/American Distributing/CSO problem. Further, we see no reason to conduct additional investigation. Please feel free to contact me at (206) 774-6090 extension 227 if you have any questions regarding this report.

Sincerely,

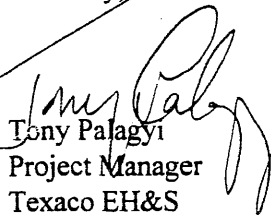

Tony Palagyi  
Project Manager  
Texaco EH&S

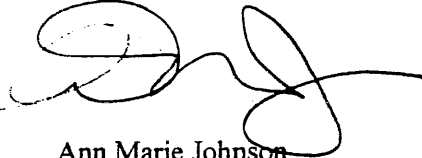

Ann Marie Johnson  
Project Manager  
Chevron Products Company

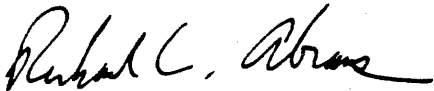

Richard C. Abrams  
Environmental Manager  
Kimberly Clark

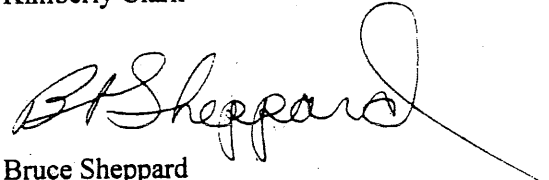

Bruce Sheppard  
Manager Env. Remediation  
Burlington Northern/Santa Fe

RECEIVED  
JUN 02 1998  
DEPT. OF ECOLOGY

— Soil Borings were very shallow perhaps too shallow  
Considering fill history  
— Well screening size may have been too tight to allow viscous fluids to collect.  
— may not be acceptable to WDE, Norm Peck.

## Environmental Investigation Report

Former Bulk Fuel Facilities  
2600 Federal Avenue  
Everett, Washington

Prepared for

Chevron Products Company, Texaco Refining and Marketing,  
Kimberly-Clark, and BNSF

April 14, 1998

Prepared by

Pacific Environmental Group, Inc.  
4020 - 148th Avenue NE, Suite B  
Redmond, Washington 98052

Project 520-165.1A

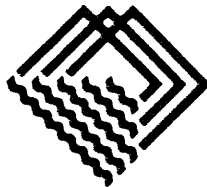

PACIFIC  
ENVIRONMENTAL  
GROUP, INC.

## CONTENTS

---

<b>EXECUTIVE SUMMARY</b>	<b>i</b>
<b>1.0 INTRODUCTION</b>	<b>1</b>
1.1 Scope of Work	1
1.2 Site Description	2
1.3 Previous Investigations	2
<b>2.0 INVESTIGATIVE PROCEDURES</b>	<b>3</b>
2.1 Soil Probe Installation	3
2.1.1 Soil and Groundwater Sampling	3
2.2 Soil Borings and Monitoring Well Installation	4
2.2.1 Soil Sampling	4
2.2.2 Well Casing Installation	4
2.2.3 Well Development and Groundwater Sampling	5
2.3 Analytical Program	6
<b>3.0 FINDINGS</b>	<b>7</b>
3.1 Subsurface Conditions	7
3.2 Sample Analytical Results	7
3.2.1 Soil	7
3.2.2 Groundwater	7
<b>4.0 CONCLUSIONS</b>	<b>9</b>
<b>5.0 SIGNATURES OF ENVIRONMENTAL PROFESSIONALS</b>	<b>10</b>



## **TABLES, FIGURES, AND APPENDICES**

---

### **Tables**

Table 1	Soil Analytical Results
Table 2	Groundwater Analytical Results

### **Figures**

Figure 1	Site Location Map
Figure 2	Site Map - Exploration Locations
Figure 3	Site Map - Groundwater Sample Concentrations

**Appendix A - Investigative Procedures/Field Data Sheets**

**Appendix B - Boring Logs**

**Appendix C - Laboratory Analytical Methods and Results  
Chain of Custody Documentation**

## EXECUTIVE SUMMARY

---

An environmental assessment of soil and groundwater conditions was performed at 2600 Federal Avenue in Everett, Washington. Pacific Environmental Group, Inc. (PEG) conducted this assessment on behalf of Chevron, Texaco, Kimberly-Clark, and BNSF. The scope of work for this environmental assessment was presented in a sampling and analysis workplan dated August 20, 1997, and was performed between November 17, 1997 and January 19, 1998. This workplan was developed in response to the Washington Department of Ecology's decision to name Chevron, Texaco, Kimberly-Clark, and BNSF as Potentially Liable Persons (PLPs), in regard to petroleum contamination found adjacent to the City of Everett Combined Sewer Outfall (CSO) line, which resulted in an oil release into Port Gardner Bay in 1995.

The project consisted of the following tasks:

- Install fifteen exploratory soil probes (Probe 1 through Probe 15).
- Install two soil borings and convert them to groundwater monitoring wells (KC-1 and KC-2).
- Collect soil and groundwater samples from the borings and probes.

Measurable thicknesses of separate-phase hydrocarbons were not identified in any of the soil probes or monitoring wells installed during this investigation. The analytical results from the soil probes and groundwater monitoring wells indicate that the highest concentrations of hydrocarbons in soil and groundwater are limited to the area immediately adjacent to the CSO line. There is no evidence from this investigation that the former facilities on the 2600 Federal Avenue property contributed to the separate-phase hydrocarbons encountered during repair of the CSO line in 1996.

## 1.0 INTRODUCTION

---

### 1.1 Scope of Work

This investigation was performed between November 17, 1997 and January 19, 1998. The purpose of this investigation was to evaluate soil and groundwater quality in the vicinity of several former petroleum bulk plants adjacent to Port Gardner Bay in Everett, Washington (Figure 1). The goal of this investigation was to show whether evidence exists that would suggest the former facilities contributed to the separate-phase hydrocarbons documented at the CSO line. The scope of work consisted of the following tasks:

- Prepare a site safety plan for the project in accordance with WISHA and OSHA regulations.
- Install fifteen exploratory soil probes (Probe-1 through Probe-15) using a direct push probe sampling rig, and a hand auger.
- Install two soil borings using a hollow-stem auger drilling rig. Convert the borings to groundwater monitoring wells (KC-1 and KC-2) using 2-inch diameter Schedule 40 PVC well casing with 0.020-inch slotted screen.
- Collect soil samples from the borings and probes for soil characterization and possible laboratory analysis.
- Conduct field screening of soil samples using a photoionization detector and an oil sheen test.
- Develop and sample the two newly installed monitoring wells.
- Submit soil and groundwater samples and appropriate documentation to a Washington State accredited laboratory for analyses.
- Prepare this report.

Each of these tasks is described in detail in Section 2.0, and the findings and conclusions are presented in Sections 3.0 and 4.0.

## 1.2 Site Description

The project site is located on the Port Gardner Bay waterfront near Federal Avenue and the foot of Everett Avenue in Everett, Snohomish County, Washington. The property being investigated is currently the site of a pulp and paper mill owned by Kimberly-Clark, a railroad right-of-way owned by BNSF, and part of the Port of Everett that includes a log yard and a towing business (Dunlap Towing), hereafter referred to as "the Site". The Site was the former location of petroleum bulk plants operated by Standard Oil of California (Chevron) and Associated Oil Company (Texaco). Aboveground petroleum storage tanks were also operated on the Site until recently by Kimberly-Clark. Figure 2 shows the locations of former facilities in relation to the current property use.

The subject property is located in the NE ¼ of the SW ¼, and the NW ¼ of the SE ¼, Section 19 of Township 29 North, Range 5 East, Willamette Meridian. According to the United States Geological Survey topographic map of Everett, Washington, the property is located approximately 10 feet above mean sea level.

## 1.3 Previous Investigations

PEG is not aware of any previous environmental investigations performed at the former Bulk Plant facilities with respect to petroleum hydrocarbons.

Based on information provided by PTI Environmental Services Inc., assessment and remediation activities have occurred on and directly adjacent to the Mobil/American Distributing Co. site, that is located directly south of the Kimberly-Clark mill. In August and October of 1995, the U.S. Coast Guard responded to an oil discharge in Port Gardner Bay that was traced to the City of Everett combined sewer outfall (CSO). The CSO line runs east-west directly south of the Kimberly-Clark warehouse (Figure 2). The oil from the discharge was matched to a sample from the Mobil/American Distributing Co. site.

In April 1996, an Agreed Order was issued by Ecology to Mobil and American Distributing Co., which focused on elimination of oil discharge from the CSO line, followed by definition of the nature and extent of contamination. In June and July 1996, the CSO line was excavated and repaired. Approximately 23,000 gallons of #3 or #4 fuel oil were recovered during dewatering activities for the CSO line repair by Mobil/American Distributing Co. Approximately 800 cubic yards of petroleum contaminated soil were hauled off-site for disposal by Mobil/American Distributing Co.

## 2.0 INVESTIGATIVE PROCEDURES

---

### 2.1 Soil Probe Installation

Transglobal Environmental Geosciences Northwest Inc. (TEG) of Olympia, Washington installed fourteen exploratory soil probes (Probe 2 through Probe 15) to depths ranging from 4 to 13 feet below grade on November 17 and 18, 1997. Soil probe locations were positioned in proximity to former facilities on the Site that could be potential sources of petroleum hydrocarbons, and adjacent to the CSO line. A direct-push hydraulic drive point system was used and a PEG geologist using the Unified Soil Classification System logged the borings. Following the collection of soil samples, the borings were abandoned by grouting with a bentonite sealant to the surface. Investigative procedures are presented in Appendix A. Soil probe locations are presented on Figure 2. Soil probe logs are presented in Appendix B.

#### 2.1.1 Soil and Groundwater Sampling

Soil Probe 1 could not be accessed with the Strataprobe rig, therefore a soil sample was collected from this location utilizing a stainless steel hand auger. Soil samples were collected continuously from a depth of one foot below grade to the bottom of the soil borings in soil Probe 2 through Probe 4, and Probe 7 through Probe 15, utilizing a direct-push hydraulic drive point system. Soil samples were collected continuously from a depth of three feet and two feet below grade in soil Probe 5 and Probe 6, respectively. Soil samples retained for chemical analyses were placed in laboratory supplied sample jars with Teflon<sup>®</sup> lined lids. The samples were placed on ice during transport and submitted to North Creek Analytical, Inc. in Bothell, Washington for chemical analysis. Groundwater samples were also collected from each probe location utilizing a screened probe section which was sampled using a peristaltic pump with disposable tubing.

Soil samples were field screened for the presence of organic vapors using a Thermo Environmental Instruments Inc. Model 580B PID with a 10.0 electron volt (eV) lamp. Soil screening procedures are described in Appendix A. It should be noted that the PID measurements are considered semi-quantitative data since the instrument detects all organic compounds with ionization potentials less than 10 eV. PID results for the soil samples ranged from non-detectable levels to 86 parts per million (ppm). In addition, the soil samples were

field screened for oil sheens. Oil sheen screening procedures are presented in Appendix A. The results of this field screening are also recorded on the exploratory boring logs in Appendix B.

## **2.2 Soil Borings and Monitoring Well Installation**

Two exploratory soil borings (KC-1 and KC-2) were drilled by Cascade Drilling of Bothell, Washington on January 16, 1998. The boring locations were chosen to determine if the former facilities might have contributed to the petroleum hydrocarbons observed in the CSO line excavation. The borings were installed to depths of approximately 16.5 feet below the floor within the existing Kimberly-Clark warehouse. The borings were moved slightly from the original locations in the sampling and analysis workplan to avoid high-traffic areas. Holes were cut through the concrete floor to allow drilling equipment to access the soil.

There was an open space between the warehouse floor and the ground surface. The ground surface was approximately five feet below the concrete warehouse floor at Well KC-1, and approximately 4.5 feet below the floor at Well KC-2. The casings for these two wells protrude above the ground surface and are completed just below the warehouse floor to allow access from within the warehouse. The exploratory boring logs show detail of this well completion arrangement.

### **2.2.1 Soil Sampling**

Eight-inch outside diameter hollow-stem auger drilling equipment was used and a PEG geologist using the Unified Soil Classification System logged the borings. Initial soil samples were collected at approximately seven and nine feet below the warehouse floor, and sampling continued thereafter at approximately five-foot intervals to the total depth explored. Soil samples for chemical analyses were retained in laboratory-supplied glass jars with Teflon™ lined lids. The samples were placed on ice for transport to North Creek Analytical, Inc. accompanied by chain-of-custody documentation. Investigative procedures and sample preservation techniques are presented in Appendix A. Boring locations are shown on Figure 2. Soil samples were field screened for oil sheens and for the presence of organic vapors using a PID. PID test procedures and oil sheen field screening procedures are described in Appendix A. The results of the field screening are recorded on the exploratory boring logs in Appendix B.

### **2.2.2 Well Casing Installation**

The two borings were converted to groundwater monitoring wells (KC-1 and KC-2) with the installation of 2-inch diameter, Schedule 40 PVC casing with 0.020-inch factory slotted screen. The well screen was placed across the saturated zone and extended from approximately 2 feet to 10 feet below ground surface in Well KC-1, and from approximately 1.5 feet to 11.5 feet

below ground surface in Well KC-2. Ground surface refers to the soil surface below the warehouse floor. Refer to the boring logs in Appendix B for specific information on well construction. The annular space of each well was packed with a graded 10x20 Colorado silica sand. The sand pack was placed across the entire screened interval, extending approximately six inches above the top of the screens. The annular space of each well was then sealed with hydrated bentonite chips to the ground surface beneath the warehouse floor. A plug-type locking device was installed at the top of each monitoring well. A metal plate able to withstand forklift traffic was placed in the opening of the concrete floor. Soil cuttings generated during drilling remained beneath the warehouse floor.

### **2.2.3 Well Development and Groundwater Sampling**

Monitoring Wells KC-1 and KC-2 were developed on January 16, 1998 by surging and bailing. Well development procedures and records are presented in Appendix A.

Groundwater samples were collected from Wells KC-1 and KC-2 on January 19, 1998. Depths to groundwater in Wells KC-1 and KC-2 on this date were 6.53 feet and 5.78 feet below top of casing, respectively. Well locations are shown on Figure 2.

Prior to sampling, each well was visually checked for the presence of sheens using a clear single-use disposable polyethylene bailer. No sheens were observed in the wells. The wells were then purged of a minimum of three casing volumes of water by bailing. Groundwater samples were collected after the wells recovered to at least 60 percent of the pre-purge static water level. Samples were collected with a single-use disposable bailer. Groundwater sampling procedures are described in detail in Appendix A. Field sampling data sheets are also presented in Appendix A.

One blind duplicate sample (KC-X) was collected from Monitoring Well KC-2. One trip blank sample (Trip Blank) was also prepared utilizing laboratory provided deionized water, and was carried throughout the sampling event.

Development and purge water was placed directly into the mill's wastewater disposal system.

### 2.3 Analytical Program

Soil and groundwater samples that were selected for laboratory testing were analyzed for one or more of the following parameters:

<u>PARAMETER</u>	<u>METHOD</u>
Total Petroleum Hydrocarbons as gasoline (TPH-gasoline)	Washington Method WTPH-G
TPH-diesel and TPH-oil	Washington Method WTPH-D plus Extended
Benzene, toluene, ethyl benzene and xylenes (BTEX compounds)	EPA Method 8020

The samples were analyzed by North Creek Analytical of Bothell, Washington.



## 3.0 FINDINGS

---

### 3.1 Subsurface Conditions

In general, soil encountered during soil probe and monitoring well installations consisted of silty sand, and sand. Occurrences of clay, wood, and organic material were also noted in some locations. Boring logs that show detailed lithologic descriptions are included in Appendix B. Groundwater was generally encountered during soil probe installation at depths less than five feet below grade. Measurable thicknesses of separate-phase hydrocarbons were not observed in any of the soil probe or boring locations. Hydrocarbon sheens were noted in soil samples from Probe 6, Probe 7, and Probe 11. On January 19, 1998, depth to groundwater in Monitoring Wells KC-1 and KC-2 was 6.53 feet and 5.78 feet below top of casing, respectively, which is approximately 1.5 feet below the ground surface under the warehouse floor.

### 3.2 Sample Analytical Results

#### 3.2.1 Soil

A total of three soil samples were submitted for analysis from soil Probe 7, soil Probe 11, and Boring KC-1. The soil samples collected from the soil probes were submitted for analysis based on the observation of sheens during field screening. The soil sample submitted from Boring KC-1 was collected from just above the groundwater interface. Concentrations of TPH-gasoline, TPH-diesel, and TPH-oil were detected in the three soil samples, however all concentrations were below the respective MTCA Method A cleanup levels.

*only  
3 samples*

The soil analytical results are summarized in Table 1. Laboratory analytical reports and chain-of-custody documentation are included in Appendix C. Figure 2 should be referenced for sample locations.

#### 3.2.2 Groundwater

Groundwater samples from Probe 3, Probe 4, Probe 5, Probe 7, and Probes 10 through 15 contained detectable concentrations of TPH-gasoline, TPH-diesel, TPH-oil, or BTEX compounds. However, only the samples from Probe 7, Probe 11, Probe 13, and Probe 14

contained TPH-diesel and/or TPH-oil concentrations exceeding MTCA Method A cleanup levels. The samples from Probe 7 and Probe 11 (closest to the CSO line) contained the highest TPH concentrations. Concentrations of TPH-diesel in Probe 7 and Probe 11 were 52,400 parts per billion (ppb) and 56,000 ppb, respectively. Concentrations of TPH-oil in Probe 7 and Probe 11 were 38,400 ppb and 43,900 ppb, respectively. Groundwater analytical results are summarized in Table 2.

The groundwater sample from Well KC-1 contained a detectable concentration of TPH-diesel, below the MTCA Method A cleanup level. The sample from Well KC-2 contained no detectable concentrations of TPH or BTEX compounds. Groundwater analytical results are summarized in Table 2.

A blind duplicate water sample (KC-X) was submitted for analysis, along with a trip blank. The blind duplicate was a duplicate sample from Well KC-2. The blind duplicate contained detectable concentrations of TPH-gasoline and TPH-diesel. Blind duplicate sample KC-X does not correlate with the non-detectable concentrations observed in the sample from Well KC-2, and may indicate a field or laboratory error. However, the concentrations reported in Sample KC-X were not significantly higher than the method reporting limits, and may represent a statistical variation in the laboratory analysis. Concentrations of TPH or BTEX were not detected in the trip blank sample.

Laboratory analytical reports and chain-of-custody documentation are included in Appendix C. Figure 3 should be referenced for sample locations and TPH concentrations.

## 4.0 CONCLUSIONS

---

Based on laboratory analytical data, the following conclusions can be made:

- No measurable thicknesses of separate-phase hydrocarbons were identified in any of the soil probes or monitoring wells installed during this investigation.
- Detected concentrations of TPH-gasoline, TPH-diesel, TPH-oil, and toluene in the soil samples analyzed from the exploratory soil probes and borings did not exceed the respective Washington State Model Toxics Control Act (MTCA) Method A cleanup levels.
- Groundwater samples collected from soil Probe 7 and soil Probe 11 (nearest the CSO line) exceeded the MTCA Method A cleanup level for TPH-diesel at levels of 52,400 ppb and 56,000 ppb, respectively.
- Groundwater samples collected from soil Probe 7 and soil Probe 11 (nearest the CSO line) exceeded the MTCA Method A cleanup level for TPH-oil at levels of 38,400 ppb and 43,900 ppb, respectively.
- Groundwater samples collected from soil Probe 13, and soil Probe 14 exceeded the MTCA Method A cleanup level for TPH-oil at levels of 1,420 ppb and 2,930 ppb, respectively.
- All other detected concentrations of BTEX compounds, TPH-gasoline, TPH-diesel, and TPH-oil in groundwater samples were below the MTCA Method A cleanup levels.

The analytical results from the soil probes and groundwater monitoring wells demonstrate that the highest concentrations of hydrocarbons in soil and groundwater are found immediately adjacent to the CSO line. There is no evidence from this investigation that the former facilities located north of the CSO line contributed to the separate phase hydrocarbons encountered during repair of the CSO line.

## 5.0 SIGNATURES OF ENVIRONMENTAL PROFESSIONALS

---

### ENVIRONMENTAL INVESTIGATION

2600 Federal Avenue

Everett, Washington

February 12, 1998.

PEG Project Number 520-165.1A

This report prepared for:

Chevron Products Company, Texaco Refining and Marketing Inc., Kimberly-Clark, and BNSF

by:

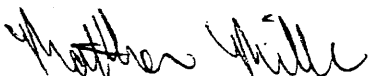

Matthew Miller

Project Geologist

and reviewed by:

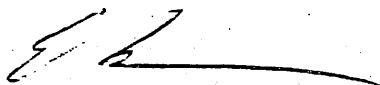

Eric Larsen

Senior Geologist

### **Pacific Environmental Group, Inc.**

4020 - 148th Avenue NE,

Suite B

Redmond, Washington 98052

(425) 869-5099

(425) 869-5639 (FAX)

**TABLE 2  
GROUNDWATER ANALYTICAL RESULTS**

Former Bulk Fuel Facilities  
2600 Federal Avenue  
Everett, Washington

Sample I.D.	Date	Benzene (ppb)	Toluene (ppb)	Ethyl- benzene (ppb)	Xylenes (ppb)	TPH- Gasoline (ppb)	TPH- Diesel (ppb)	TPH-Oil (ppb)
Probe 2	11/17/97	ND	ND	ND	ND	ND	ND	ND
Probe 3	11/17/97	ND	ND	ND	ND	ND	ND	766
Probe 4	11/17/97	0.877	0.569	0.602	2.52	137	276	ND
Probe 5	11/17/97	ND	ND	ND	ND	64.6	ND	ND
Probe 6	11/17/97	ND	ND	ND	ND	ND	ND	ND
Probe 7	11/17/97	ND	ND	ND	ND	327	52,400	38,400
Probe 8	11/17/97	ND	ND	ND	ND	ND	ND	ND
Probe 9	11/17/97	ND	ND	ND	ND	ND	ND	ND
Probe 10	11/17/97	ND	0.672	ND	ND	ND	ND	ND
Probe 11	11/17/97	ND	ND	ND	4.86	736	56,000	43,900
Probe 12	11/17/97	ND	0.715	ND	ND	ND	ND	ND
Probe 13	11/18/97	ND	ND	ND	ND	ND	ND	1,420
Probe 14	11/18/97	ND	ND	ND	ND	ND	311	2,930
Probe 15	11/18/97	ND	1.26	1.23	2.37	172	ND	ND
KC-1	01/19/98	ND	ND	ND	ND	ND	430	ND
KC-2	01/19/98	ND	ND	ND	ND	ND	ND	ND
KC-X*	01/19/98	ND	ND	ND	ND	57.9	355	ND
Trip Blank	01/19/98	ND	ND	ND	ND	ND	NA	NA
<b>MTCA Method A Cleanup Levels:</b>		<b>5.0</b>	<b>40</b>	<b>30</b>	<b>20</b>	<b>1000</b>	<b>1000</b>	<b>1000</b>
<b>Laboratory Reporting Limits:</b>		<b>0.50-1.0</b>	<b>0.50-1.0</b>	<b>0.50-1.0</b>	<b>1.00</b>	<b>50.0</b>	<b>250</b>	<b>750</b>
Concentrations reported as parts per billion (ug/l) Certified analytical results are included in Attachment B ND - Not Detected at or above the laboratory reporting limit NA - Not Analyzed * - KC-X is a duplicate sample from Well KC-2 TPH as Diesel and Oil - Analysis by Washington Method WTPH-D plus extended TPH as Gasoline - Analysis by Washington Method WTPH-G BTEX Compounds - Analysis by EPA Method 8020A								

**TABLE 1**  
**SOIL ANALYTICAL RESULTS**

Former Bulk Fuel Facilities  
2600 Federal Avenue  
Everett, Washington

Sample I.D.	Date	Depth (feet)	Benzene (ppm)	Toluene (ppm)	Ethyl-benzene (ppm)	Xylenes (ppm)	TPH-Gasoline (ppm)	TPH-Diesel (ppm)	TPH-Oil (ppm)
Probe 7-3	11/17/97	3.0	ND	0.0545	ND	ND	ND	17.6	71.1
Probe 11-4	11/17/97	4.0	ND	ND	ND	ND	20.7	19.6	52.5
KC1-8.5	01/16/98	8.5	ND	ND	ND	ND	6.50	52.7	81.8
<b>MTCA Method A Cleanup Levels:</b>			<b>0.5</b>	<b>40</b>	<b>20</b>	<b>20</b>	<b>100</b>	<b>200</b>	<b>200</b>
<b>Laboratory Reporting Limits:</b>			<b>0.050</b>	<b>0.050</b>	<b>0.050</b>	<b>0.10</b>	<b>5.0</b>	<b>10.0</b>	<b>25.0</b>
Concentrations reported as parts per million (mg/kg) Certified analytical results are included in Attachment B ND - Not detected at or above the laboratory reporting limits TPH as Diesel and Oil - Analysis by Washington Method WTPH-D plus extended TPH as Gasoline - Analysis by Washington Method WTPH-G BTEX Compounds - Analysis by EPA Method 8020A									

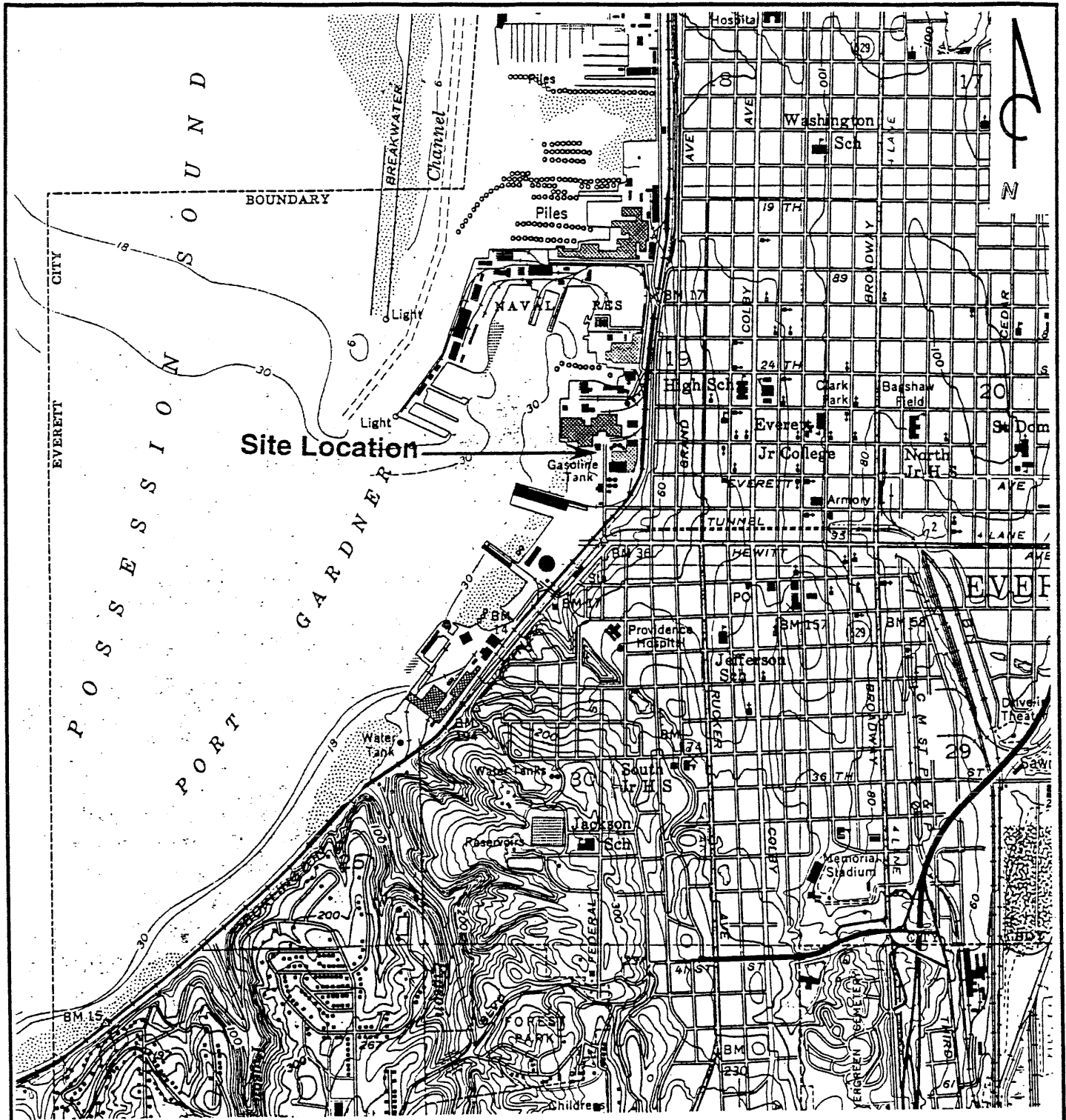

**REFERENCE:**

USGS 7.5 MIN. TOPOGRAPHIC MAP  
 TITLED: **Everett, Washington**  
 DATED: 1953 REVISED: 1968 and 1973  
 COUNTY: **Snohomish**

**SCALE: 1 to 24,000** (1 Inch = Approximately 2000 Feet)



MAP LOCATION



PACIFIC  
 ENVIRONMENTAL  
 GROUP, INC.

**FORMER BULK FUEL FACILITIES**  
 2600 Federal Avenue  
 Everett, Washington

**SITE LOCATION MAP**

FIGURE:  
**1**  
 PROJECT:  
 520-165.1A

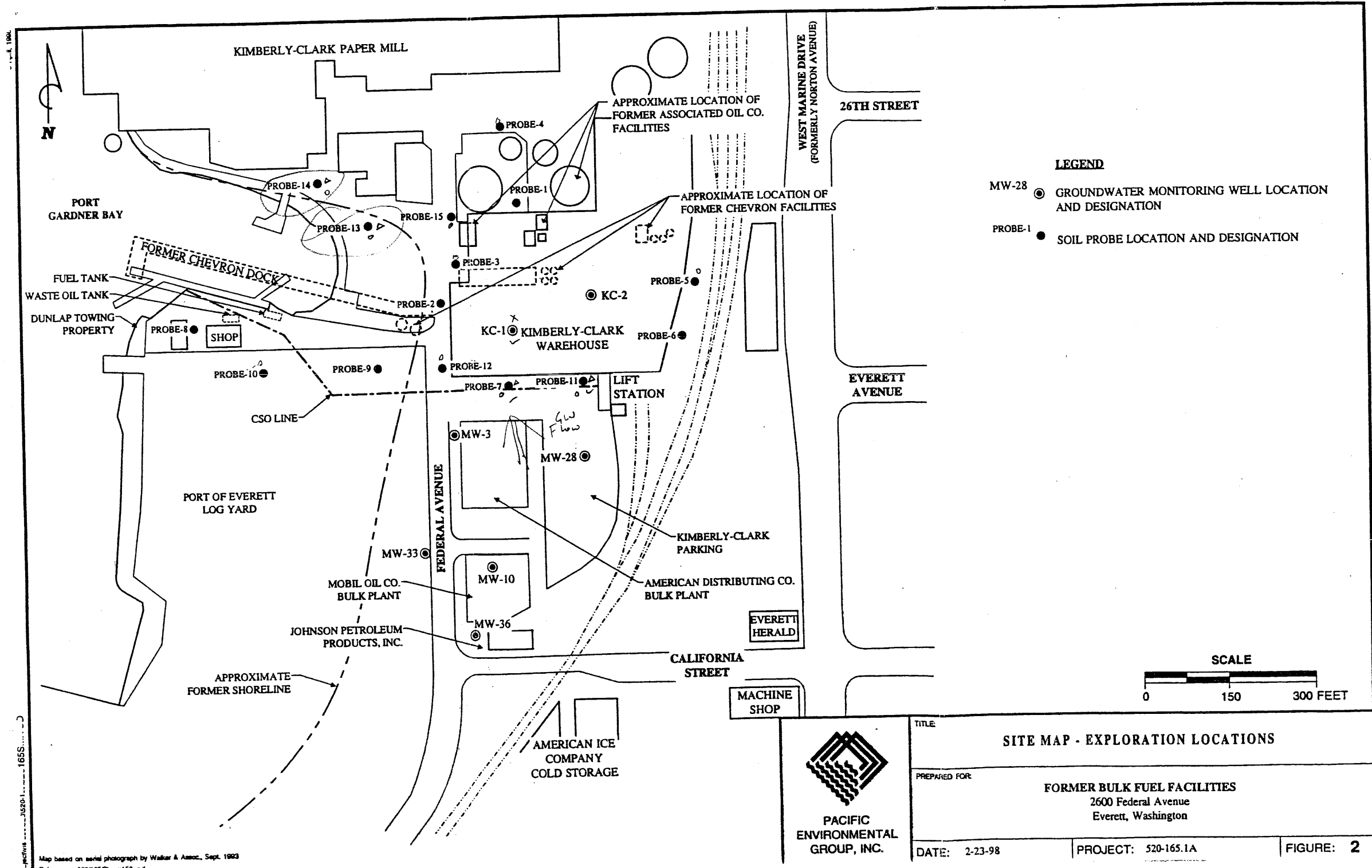



9 April 1998

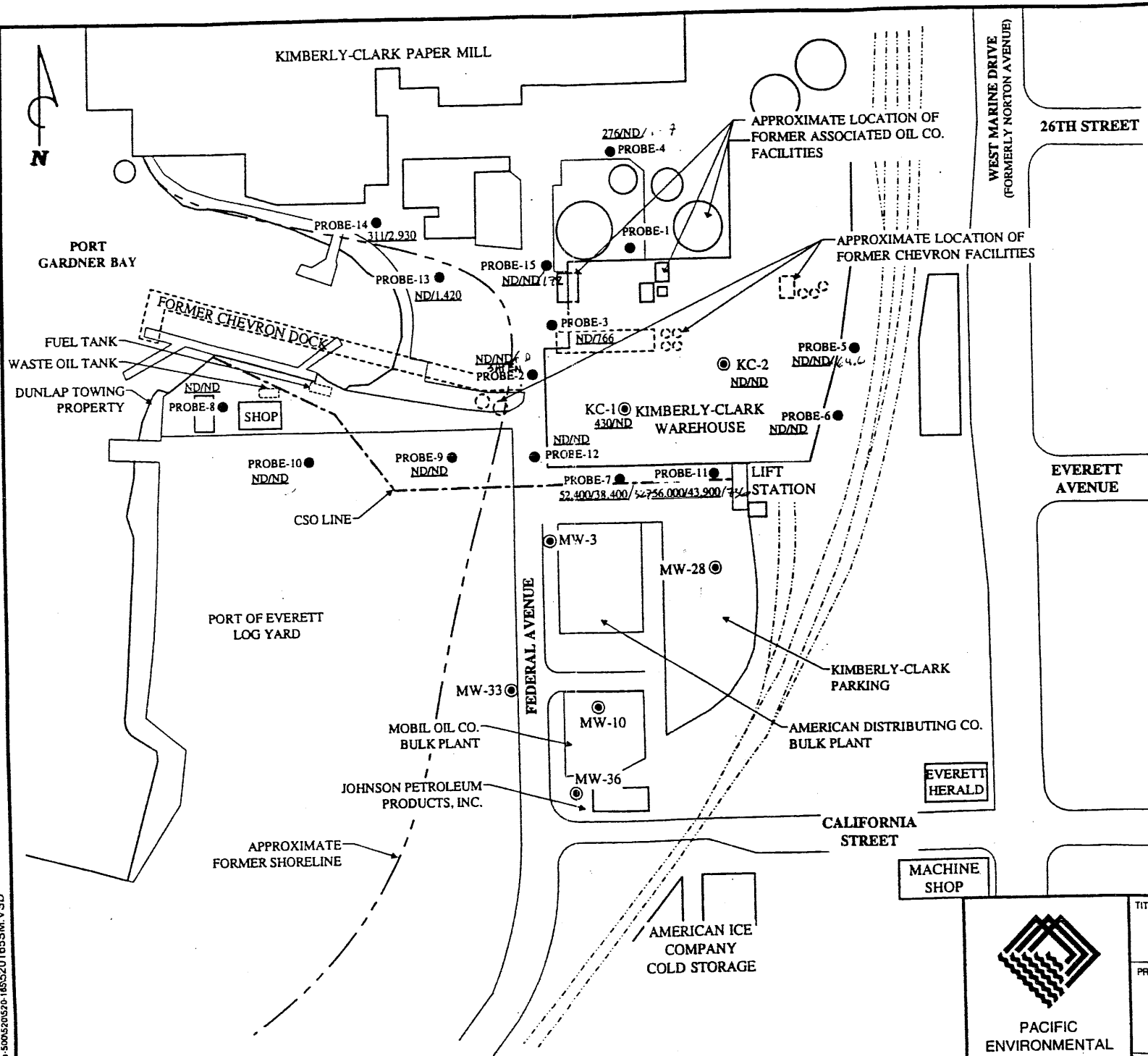

- LEGEND**
- MW-28 ● GROUNDWATER MONITORING WELL LOCATION AND DESIGNATION
  - PROBE-1 ● SOIL PROBE LOCATION AND DESIGNATION
  - ND/766 TPH-DIESEL/TPH-OIL CONCENTRATIONS IN GROUNDWATER, IN PARTS PER BILLION
  - ND NOT DETECTED

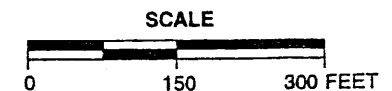

I:\projects\500520165\5201655M.VSD

Map based on aerial photograph by Walker & Assoc., Sept. 1993  
Reference: 520165/Stamp150.vsd



TITLE <b>SITE MAP - GROUNDWATER SAMPLE CONCENTRATIONS</b>		
PREPARED FOR: <b>FORMER BULK FUEL FACILITIES</b> 2600 Federal Avenue Everett, Washington		
DATE: 2-23-98	PROJECT: 520-165.1A	FIGURE: <b>3</b>

## **APPENDIX E**

Addendum Sampling and Analysis Plan



**ADDENDUM TO DRAFT FOCUSED FEASIBILITY  
STUDY SAMPLING AND ANALYSIS WORK PLAN  
ExxonMobil / ADC Property, Ecology Site ID 2728  
2717/2731 Federal Avenue  
Everett, Washington**

Submitted to:

**ExxonMobil Environmental Services**  
East Providence Terminal  
1001 Wampanoag Trail  
Riverside, Rhode Island 02915

and

**American Distributing Company**  
13618 45th Avenue NE  
Marysville, Washington 98271

Submitted by:

**AMEC Earth & Environmental, Inc.**  
11810 North Creek Parkway North  
Bothell, Washington 98011

February 10, 2010

AMEC Project No. 0-915-15716-D

## TABLE OF CONTENTS

		<u>Page</u>
1.0	INTRODUCTION.....	1
1.1	Property History.....	1
2.0	OBJECTIVES.....	1
3.0	PROJECT ORGANIZATION AND RESPONSIBILITIES.....	2
4.0	DATA QUALITY OBJECTIVES.....	2
5.0	PRE-FIELD ACTIVITIES.....	5
6.0	FIELD PROCEDURES.....	5
6.1	Field Health and Safety Procedures.....	5
6.2	Field Preparation.....	6
6.3	Utility Survey.....	6
6.4	Calibration of Field Equipment.....	6
6.5	Soil Borings.....	6
6.6	Soil Sample Collection.....	7
6.7	Soil Sample Analyses.....	8
6.8	Groundwater Sample Collection.....	9
6.9	Groundwater Sample Analyses.....	9
6.10	Sample Containers, Preservation and Storage.....	9
6.11	Equipment Decontamination.....	9
6.12	Investigation Derived Waste Management.....	10
7.0	DOCUMENTATION.....	11
7.1	Field Logbook.....	11
7.2	Labeling.....	11
7.3	Sample Chain of Custody.....	12
8.0	DATA VALIDATION.....	12
9.0	QUALITY CONTROL.....	13
9.1	Field Quality Control Samples.....	13
9.2	Laboratory Quality Control Samples.....	13
9.3	Field Variances.....	13
9.4	Data Management.....	13
10.0	REFERENCES.....	14

### **LIST OF TABLES**

Table 1	Method Detection and Reporting Limits in Soil Samples
Table 2	Method Detection and Reporting Limits in Groundwater Samples
Table 3	Proposed Total Boring Depth and Soil and Groundwater Samples
Table 4	Sample Containers, Preservation and Storage

### **LIST OF FIGURES**

Figure 1	Site Location Map
Figure 2	Proposed Storm Water Upgrade Soil Boring Locations
Figure 3	Clearance Distance in Vicinity of Proposed Borings

### **LIST OF ATTACHMENTS**

Attachment A1	Boring Logs for MW-A1 and MW-A2
Attachment A2	Site-Specific Health and Safety Plan
Attachment A3	City of Everett Street Use Permit Documentation
Attachment A4	Field Documentation Forms

## ACRONYMS AND ABBREVIATIONS

ADC	American Distributing Company
AMEC	AMEC Earth & Environmental, Inc.
bgs	below ground surface
BTEX	benzene, toluene, ethylbenzene, and xylenes
COC	chain-of-custodies
CSS	Colorado silica sand
DQIs	data quality indicators
DQOs	data quality objectives
Ecology	Washington State Department of Ecology
EDB	ethylene dibromide
EDC	1,2-dichloroethane
EPA	U.S. Environmental Protection Agency
ExxonMobil	ExxonMobil Oil Corporation
FFS	Focused Feasibility Study
HASP	Health and Safety Plan
HSA	hollow stem auger
IDW	investigation derived waste
mg/kg	milligram per kilograms
mg/L	milligram/liter
MDLs	method detection limits
MS/MSD	matrix spike/matrix spike duplicate
mV	millivolt
PAHs	polycyclic aromatic hydrocarbons
PID	photoionization detector
PPE	personal protective equipment
ppm	parts per million
PVC	polyvinyl chloride
Property	ExxonMobil/ADC Property
QA	quality assurance
QC	quality control
RPD	relative percent difference
SAP	Sampling and Analysis Plan
SD	standard deviation
TPH-D	total petroleum hydrocarbons–diesel
TPH-O	total petroleum hydrocarbons–oil
TPH-G	total petroleum hydrocarbons–gasoline
VOCs	volatile organic compounds
WAC	Washington Administrative Code
WP	Work Plan

## **1.0 INTRODUCTION**

AMEC Earth & Environmental, Inc., (AMEC) has prepared this Addendum to the October 2009 Draft Final Focused Feasibility Study (FFS) Sampling and Analysis (SAP) Work Plan (WP) on behalf of ExxonMobil Oil Corporation (ExxonMobil) and the American Distributing Company (ADC). This Addendum outlines additional soil and groundwater characterization activities that will be conducted to the north and west of the ExxonMobil/ADC Property (the Property) located at 2717 and 2731 Federal Avenue in Everett, Washington (Figure 1). The City of Everett (the City) is planning to upgrade the storm sewer line that will result in trenching within Everett Avenue and Federal Avenue. In advance of trenching, samples of the soil and groundwater will be collected from borings to determine soil and groundwater disposal options. This Addendum addresses the specific field sampling activities related to the borings, chemical analyses, and quality assurance (QA) procedures associated with borings along the utility alignment.

### **1.1 Property History**

Historically, total petroleum hydrocarbons as diesel (TPH-D), oil (TPH-O), and gasoline (TPH-G), benzene, toluene, ethylbenzene, xylenes, polycyclic aromatic hydrocarbons (PAHs), and lead were found in soil and groundwater beneath the Property and beneath properties to the west, north, and east. Petroleum contamination has resulted from past releases from former operations at the ExxonMobil and ADC Parcels and other similar businesses in the area.

## **2.0 OBJECTIVES**

The objective of the soil and groundwater characterization beneath Everett Avenue and Federal Avenue is to collect sufficient analytical data for disposal classification. Elements of this addendum are based on the Washington Administrative Code (WAC) Ecology Model Toxics Control Act (MTCA) Cleanup Regulations WAC 173-340-820 and City of Everett Waste Water discharge regulations. The proposed location for the disposal of soil from the utility excavation is the CEMEX facility in Everett. The soil and groundwater sampling will include the following activities:

1. Advance five borings (three along Everett Avenue and two along Federal Avenue [Figure 2]) to evaluate the concentration of chemicals in soil and groundwater. The borings will be advanced at each location using a hollow stem auger (HSA) drill rig to the total depth of the proposed trench at the location of each boring. Two of the borings will be terminated at a minimum depth of 20 feet below ground surface (bgs) to provide soil lithology information for the City's geotechnical engineer.
2. Collect continuous samples from the borings using a standard penetration test (SPT) and a split spoon (SS).

3. Collect two to three composite soil samples from each boring for laboratory analyses. The first composite will be from the top four feet and the second from the lower four feet. Discreet samples for volatile organic compounds (VOC) analysis will be collected from the upper four feet and from the SPT.
4. Collect “grab” water samples from each boring. If sheen or product is encountered, an additional water sample will be collected from just below the water table (a foot or two below).
5. Soil samples will be analyzed for CEMEX acceptance criteria and “grab” groundwater samples will be analyzed for the City of Everett sanitary sewer discharge criteria. The soil and groundwater samples will be performed on a one-week turn-around schedule.

### **3.0 PROJECT ORGANIZATION AND RESPONSIBILITIES**

The project is organized as follows:

ExxonMobil and ADC are the owners of the Property.

AMEC Earth & Environmental, Inc. (AMEC) is the environmental consultant for this project.

- Gary Dupuy (phone number 206-342-1777) and Meg Strong (phone number 425-368-0966) are the client managers for the project.
- Leah Vigoren (phone number 206-838-8470) is the project manager and is responsible for project management. Technical and administrative elements are included in her project management responsibilities.
- Anastasia Speransky (phone number 206-838-1776) is the task manager for the project and quality assurance manager for this project, which includes data quality objectives, and quality assurance/quality control (QA/QC) objectives as well as health and safety.

Cascade Drilling, Inc. in Woodinville, Washington, is the drilling contractor for the project.

Test America, Inc., in Nashville, Tennessee, is responsible for managing analyses of the samples collected. The laboratory is also responsible for sample preparation and ensuring that the QA/QC results from the laboratory are valid.

The geotechnical engineer will be provided by the City of Everett.

### **4.0 DATA QUALITY OBJECTIVES**

Data Quality Objectives (DQOs) is a quality management tool developed by the U.S. Environmental Protection Agency (EPA) that is used to facilitate the planning of data collection activities. The DQO process provides a systematic procedure for defining criteria in the data collection design. The primary reference for the formal DQO process is EPA’s guidance document (EPA 1994). The DQO process consists of the following seven key steps.



1. State the problem.
2. Identify the decision.
3. Identify the inputs to the decision.
4. Define the boundaries of the study.
5. Develop a decision rule.
6. Specify tolerable limits on decision errors.
7. Optimize the design for obtaining data.

DQOs are qualitative and quantitative statements, developed using the DQO process, that are intended to clarify study objectives, define an appropriate type of data, and specify tolerable levels of potential decision errors that will be used as the basis for establishing the quality and quantity of data needed to support decisions.

Data Quality Indicators (DQI) (accuracy, precision, completeness, representativeness, comparability, and method detection limits) refer to quality control criteria established for various aspects of data gathering, sampling, or analysis activity. In defining DQIs specifically for the project, the level of uncertainty associated with each measurement is determined.

**Accuracy** is the degree of agreement of a measurement with a known or true value. To determine accuracy, a laboratory or field value is compared to a known or true concentration. Accuracy is determined by such quality control (QC) indicators as: matrix spikes (MS), surrogate spikes, laboratory control samples (blind spikes) and performance samples.

**Precision** is the degree of mutual agreement between or among independent measurements of a similar property (usually reported as a standard deviation [SD] or relative percent difference [RPD]). This indicator relates to the analysis of duplicate laboratory or field samples. An RPD of  $\leq 50\%$  for water and  $\leq 50\%$  for soil, depending upon the chemical being analyzed, is generally acceptable. Typically field precision is assessed by field duplicates and laboratory precision is assessed using laboratory duplicates, matrix spike duplicates, or laboratory control sample duplicates).

**Completeness** is expressed as percent of valid usable data actually obtained compared to the amount that was expected. Due to a variety of circumstances, sometimes either not all samples scheduled to be collected can be collected or else the data from samples cannot be used (for example, samples lost, bottles broken, instrument failures, laboratory errors, etc.). The minimum percent of completed analyses defined in this section depends on how much information is needed for decision making. Generally, completeness percent goals increase when the fewer the number of samples are collected per event or the more critical the data are for decision making. Goals in the 90 to 95% range are typical.

**Representativeness** is the expression of the degree to which data accurately and precisely represent a characteristic of an environmental condition or a population. It relates both to the

area of interest and to the method of taking the individual sample. The idea of representativeness should be incorporated into discussions of sampling design. Representativeness is best assured by a comprehensive statistical sampling design, but it is recognized that this is usually outside the scope of most one-time events. Most one-time event SAPs focus on issues related to judgmental sampling and why certain areas are included or not included and the steps being taken to avoid either false positives or false negatives.

**Comparability** expresses the confidence with which one data set can be compared to another. The use of methods from EPA or “Standard Methods” or from some other recognized sources allows the data to be compared facilitating evaluation of trends or changes in a site, a river, groundwater, etc. Comparability also refers to the reporting of data in comparable units so direct comparisons are simplified (e.g., this avoids comparison of milligram/liter (mg/L) for nitrate reported as nitrogen to mg/L of nitrate reported as nitrate, or parts per million (ppm) vs. mg/L discussions).

**Detection Limit(s)** (usually expressed as method detection limits [MDLs] or Quantitation Limit[s]) for all analytes or compounds of interest for all analyses requested is presented in Tables 1 and 2. These limits should be related to any decisions that will be made as a result of the data collection effort. A critical element to be addressed is how these limits relate to any regulatory or action levels that may apply.

### **Data Review and Management**

Data management will commence during the field investigation. Each soil and groundwater sample collected will be recorded in a bound field book which will include a description of the location, depth, matrix, sample ID, and date and time of collection. Once data has returned from the laboratory, the electronic deliverables will be reviewed to ensure the receipt of all requested analytes and again cross-checked with chain-of-custodies (COCs). Data will be tabulated in electronic spreadsheets and again checked to ensure proper entry before use in reporting.

### **Assessment Oversight**

The project manager will ensure that sample methods and accurate documentation are being practiced. Quality assurance (QA) systems will be emplaced at regular intervals during the data management process as described above. Finally, a peer review process by a senior technical staff will be conducted on the final reporting.

### **Corrective Actions**

Corrective actions, if necessary, shall be completed. If acceptance criteria were not met and a corrective action was not successful or corrective action was not performed, data will be flagged appropriately. Requirements and procedures for documenting the need for corrective actions are described in this section.

Items requiring corrective action in the laboratory shall be documented by the use of a corrective action report. The QA coordinator or any other laboratory member can initiate the corrective action report request in the event QC results exceed acceptability limits, or upon identification of some other laboratory problem. Corrective actions can include reanalysis of the sample or samples affected, re-sampling and analysis, or a change in procedures, depending upon the severity of the problem.

## 5.0 PRE-FIELD ACTIVITIES

AMEC will coordinate the field activities and contract a private utility locating service in addition to contacting the underground utilities location center (Call Before You Dig). In addition, AMEC will update an existing site-specific Health and Safety Plan (HASP) (Attachment A2).

Site access for the borings on Everett Avenue which is owned by Kimberly Clark will be obtained by the City of Everett. AMEC will prepare and submit to the City the traffic control plan and right of way access applications for the work (Attachment A3).

## 6.0 FIELD PROCEDURES

This section presents the field investigation procedures for the soil and groundwater sampling effort. The field investigation will consist of drilling soil borings and collecting soil and groundwater samples. The proposed soil boring locations are illustrated on Figure 2. The proposed soil boring depths and specifications are listed in Table 3.

### 6.1 Field Health and Safety Procedures

AMEC field personnel will adhere to the health and safety procedures detailed in the *Site-Specific Health and Safety Plan*. City staff must follow their own Health and Safety Plan.

The hospital closest to the Site is Providence Hospital. An emergency contact list and a map illustrating the emergency route to Providence Hospital are located in the *Health and Safety Plan*.

It is anticipated that all fieldwork will be performed using Level D modified personal protective equipment (PPE). At a minimum, each on-site worker will be required to wear safety footwear (steel-toed boots), hard hat, hearing protection, eye protection, and a high visibility safety vest. In addition, AMEC and AMEC's contractors will be required to wear hand protection (e. g. leather and/or nitrile gloves). PPE will be upgraded whenever there is a potential for direct contact with contaminated soil or groundwater. Changes in the required PPE will be based on changed work conditions and field observations. PPE upgrades may consist of the following:

- Tyvek Coveralls – if a splash transfer is considered likely;
- Additional PPE upgrades that may be required, depending on breathing zone levels of petroleum hydrocarbons detected.

Eating, drinking, chewing gum or tobacco, smoking, or any practice that involves hand-to mouth contact increases the probability of contaminant ingestion and is prohibited in any area where the possibility of contamination exists.

Potential physical hazards that may be encountered include heat stress, slips, trips, and falls.

The AMEC field team will have current certifications for first aid, and a cell phone will be available at all times while personnel are in the field. All emergency response services will be reached by calling 911, from a land line if available.

## **6.2 Field Preparation**

A Right of Way permit will be prepared and submitted to the City of Everett. The Traffic Control Plan is included in Attachment A3.

## **6.3 Utility Survey**

AMEC will arrange a meeting with the City of Everett to mark the boring locations prior to initiation of field activities. During the markings of the borings, AMEC will identify all aboveground and overhead power lines. Proposed boring locations that are within 25 feet of an overhead power line will be moved until clearance is achieved. AMEC will also oversee a geophysical survey conducted by a private utility locator to identify subsurface utilities within 25 feet of the proposed soil boring locations. The presence of below-grade utilities will be identified, and their inferred locations will be marked on the ground surface at the site. In addition, subsurface activity locations may be reviewed with the City, if available at the time. During the utility location by the private contractor, the area noted as the former underground fuels lines will be specifically investigated in an attempt to identify the position of the pipes.

## **6.4 Calibration of Field Equipment**

Calibration of a photo-ionization detector (PID) will occur daily at the beginning of field activities. Calibration results and times will be recorded in the field notes.

Calibration instructions for the PID are included with the equipment manuals enclosed in the equipment cases. In general, the PID will be used to screen soil for the presence of lighter end petroleum hydrocarbons, such as gasoline and benzene.

## **6.5 Soil Borings**

Three soil borings (CE-1 through CE-3) will be advanced along Everett Avenue and two soil borings (CE-4 and CE-5) will be advanced along Federal Avenue (Figure 2). The borings will be advanced at each location using a HSA drill rig. Soil borings CE-1, CE-3, and CE-4 will be terminated at the total depth of the proposed trench at the location of each boring (approximately 8 feet bgs at each location). Soil borings CE-2 and CE-5 will be terminated at a minimum depth of 20 feet bgs to provide soil lithology information for the City. Proposed soil boring depths and specifications are listed in Table 3.

Per ExxonMobil Standard Operation Procedures (SOPs), 4-foot subsurface clearance will be performed by hand augering and vactor truck. The auger with round edges will be turned slowly and not forced through the soil. All soil boring locations are subject to change based on observed conditions in the field (aboveground and belowground utilities, existing equipment, etc.).

## 6.6 Soil Sample Collection

The purpose of the soil sampling is to characterize soil for proper disposal so that the City can direct load onto a truck during trenching. The first four feet generated during the hand augering for utility clearance will be composited to form the first sample. The second composite sample will be generated by blending continuous discreet soil samples collected by SPT from four to eight feet. Discrete samples for VOC and gasoline analysis will be taken from the composited upper sample and from the SPT.

The City of Everett's geotechnical engineer will log the lithology and obtain samples for grain size distribution analysis. AMEC's field representative will examine relevant chemical sample information (e.g., visual and olfactory observation and PID measurement) and will collect soil samples for laboratory analyses.

The guideline for the soil samples to be collected is as follows: In each boring, AMEC will collect two composite soil samples from two sampling intervals (1) the interval from the ground surface to 4 feet bgs using a hand auger and (2) from 4 feet bgs to the bottom of the boring (trench depth – approximately 8 feet). For composite soil samples, soil from each interval will be placed into a heavy 1-quart freezer Ziploc bag and mixed. Gravel and vegetation will be removed from the composite sample. If a discrete layer of asphaltic pavement is encountered, it will be excluded from the sample and its presence noted on the boring log. Composite samples will be collected in three 4-ounce soil jars. Samples will be labeled and chilled on ice in a cooler for delivery under proper chain-of-custody protocol to a Washington-certified analytical laboratory. It is assumed that AMEC will collect two to three discrete soil samples and two to three composite soil sample per boring for laboratory analyses.

Two discrete soil samples will be either collected from the composite sample between zero and four feet bgs and one the SPT. Selection of the sampling location will be based on (1) the interval that exhibited the highest VOC vapor concentration, as measured with a PID and/or (2) intervals of petroleum hydrocarbon staining or odors and/or (3) heavy contamination such as free product is encountered. If VOCs are not detected and no staining or odor is observed, the discreet samples will be collected from a the composite material and the other from below the water table. Discreet soil samples will be collected using a soil core syringe and inserted into a pre-tared 40 milliliter volatile organic analyses (VOA) vial in accordance with EPA Method 5035 sampling methodologies. In addition, a discrete soil sample will be collected in one 4-ounce soil jars for moisture analysis.

Samples for laboratory analyses below the proposed trench depth will not be collected except to assess lithology. To prevent cross contamination, any equipment repeatedly in contact with the soil will be decontaminated before and after each individual sampling attempt.

## 6.7 Soil Sample Analyses

The soil sample analytical program presented below is based on requirements of the disposal facilities (e. g. CEMEX).

A total of 11 discrete soil samples will be submitted to analytical laboratory for the following analyses:

- Gasoline range TPH, using Ecology method NWTPH as gasoline (NWTPH-Gx),
- All 11 samples will be analyzed for benzene, toluene, ethylbenzene, and total xylenes (BTEX) and up to 3 of the 11 samples will be selected and submitted for volatile organic compounds (VOCs) by EPA Method 8260B. The three samples will be selected based on visual or olfactory indications of hydrocarbons.

A total of 11 composite soil samples will be submitted to analytical laboratory for the following analyses:

- RCRA eight metals (Ag, As, Ba, Cd, Cr, Hg, Pb, Se) by U. S. Environmental Protection Agency (EPA) Method 200/6000/7000 Series.
- In addition, it is likely that a significant number of the soils may exceed the lower MTCA Method A soil cleanup limit of 19 milligrams per kilogram (mg/kg) for total chromium. A note will be placed on each chain-of-custody directing the laboratory to automatically perform a follow-up hexavalent chromium analysis using EPA Method 7196A for any sample whose total chromium result exceeds 19 mg/kg. We estimate that two samples will be requested to be analyzed for hexavalent chromium.
- If any soil analytical result (in mg/kg) is equal to or greater than 20 times the maximum concentration for the hazardous waste toxicity characteristics listed in 40 CFR 261.24 (in milligrams per liter [mg/L]), then the sample may be analyzed using Toxicity Characteristic Leaching Procedure (TCLP) using U. S. EPA Methods 1311 and 6010 series. (Sample volume will be held for TCLP analysis at the laboratory. We will direct the laboratory to provide notification prior to issuance of the laboratory report so that hold times would be met).
- Diesel and heavy oil range Total Petroleum Hydrocarbons (TPH), using Ecology Method Northwest Total Petroleum Hydrocarbon as diesel and lube oil (NWTPH-Dx). All NWTPH-Dx samples will be prepared in the analytical laboratory using silica gel acid wash to eliminate non-petroleum hydrocarbon interferences.
- Low-level polycyclic aromatic hydrocarbons (PAHs) by EPA method 8270D SIM.

Soil sample methods, required sample containers, preservation requirements, and holding times are provided in Table 4.

Soil samples will be submitted to Ecology-certified Test America, Inc. analytical laboratory located in Nashville, Tennessee for one-week turn around analytical time.

## 6.8 Groundwater Sample Collection

To collect a “grab” groundwater sample, a temporary 2-inch-diameter, flush-threaded Schedule 40 polyvinyl chloride (PVC) with a 5-foot-long slotted screen will be installed in each boring. The well screens will be installed to straddle the water table. Sand (10/20 CSS) will be placed in the annular space surrounding the screens to minimize turbidity. The sand pack will extend to a height of at least 1 foot above the top of the screen.

Following placing of a screen, water from the temporary well will be pumped using a submersible pump to minimize the amount of suspended solids, and a “grab” water sample will be collected either with a disposable bailer or peristaltic pump. AMEC will record the volume of water removed. The purged groundwater will be contained in 55-gallon drums and stored at the Property pending the analytical results and the City’s construction schedule.

## 6.9 Groundwater Sample Analyses

The groundwater sample analytical program presented below is based on the chemicals likely to be in groundwater from past uses of the Property that may be required to be tested for the holder to discharge water into Port Gardner Bay. For the City of Everett, this includes stormwater that runs through the City’s storm drain system as well as treated water discharged from Everett’s Water Pollution Control Facility. To comply with the City’s discharge regulations, five “grab” groundwater samples from the borings will be analyzed for:

- RCRA 8 metals (Ag, As, Ba, Cd, Cr, Hg, Pb, Se) by EPA Method 6010B/7470A (reporting limit less than 1 microgram per liter),
- Corrosives (pH) by field testing, and
- TPH and BTEX.

Groundwater samples will be submitted to Ecology-certified Test America, Inc. analytical laboratory located in Nashville, Tennessee for one-week turn around analytical time.

In addition, Gene Bennett, a City of Everett discharge expert, will be available at 425-257-8249 for the water discharge questions.

## 6.10 Sample Containers, Preservation and Storage

Soil and groundwater samples will be collected and placed into precleaned sample containers provided by the analytical laboratory in accordance with Table 4. Upon collection, sample containers will be sealed, labeled, chilled to 4°C in a cooler with ice, and maintained with AMEC’s custody until delivery to the project analytical laboratory, Test America, Inc., in Nashville, Tennessee.

## 6.11 Equipment Decontamination

Decontamination of sampling equipment will be performed to maintain data quality, to prevent cross contamination, and to prevent the potential introduction of contaminants into previously

unimpacted areas. Reusable sampling equipment, including the drill rig, down-hole drilling equipment, and stainless-steel materials, will be decontaminated prior to each sampling event. General decontamination procedures for nondedicated soil and groundwater sampling equipment and accessories are as follows.

- Physically remove soils using a nonphosphate detergent solution.
- Rinse with noncontaminated tap water.
- Rinse with deionized water.
- Rinse with Isopropyl alcohol.
- Air dry.

### **6.12 Investigation Derived Waste Management**

Investigation Derived Waste (IDW) generated during the course of the field investigation will be labeled and securely stored on the Property in 55-gallon drums approved by the U.S. Department of Transportation. Drums will be stored at a designated location. The various waste streams will include the following:

- Potentially contaminated liquids, including fluids derived from purging and equipment decontamination water;
- Potentially contaminated solids, principally soil cuttings; and
- Personal protective equipment (PPE).

Each drum will be labeled with standardized IDW drum labels to indicate its contents, date of collection, location from which the IDW originated, and other pertinent information. In addition, all drums will also be labeled with indelible paint sticks or pens. AMEC will maintain an inventory of the drums. The purged groundwater and soil cuttings will be stored at the Property pending the analytical results and the City's construction schedule. PPE will be placed in a separate 55-gallon drum and disposed off-site at an appropriate facility.



## 7.0 DOCUMENTATION

The integrity of data obtained from samples collected during the field investigation depends on proper sample management and handling. Proper sample management includes sample labeling, which includes assignment of a specific identification number and affixing proper identification and markings to the collected samples. Proper handling includes proper packing and transport of the sample containers.

### 7.1 Field Logbook

The field logbook serves as the primary record of field activities. Entries shall be made chronologically and in sufficient detail to allow the writer or a knowledgeable reviewer to reconstruct the applicable events. The field logbook shall be bound with consecutively numbered and water repellent pages.

At a minimum, the following information will be recorded in either the field logbook or a separate sample log sheet during the collection of each sample:

- Sample location and description;
- Sampler's name(s);
- Date and time of sample collection;
- Type of sample (soil or groundwater);
- Type of sampling equipment used;
- Field instrument readings and calibration; and
- Field observations and details related to analysis or integrity of samples (e.g., weather conditions, noticeable odors, colors, etc.).

### 7.2 Labeling

Each sample container sent to the lab will have a unique sample identification label. The following information will be included on the sample label:

- Project name and location;
- Project number;
- Sample identification number;
- Date and time of collection; and
- Initials of the sampler.

Each soil sample will be named by the boring number and depth (or depth interval) of sample collection in feet. For example, a discrete soil sample collected from soil boring CE-1 at a depth of 6 feet will have a sample designation as "CE-1-6." A composite soil sample from soil boring CE-2 at a depth interval from the surface to the soil/water interface that was encountered at 3.5

feet bgs will have a sample designation as “CE-2-0-3.5.” “Grab” groundwater samples will be named by the boring location, and identified as a grab sample with the date of sample collection. For example, a “grab” groundwater sample collected from boring CE-1 on February 22, 2010, would be named “CE1-G022210.”

Duplicate samples will be sent to the laboratory blindly. However, the location of the sample will not be revealed to the laboratory. Instead, duplicate samples will be named sequentially as Dup-1 and Dup-2. The location of the duplicate sample collection will be recorded in the field notebook.

### **7.3 Sample Chain of Custody**

COC forms will be completed at the end of each sampling day. The completed COC form(s) and samples will be kept in the possession of the field team until relinquishing the samples to the laboratory or courier service. One copy of the completed COC form will be kept by the field team, and the original COC form will be stored in a resealable plastic bag and transported in the sample container with the laboratory samples. Custody seals will be placed along the seal of each sample container in order to prevent tampering with the samples. A copy of the COC form is included in Attachment A4.

### **8.0 DATA VALIDATION**

Data validation is the procedure of reviewing data against a known set of criteria to verify data validity prior to its use. Data validation procedures have been developed by the US EPA to standardize the validation process for analytical results for both water-quality and soil-quality investigations and are documented as the *US EPA Contract Laboratory Program National Functional Guidelines for Superfund Organic Methods Data Review*, US EPA, Office of Solid Waste and Emergency Response, Washington, D.C., Publication 9240.1-48, US EPA-540/R-08-01 (US EPA 2008). The Functional Guidelines are intended to be used as a guide for evaluation of data generated under statements of work for organic and inorganic analyses associated with the US EPA Contract Laboratory Program (CLP). The Functional Guidelines also provide general data validation guidelines that can be applied to data generated by non-CLP analytical methods.

One hundred percent (100%) of the analytical data for soil and groundwater samples will be validated using EPA Stage 4 data validation level. Stage 4 validation includes an examination of sample and QC raw data and instrument printouts to check for technical, calculation, analyte identification, analyte quantitation, and transcription or reduction errors. At a minimum 10% of reported results on summary forms should be confirmed by recalculation. The data validation staff will review field documents and laboratory data report packages, and if needed, apply data qualifiers to the data. The data reviewer will determine if the project data quality objectives have been met, and will calculate the data completeness for the project.

## **9.0 QUALITY CONTROL**

This Addendum has been prepared to provide instructions and guidance to ensure the sample chemical data collected in support of the site soil and groundwater sampling results are scientifically valid. The sections below outline methods and processes to meet these objectives.

### **9.1 Field Quality Control Samples**

To evaluate quality control (QC), a blind field duplicate sample will be collected at a frequency of 5 percent of the samples for each matrix (soil and groundwater).

Two trip blank vials provided by the laboratory will be placed into the cooler designated to store samples to be analyzed for VOCs to evaluate the potential for cross-contamination. Field duplicates are replicate samples collected at the same location during the same sampling session (roughly at the same time). The field duplicate samples will be collected in the same container types and handled and analyzed in the same manner, as all other soil and groundwater samples. The field duplicates will be analyzed for the same analytes as the primary sample.

### **9.2 Laboratory Quality Control Samples**

Laboratory QC samples are analyzed as part of standard laboratory practice. The laboratory monitors the precision and accuracy of the results of its analytical procedures through analysis of QC samples. In part, laboratory QC samples consist of Matrix Spike/Matrix Spike Duplicate (MS/MSD) samples for organic analyses, and MS/MSD for inorganic analyses. The term "matrix" refers to use of the actual media collected in the field (e.g., routine soil and water samples). Laboratory QC samples are an aliquot (subset) of the field sample. They are not separate samples, but a special designation of an existing sample. The laboratory QC samples will be analyzed for the same analytes as the standard samples.

### **9.3 Field Variances**

As conditions in the field may vary, it may become necessary to implement minor modifications to the sampling as presented in this Addendum. When appropriate, ExxonMobil, ADC, and the City of Everett will be notified and a verbal (followed by a written verification) approval will be obtained before implementing the changes. Modifications to the approved plan will be documented in the sampling project report.

### **9.4 Data Management**

Data management will commence during the field investigation. Each soil and groundwater sample collected will be recorded on field logs, which will include a description of the location, depth, matrix, sample ID, and date and time of collection. All data submittals will be consistent with Ecology Policy 840 (dated March 31, 2008) Environmental Information Management (EIM) submittal requirement format. Once data have been provided by the laboratory, the electronic

deliverables will be reviewed to ensure the receipt of all requested analytes and again cross-checked with COCs.

## 10.0 REFERENCES

AMEC Earth & Environmental, Inc. (AMEC), 2009. *Draft Final Focused Feasibility Study Work Plan for ExxonMobil / ADC Property, Ecology ID 2728, 2717/2731 Federal Avenue, Everett, Washington, Bothell, Washington, October 2.*

U.S. Environmental Protection Agency (EPA), 1994. *Guidance of the Data Quality Objectives Process*, EPA QA/G-4. EPA/600/R-96/055, EPA Office of Research and Development, Washington, D.C. September.

Puls, R.W. and Barcelona, M.J., 1996. *Low-Flow (Minimal Drawdown) Groundwater Sampling Procedures*, U.S. EPA /540/S-95/504

Washington State Department of Ecology (Ecology), 2001. *Model Toxics Control Act Cleanup Regulation*, Chapter 173-340 WAC. Publication No. 94-06

## TABLES

**Table 1. Method Detection and Reporting Limits for Soil Samples**

<b>Specific Method</b>	<b>Analyte</b>	<b>MDL</b>	<b>MRL</b>	<b>Units</b>
SW846 8260B	Acetone	0.0250	0.0500	mg/kg
SW846 8260B	Benzene	0.000670	0.00200	mg/kg
SW846 8260B	Bromobenzene	0.000670	0.00200	mg/kg
SW846 8260B	Bromochloromethane	0.00102	0.00200	mg/kg
SW846 8260B	Bromodichloromethane	0.000400	0.00200	mg/kg
SW846 8260B	Bromoform	0.000670	0.00200	mg/kg
SW846 8260B	Bromomethane	0.000640	0.00200	mg/kg
SW846 8260B	2-Butanone	0.0170	0.0500	mg/kg
SW846 8260B	sec-Butylbenzene	0.000670	0.00200	mg/kg
SW846 8260B	n-Butylbenzene	0.000670	0.00200	mg/kg
SW846 8260B	tert-Butylbenzene	0.000670	0.00200	mg/kg
SW846 8260B	Carbon disulfide	0.000670	0.00500	mg/kg
SW846 8260B	Carbon Tetrachloride	0.000670	0.00200	mg/kg
SW846 8260B	Chlorobenzene	0.000670	0.00200	mg/kg
SW846 8260B	Chlorodibromomethane	0.000380	0.00200	mg/kg
SW846 8260B	Chloroethane	0.000420	0.00500	mg/kg
SW846 8260B	Chloroform	0.000670	0.00200	mg/kg
SW846 8260B	Chloromethane	0.00100	0.00200	mg/kg
SW846 8260B	2-Chlorotoluene	0.000670	0.00200	mg/kg
SW846 8260B	4-Chlorotoluene	0.000670	0.00200	mg/kg
SW846 8260B	1,2-Dibromo-3-chloropropane	0.00340	0.00500	mg/kg
SW846 8260B	1,2-Dibromoethane (EDB)	0.000520	0.00200	mg/kg
SW846 8260B	Dibromomethane	0.000670	0.00200	mg/kg
SW846 8260B	1,4-Dichlorobenzene	0.000720	0.00200	mg/kg
SW846 8260B	1,3-Dichlorobenzene	0.000430	0.00200	mg/kg
SW846 8260B	1,2-Dichlorobenzene	0.000430	0.00200	mg/kg
SW846 8260B	Dichlorodifluoromethane	0.00160	0.00200	mg/kg
SW846 8260B	1,1-Dichloroethane	0.000670	0.00200	mg/kg
SW846 8260B	1,2-Dichloroethane	0.000670	0.00200	mg/kg
SW846 8260B	cis-1,2-Dichloroethene	0.000670	0.00200	mg/kg
SW846 8260B	1,1-Dichloroethene	0.000670	0.00200	mg/kg
SW846 8260B	trans-1,2-Dichloroethene	0.000670	0.00200	mg/kg
SW846 8260B	1,3-Dichloropropane	0.000450	0.00200	mg/kg
SW846 8260B	1,2-Dichloropropane	0.000670	0.00200	mg/kg
SW846 8260B	2,2-Dichloropropane	0.000780	0.00200	mg/kg
SW846 8260B	cis-1,3-Dichloropropene	0.000670	0.00200	mg/kg
SW846 8260B	trans-1,3-Dichloropropene	0.000670	0.00200	mg/kg
SW846 8260B	1,1-Dichloropropene	0.000670	0.00200	mg/kg
SW846 8260B	Ethylbenzene	0.000670	0.00200	mg/kg
SW846 8260B	Hexachlorobutadiene	0.000630	0.00500	mg/kg
SW846 8260B	2-Hexanone	0.0170	0.0500	mg/kg
SW846 8260B	Isopropylbenzene	0.000670	0.00200	mg/kg
SW846 8260B	p-Isopropyltoluene	0.000670	0.00200	mg/kg
SW846 8260B	Methyl tert-Butyl Ether	0.000670	0.00200	mg/kg
SW846 8260B	Methylene Chloride	0.00200	0.0100	mg/kg
SW846 8260B	4-Methyl-2-pentanone	0.00290	0.0500	mg/kg
SW846 8260B	Naphthalene	0.00170	0.00500	mg/kg
SW846 8260B	n-Propylbenzene	0.000670	0.00200	mg/kg
SW846 8260B	Styrene	0.000670	0.00200	mg/kg
SW846 8260B	1,1,1,2-Tetrachloroethane	0.000670	0.00200	mg/kg
SW846 8260B	1,1,2,2-Tetrachloroethane	0.000670	0.00200	mg/kg
SW846 8260B	Tetrachloroethene	0.000400	0.00200	mg/kg
SW846 8260B	Toluene	0.000400	0.00200	mg/kg

**Table 1. Method Detection and Reporting Limits for Soil Samples**

SW846 8260B	1,2,3-Trichlorobenzene	0.000920	0.00200	mg/kg
SW846 8260B	1,2,4-Trichlorobenzene	0.00102	0.00200	mg/kg
SW846 8260B	1,1,2-Trichloroethane	0.00111	0.00500	mg/kg
SW846 8260B	1,1,1-Trichloroethane	0.000400	0.00200	mg/kg
SW846 8260B	Trichloroethene	0.000830	0.00200	mg/kg
SW846 8260B	Trichlorofluoromethane	0.000670	0.00200	mg/kg
SW846 8260B	1,2,3-Trichloropropane	0.00103	0.00200	mg/kg
SW846 8260B	1,3,5-Trimethylbenzene	0.000400	0.00200	mg/kg
SW846 8260B	1,2,4-Trimethylbenzene	0.000420	0.00200	mg/kg
SW846 8260B	Vinyl chloride	0.000820	0.00200	mg/kg
SW846 8260B	o-Xylene	0.000670	0.00200	mg/kg
SW846 8260B	m,p-Xylene	0.000670	0.00300	mg/kg
SW846 8260B	Xylenes, total	0.00130	0.00500	mg/kg
SW846 8260B	Diisopropyl Ether	0.000670	0.00200	mg/kg
SW846 8260B	1,2-Dichloroethene (total)	0.00144	0.00200	mg/kg
SW846 8260B	1,1,2-Trifluorotrchloroethane	0.000590	0.00200	mg/kg
SW846 8270D SIM	Acenaphthene	0.000300	0.00333	mg/kg
SW846 8270D SIM	Acenaphthylene	0.000400	0.00333	mg/kg
SW846 8270D SIM	Anthracene	0.000700	0.00333	mg/kg
SW846 8270D SIM	Benzo (a) anthracene	0.000300	0.00333	mg/kg
SW846 8270D SIM	Benzo (a) pyrene	0.000400	0.00333	mg/kg
SW846 8270D SIM	Benzo (b) fluoranthene	0.00160	0.00333	mg/kg
SW846 8270D SIM	Benzo (g,h,i) perylene	0.000300	0.00333	mg/kg
SW846 8270D SIM	Benzo (k) fluoranthene	0.000300	0.00333	mg/kg
SW846 8270D SIM	Chrysene	0.000600	0.00333	mg/kg
SW846 8270D SIM	Dibenz (a,h) anthracene	0.000400	0.00333	mg/kg
SW846 8270D SIM	Fluoranthene	0.000400	0.00333	mg/kg
SW846 8270D SIM	Fluorene	0.000500	0.00333	mg/kg
SW846 8270D SIM	Indeno (1,2,3-cd) pyrene	0.000300	0.00333	mg/kg
SW846 8270D SIM	1-Methylnaphthalene	0.000400	0.00333	mg/kg
SW846 8270D SIM	2-Methylnaphthalene	0.000400	0.00333	mg/kg
SW846 8270D SIM	Naphthalene	0.000700	0.00333	mg/kg
SW846 8270D SIM	Phenanthrene	0.000400	0.00333	mg/kg
SW846 8270D SIM	Pyrene	0.000300	0.00333	mg/kg
NWTPH-Dx	TPH - Diesel Range by NWTPH-Dx (SGT)	2.00	4.00	mg/kg
NWTPH-Dx	TPH - Oil Range by NWTPH-Dx (SGT)	2.00	4.00	mg/kg
NWTPH-Gx	TPH - NWTPH-Gx	0.500	5.00	mg/kg
SW846 1311/6010B	Arsenic TCLP SW 6010B	0.0400	0.100	mg/L
SW846 1311/6010B	Barium TCLP SW 6010B	0.0100	0.100	mg/L
SW846 1311/6010B	Cadmium TCLP SW 6010B	0.00600	0.0100	mg/L
SW846 1311/6010B	Chromium TCLP SW 6010B	0.0260	0.0500	mg/L
SW846 1311/6010B	Lead TCLP SW 6010B	0.0210	0.0500	mg/L
SW846 1311/6010B	Selenium TCLP SW 6010B	0.0390	0.100	mg/L
SW846 1311/6010B	Silver TCLP SW 6010B	0.0280	0.0500	mg/L
SW846 1311/7470A	Mercury TCLP 7470A	0.00100	0.0100	mg/L
SW846 6010B	Arsenic Total EPA 6010B	0.700	1.00	mg/kg
SW846 6010B	Barium Total EPA 6010B	0.100	2.00	mg/kg
SW846 6010B	Cadmium Total EPA 6010B	0.200	1.00	mg/kg
SW846 6010B	Chromium Total EPA 6010B	0.500	1.00	mg/kg

**Table 1. Method Detection and Reporting Limits for Soil Samples**

SW846 6010B	Lead Total EPA 6010B	0.400	1.00	mg/kg
SW846 6010B	Selenium Total EPA 6010B	0.700	2.00	mg/kg
SW846 6010B	Silver Total EPA 6010B	0.500	1.00	mg/kg
SW846 7471A	Mercury 7471A	0.0400	0.100	mg/kg
SW846 7196A	Chromium, Hexavalent by EPA 7196A	1.70	2.00	mg/kg

Notes:

- TPH = Total Petroleum Hydrocarbon
- EPA = U. S. Environmental Protection Agency
- mg/kg = milligram per kilogram
- mg/L = milligram per liter
- MDL = method detection limit
- MRL = method reporting limit



**Table 2. Method Detection and Reporting Limits for Groundwater Samples**

<b>Specific Method</b>	<b>Analyte</b>	<b>MDL</b>	<b>MRL</b>	<b>Units</b>
SW846 8260B	Benzene	0.410	1.00	ug/L
SW846 8260B	Ethylbenzene	0.350	1.00	ug/L
SW846 8260B	Toluene	0.350	1.00	ug/L
SW846 8260B	o-Xylene	0.330	1.00	ug/L
SW846 8260B	m,p-Xylene	0.400	2.00	ug/L
NWTPH-Dx	Diesel	28.0	100	ug/L
NWTPH-Dx	Motor Oil	28.0	100	ug/L
NWTPH-Gx	GRO (C4-C12) NW	40.0	100	ug/L
SW846 6010B	Arsenic Total EPA 6010B	0.00360	0.0100	mg/L
SW846 6010B	Barium Total EPA 6010B	0.00100	0.0100	mg/L
SW846 6010B	Cadmium Total EPA 6010B	0.000600	0.00100	mg/L
SW846 6010B	Chromium Total EPA 6010B	0.00260	0.00500	mg/L
SW846 6010B	Lead Total EPA 6010B	0.00210	0.00500	mg/L
SW846 6010B	Selenium Total EPA 6010B	0.00390	0.0100	mg/L
SW846 6010B	Zinc Total EPA 6010B	0.00500	0.0500	mg/L
SW846 7470A	Mercury Total 7470A	0.000100	0.000200	mg/L

Notes:

TPH = Total Petroleum Hydrocarbon

EPA = U. S. Environmental Protection Agency

mg/L = milligram per liter

µ/L = microgram per liter

MDL = method detection limit

MRL = method reporting limit

**Table 3 Soil and Groundwater Samples**

<b>Boring Number</b>	<b>City of Everett Trench Station Number</b>	<b>Trench Depth (ft bgs)</b>	<b>Drilling Method</b>	<b>Boring Depth (ft bgs)</b>	<b>Depth of Sampling (ft bgs)</b>	<b>Number of Soil Samples</b>	<b>Number of Groundwater Samples</b>
CE-1	20+02	7.9	HSA	8	8	2	1
CE-2	18+00	7.5	HSA	20	8	3	1
CE-3	17+00	7.6	HSA	8	8	2	1
CE-4	15+50	6.75	HSA	7	7	2	1
CE-5	14+00	8	HSA	20	8	2	1
Duplicate samples						2	1
<b>Total Samples</b>						13	6

Notes:

Duplicate samples will be collected from intervals exhibiting evidence of potential contamination, such as staining or odor.

ft bgs = feet below ground surface

HSA = hollow-stem auger

**Table 4 Sample Containers, Preservation and Storage**

Analysis	Method	Sample Container	Number of Containers	Preservation and Storage	Holding Times
<b>Soil</b>					
Gasoline Range Organics	NWTPH-Gx	40-mL vial (VOA) w/MeOH	1	4° C	14 days
Diesel Range Organics <sup>1</sup>	NWTPH-Dx	4 oz. CWM jar with PTFE lid	1	4° C	14 days
Volatile Organic Compounds	EPA 8260B	40-mL vial (VOA) w/stir bar <sup>2</sup>	2	4° C	14 days
Polycyclic Aromatic Hydrocarbons	EPA 8270D	4 oz. CWM jar with PTFE lid	1	4° C	14 days
Metals	EPA 6010/6020	4 oz. CWM jar with PTFE lid	1	4° C	6 months
Mercury (Hg)/Hexavalent Chromium (CrVI)	EPA 7471/7196	4 oz. CWM jar with PTFE lid	1	4° C	28 days
<b>Water</b>					
Gasoline Range Organics	NWTPH-Gx	40-mL vial (VOA) w/HCl	1	HCl pH<2, 4° C	14 days
Diesel Range Organics <sup>1</sup>	NWTPH-Dx	4 oz. CWM jar with PTFE lid	1	4° C	14 days
BTEX	EPA 8260B	40-mL vial (VOA) w/HCl	2	4° C	14 days
Metals (total)	EPA 200.7/200.8	500-mL HDPE	1	HNO <sub>3</sub> pH<2, 4° C	6 months
Mercury (Hg)	EPA 7470	500-mL HDPE	1	4° C	28 days
pH	EPA 150.1/9040	60-mL HDPE	1	4° C	ASAP

Notes:

1. Silica gel cleanup will be performed on samples
  2. Sample volume = 5 ounces
- NW TPH = Northwest Total Petroleum Hydrocarbon  
 EPA = U. S. Environmental Protection Agency  
 CWM jar = Clear, wide-mouth glass jar  
 HCl = Hydrochloric acid  
 MeOH = Methanol  
 BTEX = benzene, toluene, ethylbenzene, total xylene  
 NaOH = sodium hydroxide  
 HNO<sub>3</sub> = Nitric Acid  
 HDPE - High Density Polyethylene  
 PTFE = teflon  
 VOA = volatile organic analysis  
 mL = milliliter

## FIGURES

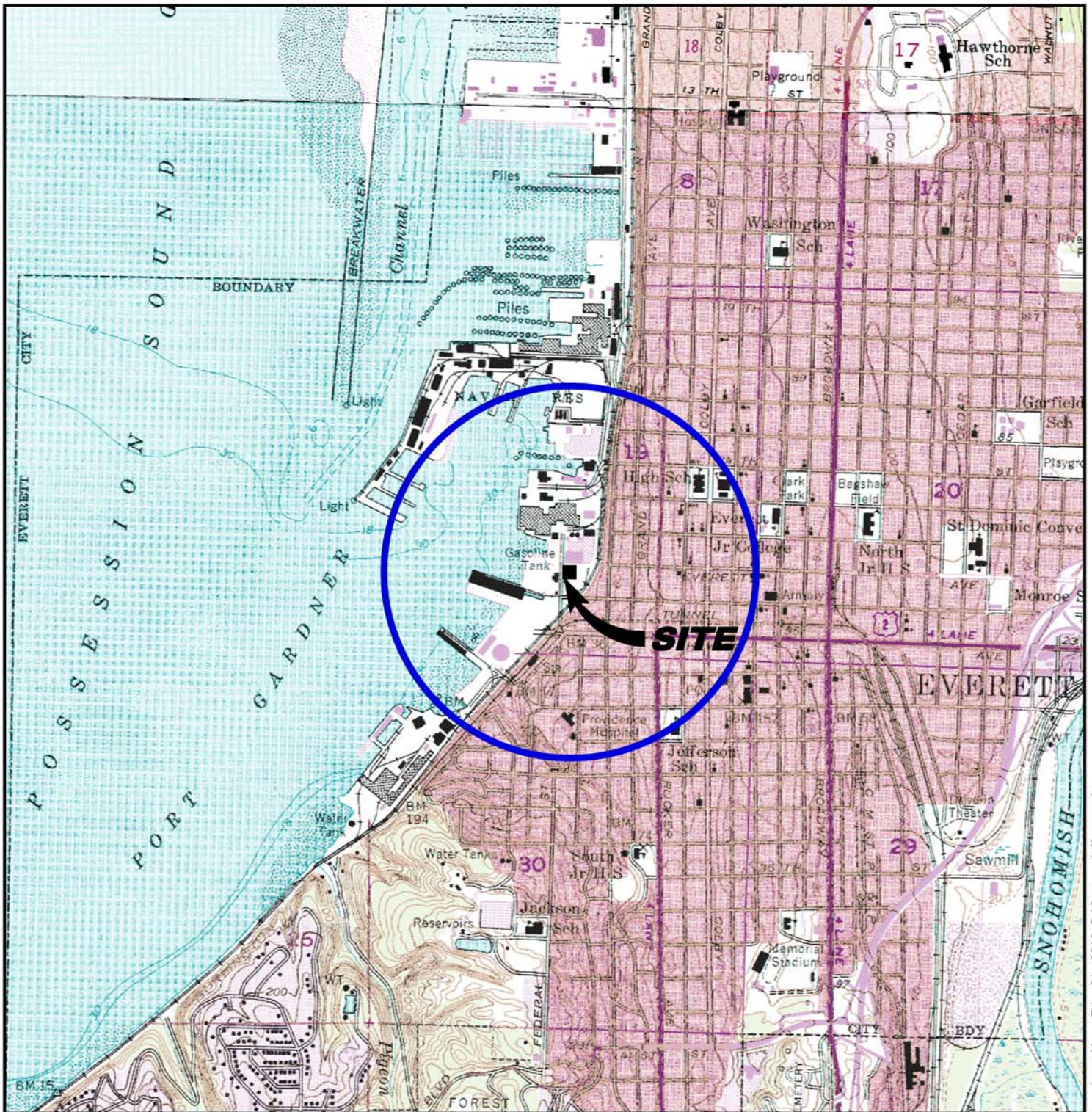

**EXPLANATION**



1/2-MILE RADIUS CIRCLE

SOURCE: USGS Quad Topo of Everett and Marysville, Photorevised 1973.



0 2000 4000 Feet

SCALE: 1:24,000

**AMEC Earth & Environmental**

11810 North Creek Parkway North  
Bothell, WA, U.S.A. 98011-8201



CLIENT LOGO

CLIENT

**EXXONMOBIL AND  
AMERICAN DISTRIBUTING COMPANY**

PROJECT **EXXONMOBIL/ADC PROPERTY, ECOLOGY SITE ID 2728**

DWN BY: JRS

DATUM: NONE

DATE: FEBRUARY 2010

TITLE **SITE LOCATION MAP**

CHK'D BY: AS

REV. NO.:

PROJECT NO:  
0-915-15716-D

PROJECTION:  
NONE

SCALE:  
AS SHOWN

FIGURE No.  
**1**

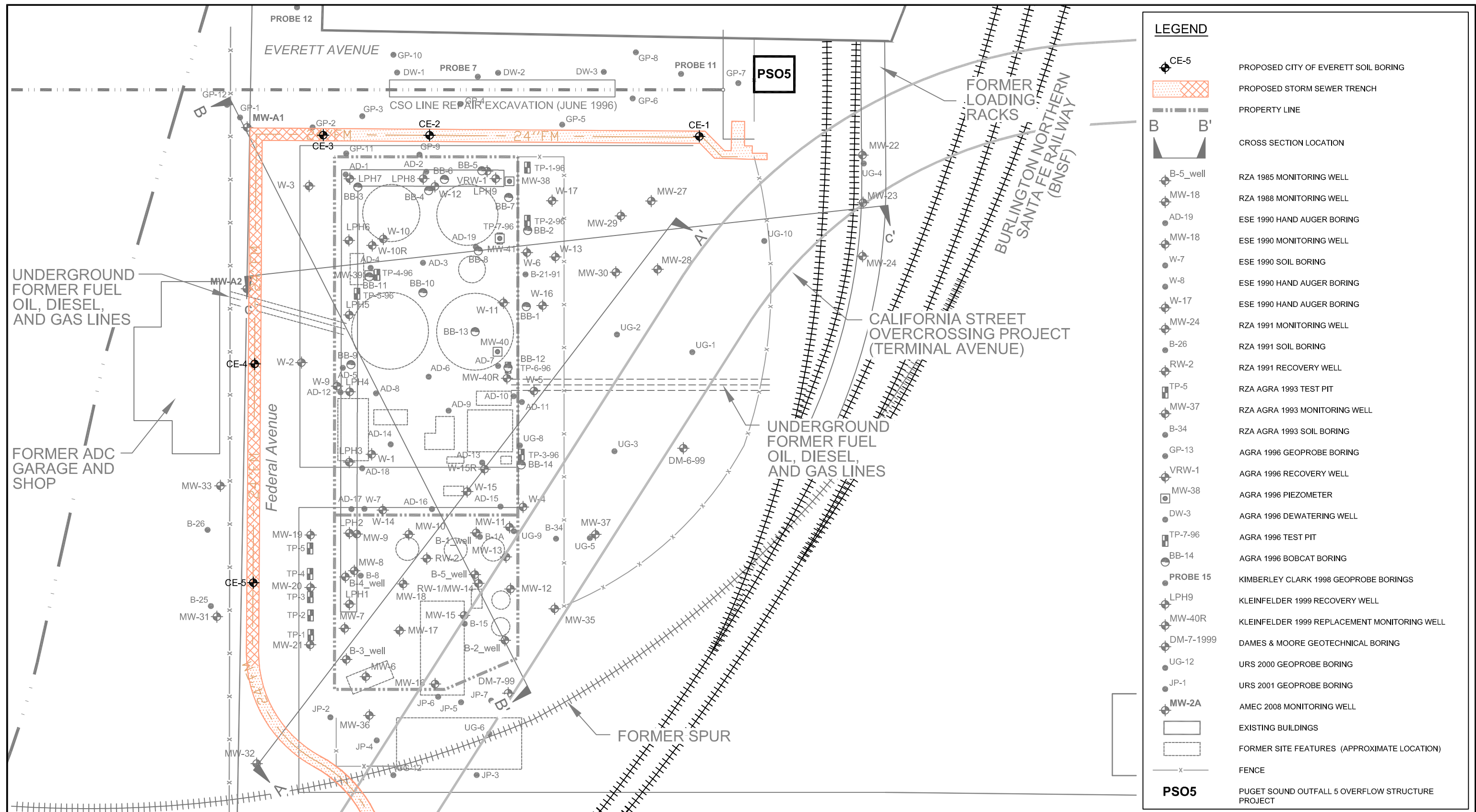

LEGEND	
	PROPOSED CITY OF EVERETT SOIL BORING
	PROPOSED STORM SEWER TRENCH
	PROPERTY LINE
	CROSS SECTION LOCATION
	RZA 1985 MONITORING WELL
	RZA 1988 MONITORING WELL
	ESE 1990 HAND AUGER BORING
	ESE 1990 MONITORING WELL
	ESE 1990 SOIL BORING
	ESE 1990 HAND AUGER BORING
	ESE 1990 HAND AUGER BORING
	RZA 1991 MONITORING WELL
	RZA 1991 SOIL BORING
	RZA 1991 RECOVERY WELL
	RZA AGRA 1993 TEST PIT
	RZA AGRA 1993 MONITORING WELL
	RZA AGRA 1993 SOIL BORING
	AGRA 1996 GEOPROBE BORING
	AGRA 1996 RECOVERY WELL
	AGRA 1996 PIEZOMETER
	AGRA 1996 DEWATERING WELL
	AGRA 1996 TEST PIT
	AGRA 1996 BOBCAT BORING
	KIMBERLEY CLARK 1998 GEOPROBE BORINGS
	KLEINFELDER 1999 RECOVERY WELL
	KLEINFELDER 1999 REPLACEMENT MONITORING WELL
	DAMES & MOORE GEOTECHNICAL BORING
	URS 2000 GEOPROBE BORING
	URS 2001 GEOPROBE BORING
	AMEC 2008 MONITORING WELL
	EXISTING BUILDINGS
	FORMER SITE FEATURES (APPROXIMATE LOCATION)
	FENCE
	PUGET SOUND OUTFALL 5 OVERFLOW STRUCTURE PROJECT

SOURCE: Modified from a map provided by City of Everett, ExxonMobil Oil Corporation and Environmental Resolution, Inc.

CLIENT LOGO

CLIENT:

**EXXONMOBIL AND AMERICAN DISTRIBUTING COMPANY**

AMEC Earth & Environmental  
11810 North Creek Parkway North  
Bothell, WA, U.S.A. 98011-8201

DWN BY: JRS / BRJ  
CHK'D BY: AS/MS  
DATUM: NONE  
PROJECTION: NONE  
SCALE: 1" = 60'

PROJECT: EXXONMOBIL/ADC PROPERTY  
ECOLOGY SITE ID 2728

TITLE: PROPOSED STORM SEWER UPGRADE  
SOIL BORINGS

DATE: FEBRUARY 2010  
PROJECT NO: 0-915-15716-D  
REV. NO.: 1  
FIGURE No. 2

0 60 120  
SCALE IN FEET

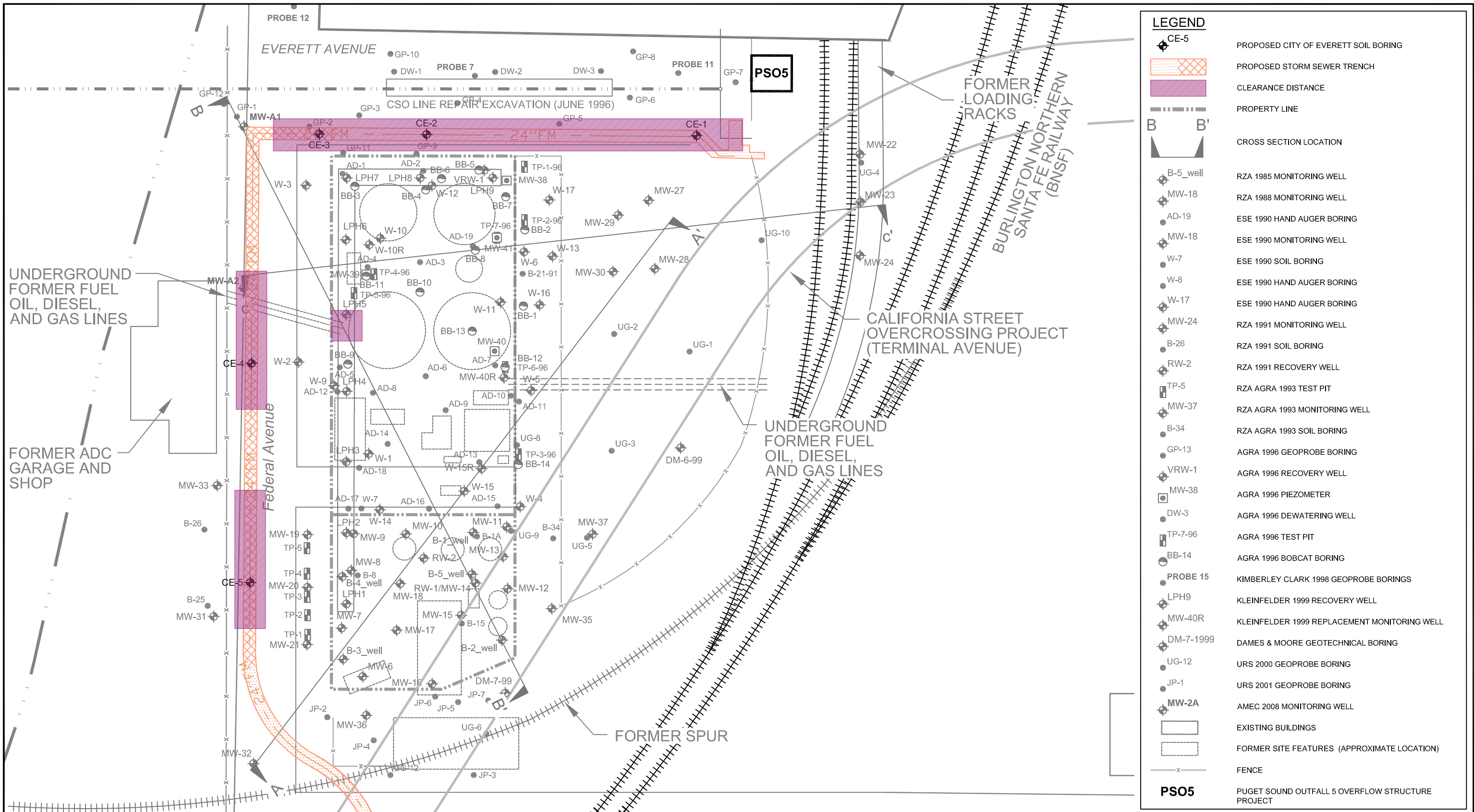

SOURCE: Modified from a map provided by City of Everett, ExxonMobil Oil Corporation and Environmental Resolution, Inc.

CLIENT LOGO

CLIENT:  
**EXXONMOBIL AND AMERICAN DISTRIBUTING COMPANY**

**AMEC Earth & Environmental**  
 11810 North Creek Parkway North  
 Bothell, WA, U.S.A. 98011-8201



DWN BY: JRS / BRJ  
 CHK'D BY: AS/MS  
 DATUM: NONE  
 PROJECTION: NONE  
 SCALE: 1" = 60'

PROJECT  
**EXXONMOBIL/ADC PROPERTY**  
 ECOLOGY SITE ID 2728

TITLE  
**CLEARANCE DISTANCE IN VICINITY OF PROPOSED BORINGS**

DATE: FEBRUARY 2010  
 PROJECT NO: 0-915-15716-D  
 REV. NO.: 1  
 FIGURE No. 3

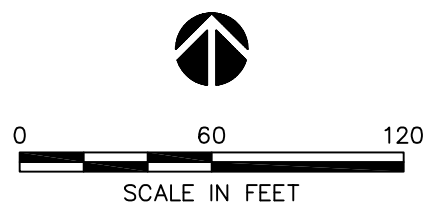

## **ATTACHMENT A1**

Boring Logs for MW-A1 and MW-A2



DEPTH (ft bgs)	GRAPHIC LOG	USCS SYMBOL	SOIL DESCRIPTION	SAMPLE	BLOW COUNT SPT N VALUE	VOLATILE READING (ppm)	GROUNDWATER	FIELD AND LABORATORY TESTING	WELL SCHEMATIC
0			Surface: 0.2 feet of asphalt over 1.6 feet of gray fine to medium angular moist, (crushed rock base course) A vac-truck was utilized from 0 to 5 feet below the ground surface to ensure utilities were cleared.						Flush mount in cement seal  Hydrated bentonite chip seal
5		SP SM	Medium dense, moist, brown, fine to coarse SAND with some silt and trace fine gravel Moist to wet, wood; possibly a large block		22	0.0			2-inch PVC casing in 2/12 silica sand filter pack 2-inch PVC 10 slot screen in 2/12 silica sand filter pack
		SP	Loose, wet, brown, fine to medium SAND with trace silt and petroleum odor  Becomes saturated and gray at 8.3 feet Water appeared viscous and sediments appeared to have a metallic luster from 8.3 to 9 feet Becomes medium dense at 9.5 feet		6	0.0	▼	A1_S-1_020408 Sheen Test None Observed A1_S-2_020408	
10			Becomes gray and brown, with some fine gravel and trace silt and no odor observed at 10.4 feet Cobbles in sampler shoe		21	0.0			
		GP- GM SP	Medium dense, saturated, dark gray, fine GRAVEL with some fine to medium sand and silt, light to medium sheen Medium dense, saturated, gray fine to medium SAND with trace silt and fine gravel and occasional organics (wood splinters) Approximatley 0.01 foot thick layers of wood splinters at 13, 14, and 15 feet Becomes loose, with petroleum odor and no visible gravel at 14.5 feet		16	0.0		Sheen Test Light Observed	
15			Becomes loose, with petroleum odor and no visible gravel at 14.5 feet		14	0.0			2/12 silica sand Bentonite chips
			Approximatley 0.1 foot thick layer of stiff, moist, brown, SILT with numerous organics / organic SILT (plant fragments, wood fibers, roots) at 18 feet		14	0.0		Sheen Test Light Observed	
20					24	0.0		Sheen Test None Observed	
		ML	Very stiff, moist, brown, SILT with trace fine to coarse sand and numerous organics / organic SILT with trace fine to coarse sand		20	0.0			
25		SP	Becomes with occasional organics (roots) at 25 feet Medium dense, saturated, gray, fine to medium SAND with trace silt		17	0.0			
30			Exploration terminated at 26.5 feet below the existing ground surface.						

BORING METHOD: HSA

ELEVATION REFERENCE: NA

BOREHOLE DIAMETER: 8 (in)

GROUND SURFACE ELEVATION: NA

DRILL RIG: CME

CASING ELEVATION: NA

CONTRACTOR: Cascade Drilling, Inc./Scott

START CARD/TAG ID: /BAB238

LOGGED BY: LME

DRILLING DATES: 02/04/2008 - 02/04/2008

REMARKS:

ENVR+WELL-BORING FEDERAL AVENUE.GPJ AMEC PORTLAND.GDT 3/17/08

**ExxonMobil / American Distributing Company**

**7-915-15716-B**

AMEC Earth and Environmental, Inc.  
11335 NE 122nd Way, Suite 100  
Kirkland, Washington  
USA 98034  
Tel (425) 820-4669  
Fax (425) 821-3914



**LOG OF BORING  
MWA1**

PAGE 1 OF 1

0 DEPTH (ft bgs)	GRAPHIC LOG	USCS SYMBOL	SOIL DESCRIPTION	SAMPLE	BLOW COUNT SPT N VALUE	VOLATILE READING (ppm)	GROUNDWATER	FIELD AND LABORATORY TESTING	WELL SCHEMATIC
0			Surface: moist, dark gray, angular fine to medium gravel (crushed rock) A vac-truck was utilized from 0 to 5 feet below the ground surface to ensure utilities were cleared.  Approximatley 2 feet of wood with creosote odor (appeared to be blocks of wood treated with creosote)						Flush mount in cement seal  Hydrated bentonite chip seal
5		SP	Very loose, moist, black, fine to medium SAND with some silt and numerous organics (wood splinters)		5	0.0	▼	A2_S-1_020408 Sheen Test Light	2-inch PVC casing in 2/12 silica sand filter pack 2-inch PVC 10 slot screen in 2/12 silica sand filter pack
		SP	Very loose, moist, brown, fine to medium SAND with trace silt					Observed A2_S-2_020408	
		ML	Stiff, wet to saturated, blue-gray, sandy SILT with slight petroleum odor and light sheen						
		OL/ML	Stiff, moist, dark brown to black, organic SILT / SILT with numerous organics (roots, plant fragments) and petroleum odor		11	0.0	▼		
		SM	Loose, wet to saturated, silty, fine to medium SAND with trace fine gravel and petroleum odor and light sheen						
		ML	Stiff, moist, brown, SILT with some clay and numerous organics (roots)		25	0.0		Sheen Test None Observed	
10		SP	Loose, moist to wet, gray, fine to medium SAND with trace silt and scattered organics (roots)						
		SP	Medium dense, saturated, gray, fine to medium SAND with trace silt		17	0.0			
15			Becomes with occasional organics (roots, plant fragments) at 15 feet  Tip of sampler shoe contained wet, brown, organic SILT / SILT with numerous organics (roots, plant fragments)		11	0.0		Sheen Test None Observed	2/12 silica sand Bentonite chips
					14	0.0			
20					16	0.0		Sheen Test None Observed	
		OL/ML	Stiff, moist, brown, organic stratified SILT with some clay and trace fine to medium sand / stratified SILT with some clay and trace fine to medium sand and numerous organics (roots, plant fragments)						
		SP	Medium dense, saturated, gray, fine to medium SAND with trace silt and occasional organics (roots, plant fragments) Becomes no visible organics at 22 feet		25	0.0			
25					25	0.0		Sheen Test None Observed	
30			Exploration terminated at 26.5 feet below the existing ground surface.						

BORING METHOD: HSA	ELEVATION REFERENCE: NA	REMARKS:
BOREHOLE DIAMETER: 8 (in)	GROUND SURFACE ELEVATION: NA	
DRILL RIG: CME	CASING ELEVATION: NA	
CONTRACTOR: Cascade Drilling, Inc./Scott	START CARD/TAG ID: /BAB237	
LOGGED BY: LME	DRILLING DATES: 02/04/2008 - 02/04/2008	

ENVR+WELL-BORING FEDERAL AVENUE GPJ AMEC PORTLAND.GDT 3/17/08

**ExxonMobil / American Distributing Company**  
7-915-15716-B

AMEC Earth and Environmental, Inc.  
11335 NE 122nd Way, Suite 100  
Kirkland, Washington  
USA 98034  
Tel (425) 820-4669  
Fax (425) 821-3914



**LOG OF BORING MWA2**  
PAGE 1 OF 1

## **ATTACHMENT A2**

Site-Specific Health and Safety Plan

**SITE SPECIFIC HEALTH AND SAFETY PLAN**

Project Name: ExxonMobil/ADC Property, Ecology Site ID 2728  
Project Location: 2717/2731 Federal Avenue, Everett, Washington  
Project Number: 9-91-51571-6C

**THIS SITE SPECIFIC HEALTH AND SAFETY PLAN APPLIES ONLY TO AMEC PERSONNEL.**

**All site personnel must have completed the 8-hour ExxonMobil LPS Training prior to undertaking any field work at the site.**

**A PRE-ENTRY BRIEFING MUST BE HELD PRIOR TO INITIATING ANY SITE ACTIVITY AND AT OTHER TIMES AS NECESSARY TO ENSURE EMPLOYEES ARE APPRAISED OF THE SITE HEALTH AND SAFETY PLAN.**

**SAFETY PERSONNEL:**

Health and Safety Coordinators: Leah Vigoren and Anastasia Speransky  
Project Engineers: Leah Vigoren  
Project Managers: Meg Strong and Gary Dupuy  
Site Safety Coordinator (SSC): Leah Vigoren  
Client Contact: Joe Abel: ExxonMobil Environmental Services (EMES)

**EMERGENCY CONTACTS:**

Hospital / Emergency Room: **Providence Medical Center** **425-258-7555**

**Map showing shortest route to Hospital is attached to this document.**

Fire: 911  
Police: 911  
Poison Control Center: 1-800-222-1222  
Emergency Water Shut-off: Everett 1-425-257-8821  
Electric Utility: Snohomish County PUD 1-877-783-1000  
Washington State Patrol: 911

Health and Safety Coordinator: Leah Vigoren (Cell Phone: 206-351-9449) 206-342-1760 (w)  
Project Manager: Meg Strong (Cell Phone: 425-864-2096) 425-368-0966 (w)

AMEC Earth & Environmental, Inc.  
11810 North Creek Parkway  
Bothell, Washington  
USA 98011  
(425) 368-1000 Phone  
(425) 368-1001 Facsimile

## **SITE HISTORY**

The approximate 1-acre site was purchased by ExxonMobil's historic predecessors in 1922, and was utilized as a petroleum bulk storage distribution facility between 1922 and 1974. In 1974, the then Mobile Company sold two thirds of the site (northern portion) to A.P. Miller (Miller), for use by the American Distributing Company (ADC). In 1987, Mobile discontinued petroleum storage and dispensing operations on their portion of the site and removed all storage tanks and ancillary equipment. In 1990, petroleum distribution was discontinued on the ADC parcel, and some improvements and tanks were removed from the parcel. Since then, the site has been turned into a parking lot and is leased to the Kimberly Clark facility located to the north of the site. Activities that have occurred on the site since this time have been environmental investigations and remedial activities to address petroleum impacts to soil and groundwater.

In 1985, site characterization activities were initiated to define the nature and extent of petroleum impacts beneath the site. Between 1988 and 1996, a variety of Interim Remedial Action Measures (IRAMs) were implemented to address the free product. In 1998, a Remedial Investigation/Focused Feasibility Study (RI/FFS) was performed in coordination of the Washington State Department of Ecology (Ecology) under the Consent Order. Remedial Action Objectives (RAOs) were developed for the site based on the RI data and baseline human health risk assessment. The remedy selected to achieve RAOs included the following.

- 1) Construction of an interceptor trench along the down gradient margins of the site (entire western and northern boundaries) to mitigate the off-site migration of the light non-aqueous phase liquid (LNAPL) present on the shallow water table.
- 2) Placement of low-permeability cap across the entire site surface
- 3) Ongoing removal and disposal of recovered LNAPL from site monitoring wells and interceptor trench; and
- 4) Quarterly groundwater monitoring.

In addition, the City of Everett is planning to upgrade the storm sewer line that will result in trenching within Everett Avenue and Federal Avenue. In advance of trenching, samples of the soil and groundwater will be collected from borings to determine soil and groundwater disposal options. This HASP addresses the specific field sampling activities related to the advancement of the soil borings and soil and groundwater sampling.

## **ORGANIZATIONAL STRUCTURE**

### **Project Manager(s):**

Gary Dupuy (phone number 206-342-1777) and Meg Strong (phone number 425-368-0966) are the client managers for the project. Responsibilities include remaining in contact with regulatory agencies such as the Department of Ecology, overseeing the Project and ensuring client satisfaction from commencement to closeout.

### **Site Safety and Health Supervisor:**

Leah Vigoren (phone number 206-838-8470) is the Project Manager and Health and Safety Coordinators (HSC). Primarily the duties of the HSC entail coordination with the Project Manager for preparation of site health and safety plans, assessment of chemical hazards and selection of safety / monitoring equipment.

Anastasia Speransky (phone number 206-838-1776) is the field geologist and is the Site Safety Coordinator (SSC). The SSC has the responsibility of implementing the Site Health and Safety Plan while at the Site. The SSC / HSC will be involved with the Project Manager in preparation of the Site Health and Safety Plan. If the plan is not being implemented or if unanticipated situations arise, the SSC / HSC may stop all proceedings and see that all personnel depart the site. The SSC / HSC will have charge of all instruments and see to their proper use and function.

**Field Technicians:**

Joseph C. Petrick is the Field Technician whose responsibilities include collecting soil and groundwater samples, keeping field records (I.e. Daily Field Logs) describing field activities, observations and site events. Supplying daily reports and reporting all incidents to the Project Engineer.

**Subcontractor**

Drilling company "Cascade Drilling, Inc." is responsible for the advancement of soil borings on the site.

**ON SITE TASKS**

Soil and groundwater will be characterized beneath Everett Avenue and Federal Avenue for disposal classification. Elements of this addendum are based on the Washington Administrative Code (WAC) Ecology Model Toxics Control Act (MTCA) Cleanup Regulations WAC 173-340-820 and City of Everett Waste Water discharge regulations.

The soil and groundwater sampling will include the following activities:

1. Advance five borings (three along Everett Avenue and two along Federal Avenue [Figure 2]) to evaluate the concentration of chemicals in soil and groundwater. The borings will be advanced at each location using a hollow stem auger (HSA) drill rig to the total depth of the proposed trench at the location of each boring. Two of the borings will be terminated at a minimum depth of 20 feet below ground surface (bgs) to provide soil lithology information for the City's geotechnical engineer.
2. Collect continuous samples from the borings using a standard penetration test (SPT) and a split spoon (SS).
3. Collect two to three composite soil samples from each boring for laboratory analyses. The first composite will be from the top four feet and the second from the lower four feet. Discreet samples for volatile organic compounds (VOC) analysis will be collected from the upper four feet and at regular intervals to the base of the boring. In areas where heavy contamination such as free product is observed a separate sample will be collected.
4. Collect "grab" water samples from each boring. If sheen or product is encountered, an additional water sample will be collected from just below the water table (a foot or two below).
5. Soil samples will be analyzed for CEMEX acceptance criteria and "grab" groundwater samples will be analyzed for the City of Everett sanitary sewer discharge criteria. The soil and groundwater samples will be performed on a one-week turn-around schedule.

**SAFETY & HEALTH HAZARDS ANALYSIS**

---

**a) Physical Hazards**

Physical hazards that may be encountered during site activities include noise, manual lifting, powerful moving parts and weather related hazards (cold, heat stress, wind). Hard hats, safety glasses, hearing protection and steel-toed boots will be required for all personnel working in the vicinity of heavy equipment.

Identified hazards may be mitigated by using safe work practices at all times. The SSC has total responsibility for ensuring that all AMEC personnel on-site perform work tasks in a safe and sensible manner. If at any time the SSC determines that safe work practices are not followed, the tasks will be suspended and corrective actions will be taken.

Because of the potential of explosion hazard presented during groundwater monitoring (i.e., W-2) **SMOKING WILL NOT BE ALLOWED WITHIN 50 FEET OF THE WORK ZONE.**

The following are all additional site related hazards:

- 1) **Traffic**
  - a. Cones will be set out around the work area and safety reflective vests will be worn.
  - b. All drilling will be conducted with the traffic control.
- 2) **Personnel or property damage from vehicle movement.**
  - a. When moving vehicles the following precautions must be taken
  - b. Equipment must be stowed and secured
  - c. A spotter must be used due to the presence of blind spots in the driver's field of vision.
  - d. The spotter must identify any surface obstruction / anomalies
  - e. Audible warning signals and hand signals must be used.
  - f. Operator must yield to pedestrians.
- 3) **Personal injury from handling heavy objects.**
  - a. Use proper lifting techniques; keeping back straight and lift with arms and legs; keep load near body; avoid reaching.
  - b. Do not attempting to lift anything that weighs more than 60 pounds.
  - c. Use mechanical equipment such as a cart to carry / lift large, heavy or awkward loads.
- 4) **Slips, trips and falls.**
  - a. Scan area prior to start of work.
  - b. Group all equipment and waste in one designated area.
  - c. Return tools not in use to storage.
- 5) **Pinch points on drum and well covers.**
  - a. Personnel will wear leather gloves when working with well and drum covers.
- 6) **Broken Glassware**
  - a. Personnel will use bubble wrap and blue ice when transporting samples in glass containers.
  - b. Personnel will not overtighten caps on glass bottles.

#### b) Chemical Hazards

Chemical hazards that could possibly be encountered include Gasoline, BTEX, hydrogen sulfide (H<sub>2</sub>S), and methane (CH<sub>4</sub>). The nature of this project precludes continuous exposure to any potential contaminant.

**Per past anecdotal evidence, monitoring well (MW) 30 occasionally has contained small amounts of hydrogen sulfide gas. In addition, during installation, well (W) 2 contained methane gas exceeding the lower explosive limit (LEL).** AMEC will conduct air monitoring using a photoionization detector (PID) during drilling and sampling.

- 1) **Personal Injury from chemical contact / exposure / inhalation.**
  - a. Inspect soil cuttings before handling with PID.
  - b. AMEC personnel will place themselves upwind during drilling.

#### c) Biological Hazards

The project site is a flat graded parking lot which eliminates biological hazards.

## **TRAINING**

All AMEC personnel will review the site specific Health and Safety plan before accessing the site. Personnel onsite will also have current 40-Hour Hazardous Waste Operations and Emergency Response (HAZWOPER) Certification.

Certificates of HAZWOPER completion will be maintained at the Bothell office and will be available to regulatory personnel upon request. All Personnel shall carry current 40-hour HAZWOPER training cards or appropriate paperwork while working onsite. The SSC / HSC shall be first aid and CPR trained.

In addition all site personnel must have completed the **8 hour ExxonMobil LPS Training** prior to undertaking any field work.

## **PERSONAL PROTECTIVE EQUIPMENT (PPE)**

AMEC will wear Level D PPE which consists of steel-toed, chemical resistant rubber boots, inner glove of PVC or latex, outer gloves of Nitrile or equivalent, safety glasses, Tyvek coveralls, and a hard hat. During construction activities, minimal PPE hearing protection will consist of soft foam ear-bud style plugs.

## **MEDICAL SURVEILLANCE**

---

Evidence of a current physical examination in the form of a letter from an examining physician will be maintained at the Bothell office and will be available to regulatory personnel upon request.

### **Air Monitoring**

Air monitoring will be conducted during drilling and soil sampling activities. AMEC will conduct initial air monitoring using a photoionization detector (PID). PID utilizes ultraviolet light to ionize gas molecules and is commonly employed in the detection of volatile organic compounds (VOCs). AMEC will ensure that the concentrations of VOCs are less than 5 parts per million (ppm) in breathing zone prior to proceeding with sampling. Each well will be continuously monitored during sampling. The PID will alarm if VOC concentrations exceed the levels required for breathing.

AMEC will calibrate the PID both pre and post site visits using Isobutylene calibration gas with compatible regulator.

### **Decontamination**

Disposable PPE will be stored in a secured 55-gallon drum onsite. A certified waste transporter and disposal company will be contacted to transport the drum for disposal in accordance with local, State, and Federal regulations at an offsite facility.

### **Site Control**

AMEC personnel will be provided with a site map and be required to review the Health and Safety plan prior to entry into the site. A copy of this HASP shall be on hand at all times with emergency contact numbers and directions to the nearest medical facilities easily accessible. When necessary, cones, caution tape or a suitable alternative will be used to deny public access to the work area. Cones will also be used to define an exclusion zone redirecting motorists and pedestrians away from the work area.

In all emergencies AMEC is to document the action taken and notify the HSC, Project Manager and client official of the event and subsequent response.



**In the Event of an Injury**

If an injury is life-threatening, follow steps 1 through 8 below. If the injury is not life threatening, perform necessary first aid and consider the need for decontamination prior to transport. The SSC shall be first aid and CPR trained.

- 1) Perform first aid necessary to determine victim(s) medical status
- 2) Call emergency transport.
- 3) Give specific directions to location of emergency
- 4) Give phone from which you are calling;
- 5) Tell emergency services what happened. Inform that victim(s) may be wearing contaminated clothing.
- 6) Inform emergency services how many persons need help.
- 7) Inform emergency services what is being done for the victim(s)
- 8) Stay on telephone until told to hang up.

Transport to hospital, if possible.

**Work Permits**

Copies of the permits will be available onsite during drilling activities. Cascade Drilling will obtain start cards required for drilling from the Washington State Department of Ecology.

**Security**

No unauthorized persons will be allowed in the work zone. Unauthorized persons are those without appropriate training, without proof of medical surveillance, and those with no business on the site.

**Confined Space Entry Procedures**

AMEC will not be entering confined spaces at the Site.

**Spill Containment Program**

The site specific accidental spill / release action plan consists of the following:

- 1) Pick up, isolate, or contain spill;
- 2) Evacuate area, if necessary;
- 3) Contact emergency agencies, if necessary.

**Incident Reporting Requirements**

In all emergencies, document action taken and notify the HSC / SSC, Project Manager and client officials of occurrences.

AMEC will report all incidents and Near Loss Incidents (NLI) to the ExxonMobil contact within 24 hours of the occurrence along with a written report and the launching of an accident investigation.



# EMERGENCY MEDICAL ROUTE DIRECTIONS

2717 Federal Avenue, Everett, WA 98201

1. Head south on Federal Avenue towards Terminal Avenue.
2. Turn left at Terminal Avenue.
3. Continue on Everett Avenue/WA-529.
4. Turn left on Grand Avenue.
5. Turn right at 14th Street.
6. Turn left at Colby Avenue.

1321 Colby Avenue, Everett, WA 98201

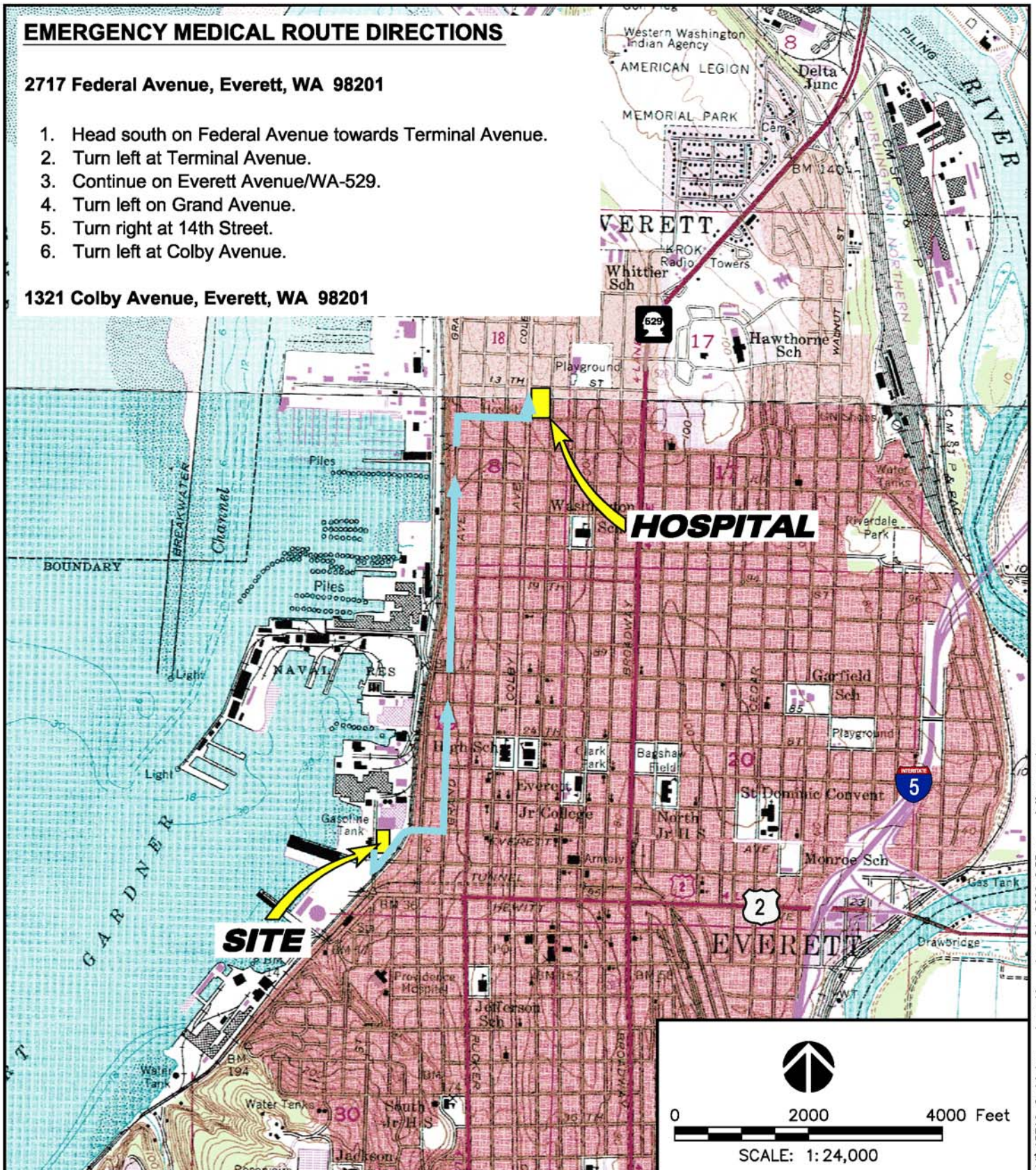

**AMEC Earth & Environmental**

11335 N.E. 122nd Way, Suite 100  
Kirkland, WA, U.S.A. 98034-6918



CLIENT LOGO

CLIENT

**EXXONMOBIL AND  
AMERICAN DISTRIBUTING COMPANY**

PROJECT: EXXONMOBIL/ADC PROPERTY, ECOLOGY SITE ID 2728

DWN BY:

JRS

DATUM:

NAD83

DATE: JUNE 2009

TITLE

**EMERGENCY MEDICAL ROUTE**

CHK'D BY:

AS

REV. NO.:

PROJECT NO:  
9-915-15716-C

PROJECTION:  
WA STATE PLANE

SCALE:  
AS SHOWN

FIGURE No.

## **ATTACHMENT A3**

Street Use Permit Documentation



**APPLICATION for  
PUBLIC WORKS PERMIT**  
PUBLIC WORKS DEPARTMENT  
3200 Cedar Street  
Everett, WA 98201 425 + 257-8810

Date 02/03/2010

Owner Name: City of Everett

Applicant Name: AMEC E&E / Asperausky

Mailing Address: 3200 Cedar St.,  
Everett, WA 98201

Mailing Address: 600 University St.  
Suite 1020, Seattle, WA  
98101

Phone Number: 425-257-8810

Phone Number: (206) 342-1760

Description of Work: Advance 5 soil borings (3 along Everett Ave ROW,  
2 - along Federal Av. ROW) for the City of Everett  
utility upgrade work. See ATTACHED map  
(A drawing or plans may be needed to illustrate work to be done) for boring  
location

Site Address: 2717/2731 Federal Av, Everett, WA

Comments from Inspector during initial inspection:

Approved for issuance by: \_\_\_\_\_ Date: \_\_\_\_\_

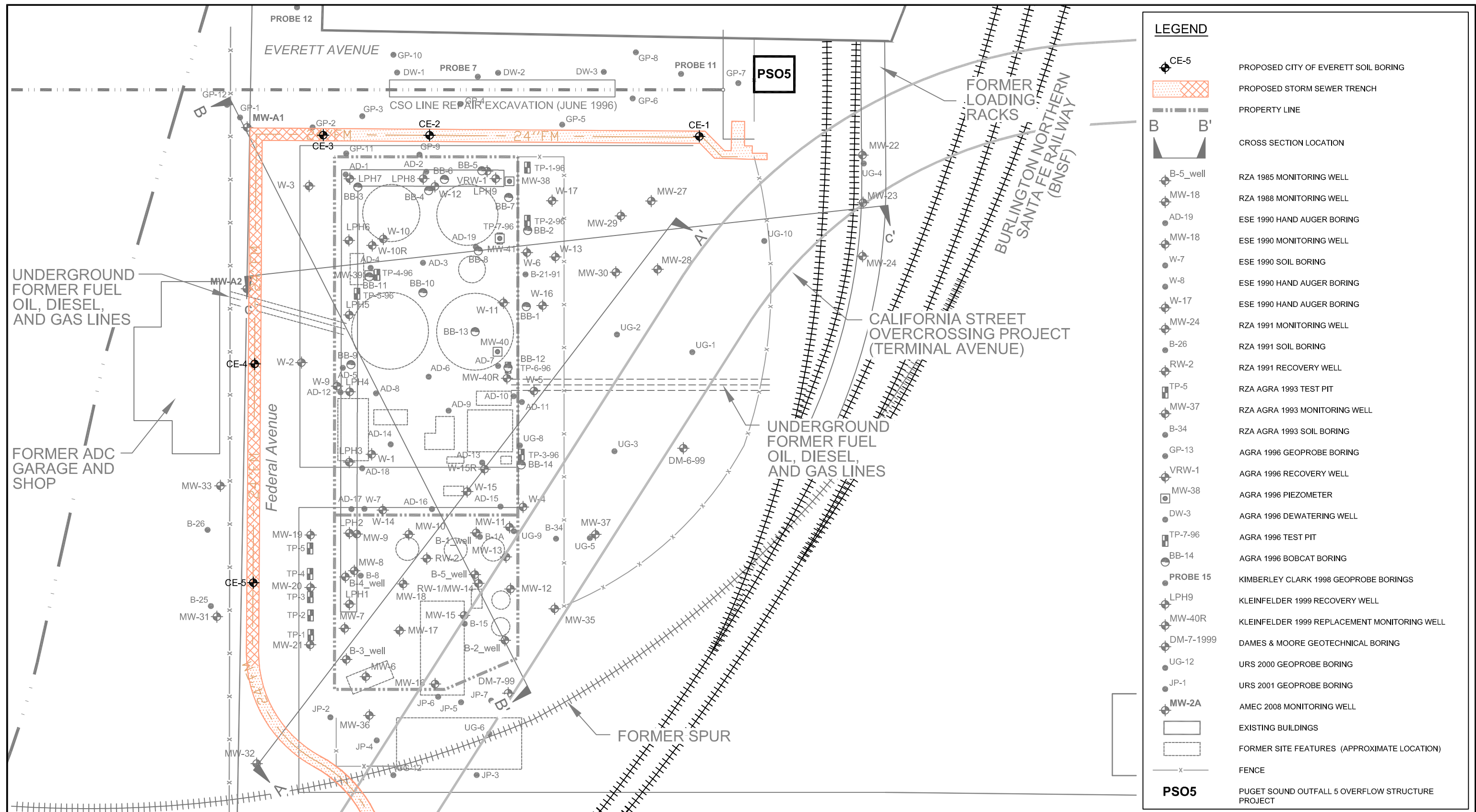

LEGEND	
	PROPOSED CITY OF EVERETT SOIL BORING
	PROPOSED STORM SEWER TRENCH
	PROPERTY LINE
	CROSS SECTION LOCATION
	RZA 1985 MONITORING WELL
	RZA 1988 MONITORING WELL
	ESE 1990 HAND AUGER BORING
	ESE 1990 MONITORING WELL
	ESE 1990 SOIL BORING
	ESE 1990 HAND AUGER BORING
	ESE 1990 HAND AUGER BORING
	RZA 1991 MONITORING WELL
	RZA 1991 SOIL BORING
	RZA 1991 RECOVERY WELL
	RZA AGRA 1993 TEST PIT
	RZA AGRA 1993 MONITORING WELL
	RZA AGRA 1993 SOIL BORING
	AGRA 1996 GEOPROBE BORING
	AGRA 1996 RECOVERY WELL
	AGRA 1996 PIEZOMETER
	AGRA 1996 DEWATERING WELL
	AGRA 1996 TEST PIT
	AGRA 1996 BOBCAT BORING
	KIMBERLEY CLARK 1998 GEOPROBE BORINGS
	KLEINFELDER 1999 RECOVERY WELL
	KLEINFELDER 1999 REPLACEMENT MONITORING WELL
	DAMES & MOORE GEOTECHNICAL BORING
	URS 2000 GEOPROBE BORING
	URS 2001 GEOPROBE BORING
	AMEC 2008 MONITORING WELL
	EXISTING BUILDINGS
	FORMER SITE FEATURES (APPROXIMATE LOCATION)
	FENCE
	PUGET SOUND OUTFALL 5 OVERFLOW STRUCTURE PROJECT

SOURCE: Modified from a map provided by City of Everett, ExxonMobil Oil Corporation and Environmental Resolution, Inc.

CLIENT LOGO

0 60 120  
SCALE IN FEET

CLIENT:

EXXONMOBIL AND AMERICAN DISTRIBUTING COMPANY

AMEC Earth & Environmental  
11810 North Creek Parkway North  
Bothell, WA, U.S.A. 98011-8201

DWN BY:	JRS / BRJ
CHK'D BY:	AS/MS
DATUM:	NONE
PROJECTION:	NONE
SCALE:	1" = 60'

PROJECT	EXXONMOBIL/ADC PROPERTY ECOLOGY SITE ID 2728
TITLE	PROPOSED STORM SEWER UPGRADE SOIL BORINGS

DATE:	FEBRUARY 2010
PROJECT NO:	0-915-15716-D
REV. NO.:	1
FIGURE No.	2

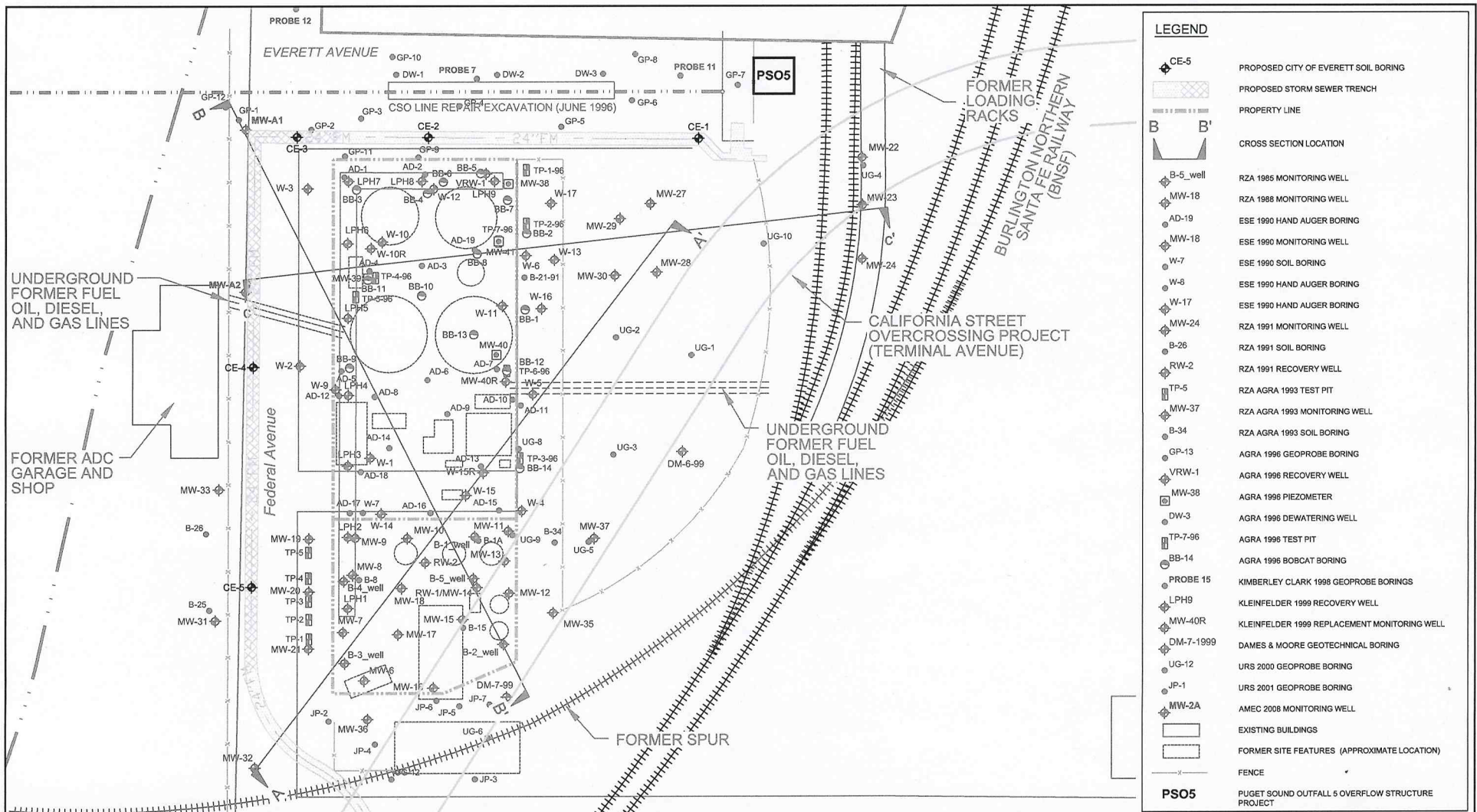

SOURCE: Modified from a map provided by City of Everett, ExxonMobil Oil Corporation and Environmental Resolution, Inc.

0 60 120  
SCALE IN FEET

CLIENT LOGO

CLIENT:

**EXXONMOBIL AND AMERICAN DISTRIBUTING COMPANY**

**AMEC Earth & Environmental**  
11810 North Creek Parkway North  
Bothell, WA, U.S.A. 98011-8201

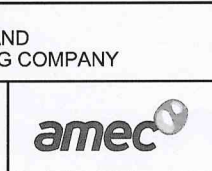

DWN BY: JRS / BRJ  
CHKD BY: AS/MS  
DATUM: NONE  
PROJECTION: NONE  
SCALE: 1" = 60'

PROJECT

**EXXONMOBIL/ADC PROPERTY**  
**ECOLOGY SITE ID 2728**

TITLE

**PROPOSED STORM SEWER UPGRADE**  
**SOIL BORINGS**

DATE: FEBRUARY 2010  
PROJECT NO: 0-915-15716-D  
REV. NO.: 1  
FIGURE No. 2

GENERAL NOTES

1. HUMAN FLAGGER IS REQUIRED TO OPERATE EACH AFAD IN USE. THE HUMAN FLAGGER SHALL BE SAFELY LOCATED OUT OF THE LANE OF TRAFFIC TO COMPLETELY OPERATE THE DEVICE WHILE MAINTAINING VISUAL CONTACT WITH THE TRAFFIC.
2. NIGHTWORK REQUIRES ADDITIONAL ROADWAY LIGHTING AT FLAGGING STATIONS. REFER TO WSDOT STD. SPECIFICATIONS FOR ADDITIONAL DETAILS.
3. RECOMMEND EXTENDING CHANNELIZING DEVICE TAPER ACROSS SHOULDER.
4. PROTECTIVE VEHICLE RECOMMENDED - MAY BE A WORK VEHICLE.
5. SIGN SEQUENCE IS THE SAME FOR BOTH DIRECTIONS OF TRAVEL ON THE ROADWAY.
6. WHEN USED, THE DOWNSTREAM TAPER DEVICE SPACING SHOULD BE 20' O.C.
7. DEVICES ALONG CENTERLINE ARE RECOMMENDED.
8. FOR ADDITIONAL AFAD INFORMATION REFER TO CONTRACT SPECIFICATIONS.
9. AFAD LOCATION SHOWN IS TYPICAL FOR WIDE SHOULDER AREA, ACTUAL LOCATION MAY NEED TO BE IN LANE. PLACEMENT OF AFAD SHALL BE SUCH THAT THE GATE ARM DOES NOT ENCROACH INTO ADJACENT LANE.

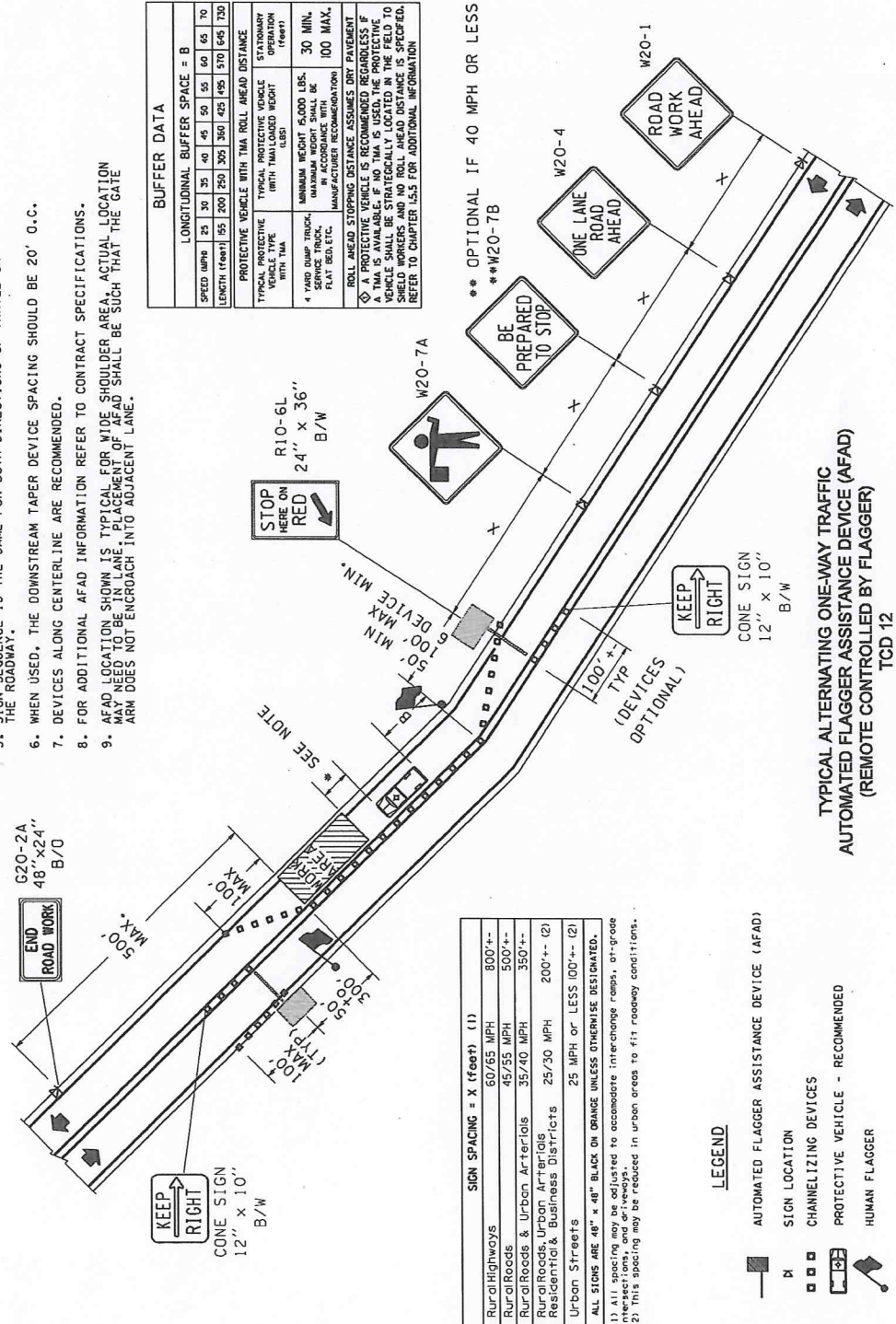

LONGITUDINAL BUFFER SPACE = B	
SPEED MPH	25 30 35 40 45 50 55 60 65 70
LENGTH (feet)	150 200 250 300 350 400 450 500 550 600 645 700

PROTECTIVE VEHICLE WITH TMA	TYPICAL PROTECTIVE VEHICLE WITH TMA	STANDARD SPACING (feet)
4 YARD DUMP TRUCK, FLAT BED, ETC.	MINIMUM WEIGHT 6,000 LBS. MAXIMUM WEIGHT SHALL BE IN ACCORDANCE WITH MANUFACTURER RECOMMENDATION	30 MIN. 100 MAX.

⚠️ A PROTECTIVE VEHICLE IS RECOMMENDED REGARDLESS OF THE TYPE OF PROTECTIVE VEHICLE LOCATED IN THE FIELD TO PROTECT WORKERS AND NO ROLL AHEAD DISTANCE IS SPECIFIED. REFER TO CHAPTER 15.5 FOR ADDITIONAL INFORMATION

ROADWAY TYPE	SIGN SPACING = X (feet)	(1)
Rural/Highways	60/65 MPH	800'+
Rural/Roads	45/55 MPH	500'+
Rural/Roads & Urban Arterials	35/40 MPH	350'+
Rural/Roads, Urban Arterials, Residential & Business Districts	25/30 MPH	200'+ (2)
Urban Streets	25 MPH or LESS	100'+ (2)

ALL SIGNS ARE 48" x 48" BLACK ON ORANGE UNLESS OTHERWISE DESIGNATED.

(1) All spacing may be adjusted to accommodate interchange ramps, off-grade

(2) This spacing may be reduced in urban areas to fit roadway conditions.

LEGEND

- AUTOMATED FLAGGER ASSISTANCE DEVICE (AFAD)
- SIGN LOCATION
- CHANNELIZING DEVICES
- PROTECTIVE VEHICLE - RECOMMENDED
- HUMAN FLAGGER

TYPICAL ALTERNATING ONE-WAY TRAFFIC  
 AUTOMATED FLAGGER ASSISTANCE DEVICE (AFAD)  
 (REMOTE CONTROLLED BY FLAGGER)  
 TCD 12



BUFFER DATA										
LONGITUDINAL BUFFER SPACE = B										
SPEED (MPH)	25	30	35	40	45	50	55	60	65	70
LENGTH (feet)	155	200	250	305	360	425	495	570	645	730
PROTECTIVE VEHICLE WITH TMA ROLL AHEAD DISTANCE										
TYPICAL PROTECTIVE VEHICLE TYPE WITH TMA	TYPICAL PROTECTIVE VEHICLE WITH TMA LOADED WEIGHT (LBS)								STATIONARY OPERATION (Feet)	
4 YARD DUMP TRUCK, SERVICE TRUCK, FLAT BED, ETC.	MINIMUM WEIGHT 15,000 LBS. MAXIMUM WEIGHT SHALL BE IN ACCORDANCE WITH MANUFACTURER RECOMMENDATION								30 MIN. 100 MAX.	
ROLL AHEAD STOPPING DISTANCE ASSUMES DRY PAVEMENT										
A PROTECTIVE VEHICLE IS RECOMMENDED REGARDLESS IF A TMA IS AVAILABLE. IF NO TMA IS USED, THE PROTECTIVE VEHICLE SHALL BE STRATEGICALLY LOCATED IN THE FIELD TO SHIELD WORKERS AND NO ROLL AHEAD DISTANCE IS SPECIFIED. REFER TO CHAPTER 1.5.5 FOR ADDITIONAL INFORMATION										

CHANNELIZING DEVICE SPACING (FEET)		
MPH	TAPER	TANGENT
50 / 65	40	80
35 / 45	30	60
25 / 30	20	40

SIGN SPACING = X (FEET) (1)		
RURAL HIGHWAYS	80 / 65 MPH	800±
RURAL ROADS	45 / 55 MPH	500±
RURAL ROADS & URBAN ARTERIALS	35 / 40 MPH	350±
RURAL ROADS, URBAN ARTERIALS, RESIDENTIAL & BUSINESS DISTRICTS	25 / 30 MPH	200± (2)
URBAN STREETS	25 MPH OR LESS	100± (2)
ALL SIGNS ARE 48" x 48" BLACK ON ORANGE UNLESS OTHERWISE DESIGNATED.		

- (1) All spacing may be adjusted to accommodate interchange ramps, at-grade intersections, and driveways.
- (2) This spacing may be reduced in urban areas to fit roadway conditions.

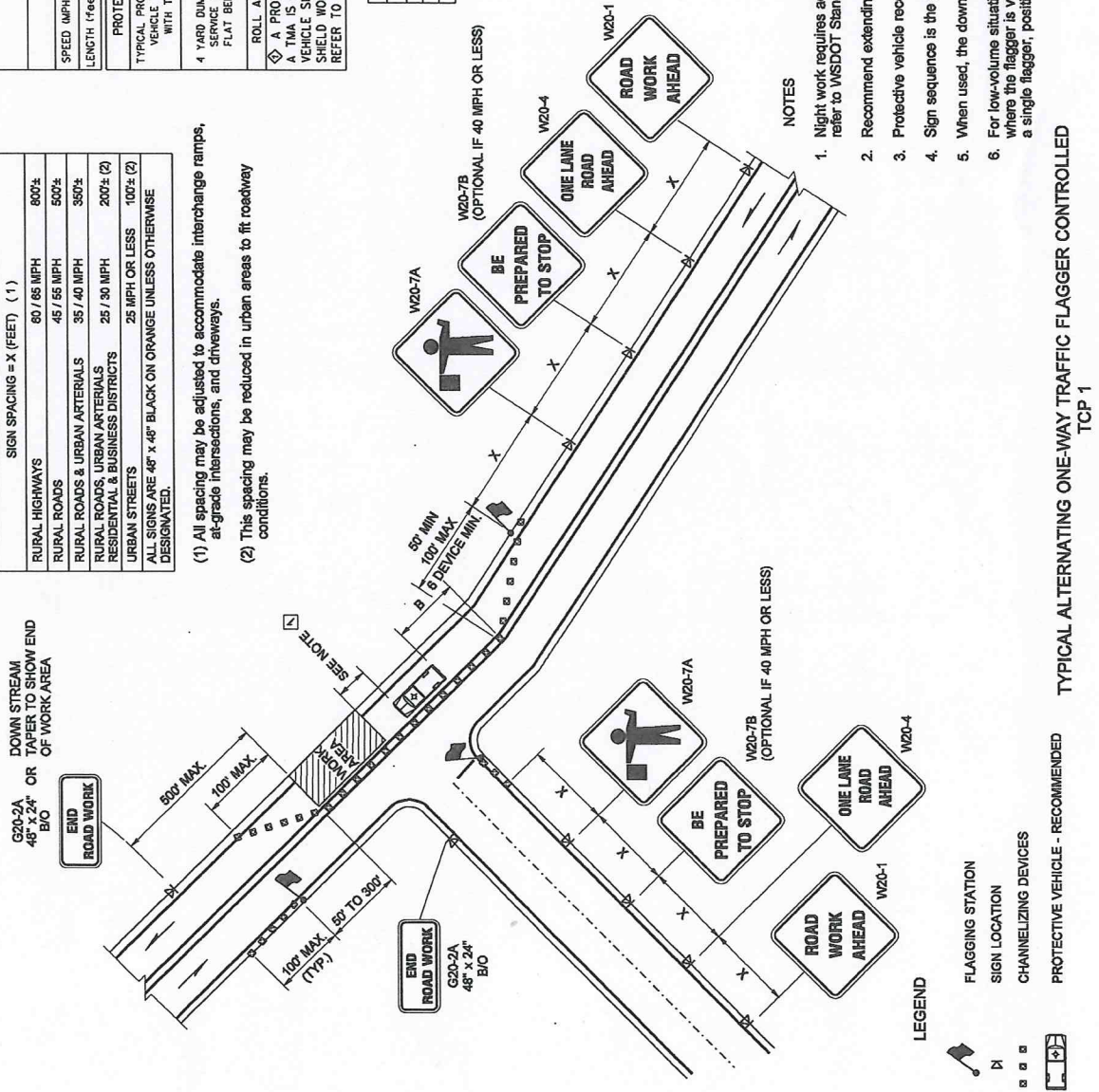

NOTES

- Night work requires additional roadway lighting at flagging stations, refer to WSDOT Standard Specifications for additional details.
- Recommend extending channelizing device taper across shoulder.
- Protective vehicle recommended - may be a work vehicle.
- Sign sequence is the same for both directions of travel on the roadway.
- When used, the downstream taper device spacing should be 20' O.C.
- For low-volume situations with short work zones on straight roadways where the flagger is visible to road users approaching from both directions, a single flagger, positioned to be visible from both directions may be used.

TYPICAL ALTERNATING ONE-WAY TRAFFIC FLAGGER CONTROLLED TCP 1

## **ATTACHMENT A4**

Field Documentation Forms

**AMEC Earth & Environmental, Inc.**11810 North Creek Parkway N  
Bothell, Washington 98011Tel (425) 368-1000  
Fax (425) 368-1001**DAILY FIELD REPORT**

PROJECT NAME <b>Mobil/ADC Everett Facility</b>		PROJECT NO. <b>9915-15716-0</b>	FIELD REPORT NO.
ADDRESS <b>2717/2731 Federal Avenue</b>		DATE	PAGE  OF
CITY OR COUNTY <b>Everett, WA</b>	PERMIT NO.	ARRIVAL TIME	DEPARTURE TIME
CLIENT <b>ExxonMobil</b>	AMEC PROJECT MANAGER/PHONE NO.		
GENERAL CONTRACTOR	AMEC FIELD REPRESENTATIVE/ MOBILE NO.		
SUBCONTRACTOR	WEATHER		
TYPE OF WORK PERFORMED			
EQUIPMENT USED			

**COMMENTS**

--

# SOIL BORING LOG



PROJECT NAME						PROJECT NO.		BORING NO.	
AEE FIELD REPRESENTATIVE						ELEV.	DEPTH	PAGE OF	
SPLIT SPOON DIA.	SAMPLE NUMBER	BLOW COUNT	DEPTH SAMPLED	RECOVERY	GROUNDWATER	DRILLING CONTRACTOR		DATE BEGUN	
						EQUIPMENT USED		WEATHER	
						SAMPLE NUMBER G = GRAB S = SPLIT SPOON T = SHELBY TUBE		DATE COMPLETED	
						SOIL DESCRIPTION			
						DEPTH (FEET)			
						0			
						1			
						2			
						3			
						4			
						5			
						6			
						7			
						8			
						9			
						0			
						1			
						2			
						3			
						4			
						5			
						6			
						7			
						8			
						9			
						0			

COMMENTS





## **APPENDIX F**

Simplified Terrestrial Ecological Evaluation

**Table 749-1**

**Simplified Terrestrial Ecological Evaluation-Exposure Analysis Procedure**

Estimate the area of contiguous (connected) <u>undeveloped land</u> on the site or within 500 feet of any area of the site to the nearest 1/2 acre (1/4 acre if the area is less than 0.5 acre).																						
1) From the table below, find the number of points corresponding to the area and enter this number in the field to the right.																						
	<table border="1"> <thead> <tr> <th>Area (acres)</th> <th>Points</th> </tr> </thead> <tbody> <tr><td>0.25 or less</td><td>4</td></tr> <tr><td>0.5</td><td>5</td></tr> <tr><td>1.0</td><td>6</td></tr> <tr><td>1.5</td><td>7</td></tr> <tr><td>2.0</td><td>8</td></tr> <tr><td>2.5</td><td>9</td></tr> <tr><td>3.0</td><td>10</td></tr> <tr><td>3.5</td><td>11</td></tr> <tr><td>4.0 or more</td><td>12</td></tr> </tbody> </table>	Area (acres)	Points	0.25 or less	4	0.5	5	1.0	6	1.5	7	2.0	8	2.5	9	3.0	10	3.5	11	4.0 or more	12	8
Area (acres)	Points																					
0.25 or less	4																					
0.5	5																					
1.0	6																					
1.5	7																					
2.0	8																					
2.5	9																					
3.0	10																					
3.5	11																					
4.0 or more	12																					
2) Is this an <u>industrial</u> or <u>commercial</u> property? If yes, enter a score of 3. If no, enter a score of 1		3																				
3) <sup>a</sup> Enter a score in the box to the right for the habitat quality of the site, using the following rating system <sup>b</sup> . High=1, Intermediate=2, Low=3		3																				
4) Is the undeveloped land likely to attract wildlife? If yes, enter a score of 1 in the box to the right. If no, enter a score of 2. <sup>c</sup>		2																				
5) Are there any of the following soil contaminants present: Chlorinated dioxins/furans, PCB mixtures, DDT, DDE, DDD, aldrin, chlordane, dieldrin, endosulfan, endrin, heptachlor, benzene hexachloride, toxaphene, hexachlorobenzene, pentachlorophenol, pentachlorobenzene? If yes, enter a score of 1 in the box to the right. If no, enter a score of 4.		4																				
6) Add the numbers in the boxes on lines 2-5 and enter this number in the box to the right. If this number is larger than the number in the box on line 1, the simplified evaluation may be ended.		12																				

**Notes for Table 749-1**

<sup>a</sup> It is expected that this habitat evaluation will be undertaken by an experienced field biologist. If this is not the case, enter a conservative score of (1) for questions 3 and 4.

<sup>b</sup> **Habitat rating system.** Rate the quality of the habitat as high, intermediate or low based on your professional judgment as a field biologist. The following are suggested factors to consider in making this evaluation:

**Low:** Early successional vegetative stands; vegetation predominantly noxious, nonnative, exotic plant species or weeds. Areas severely disturbed by human activity, including intensively cultivated croplands. Areas isolated from other habitat used by wildlife.



**High:** Area is ecologically significant for one or more of the following reasons: Late-[successional](#) native plant communities present; relatively high species diversity; used by an uncommon or rare species; [priority habitat](#) (as defined by the Washington Department of fish and Wildlife); part of a larger area of habitat where size or fragmentation may be important for the retention of some species.

**Intermediate:** Area does not rate as either high or low.

<sup>c</sup> Indicate "yes" if the area attracts wildlife or is likely to do so. Examples: Birds frequently visit the area to feed; evidence of high use b mammals (tracks, scat, etc.); habitat "island" in an industrial area; unusual features of an area that make it important for feeding animals; heavy use during seasonal migrations.

[\[Area Calculation Aid\]](#) [\[Aerial Photo with Area Designations\]](#) [\[TEE Table 749-1\]](#) [\[Index of Tables\]](#)

[\[Exclusions Main\]](#) [\[TEE Definitions\]](#) [\[Simplified or Site-Specific?\]](#) [\[Simplified Ecological Evaluation\]](#) [\[Site-Specific Ecological Evaluation\]](#) [\[WAC 173-340-7493\]](#)

[\[TEE Home\]](#)

## **APPENDIX G**

Schedule



## Appendix G

### **ExxonMobil / ADC Property, Ecology Site ID 2728 Work Schedule 2717/2731 Federal Avenue, Everett, Washington**

The potential liable parties (PLPs) shall perform the actions identified in this work plan and required under the Agreed Order according to the schedule presented below. Days are calendar days; if due dates fall on a weekend or holiday, deliverables will be submitted to Ecology on the next business day. Note, when Ecology provides comments in red-line strikeout format (i.e., comments made directly within the electronic version of the document), the PLPs may respond to those comments directly within the electronic document.

#### **1.0 REMEDIAL INVESTIGATION FIELD WORK**

**FFS Field Work** – Activities associated with the FFS shall be initiated within 15 days of Ecology's execution of the final Agreed Order. Analytical sampling data collected as part of the FFS shall be provided to Ecology within 45 days after receipt of the validated data. The initial analytical data gathered as part of the FFS shall be compiled for Ecology in the form of a technical memo. The technical memo should discuss the field activities and associated analytical results in addition to preliminary cleanup levels, the extent of contamination (plotted on maps), and any data gaps that need to be filled to define the nature and extent of contamination. Note that the preliminary cleanup levels may be different than the screening levels identified in this work plan based on a better understanding of the conceptual site model for the Site (e.g., it may be shown that contaminants in site soil and/or groundwater may not be impacting surface water).

The data and results associated with the tidal study shall be presented in the form of a technical memo to Ecology within 30 days after completion the tidal study field work. The data and results of the tidal study may be included in the technical memo described in the paragraph above, or as a separate document.

Information provided in the technical memo(s) described above will be used to make a determination with regard to whether additional investigation is required to define the full nature and extent of contamination (see next bullet).

**Additional field FFS activities (if needed)** – Additional field FFS activities may be required to adequately delineate the nature and extent of contamination at the Site, and/or to conduct pilot testing of a remedial alternative. The scope, schedule, and submittal requirements for additional field FFS activities shall be developed by the PLPs, and shall be submitted to Ecology for review and concurrence.

**Environmental Data Submittals** – All sampling data (including all historic data) shall be submitted to Ecology in both printed and electronic formats in accordance with Ecology's Toxics Cleanup Program Policy 840 (Data Submittal Requirements) and/or any subsequent procedures specified by Ecology for data submittal. Policy 840 is presented in Exhibit C of this Agreed Order. Historic data, in addition to new data collected as part of the initial or first phase of the FFS, shall be supplied to Ecology in electronic format (i.e., EIM and the PLPs original database format) 45 days after the new data has been validated. Data collected as part of any additional FFS field sampling activities shall also be supplied to Ecology in electronic format (i.e., EIM) 45 days after the data has been validated.

## **2.0 FFS REPORT SUBMITTAL**

**First Draft FFS Report** – The first draft FFS report shall be due to Ecology 120 calendar days after receipt by the PLPs Project Manager of all final analytical data collected during the FFS. The first draft will then undergo a 30-day review period by Ecology.

**Second Draft FFS Report** – The second draft FFS report shall address any comments/suggestions submitted by Ecology. The second draft FFS report shall be due 60 days after Ecology provides its comments. The draft final version will undergo a 20-day review period by Ecology.

**Draft Final FFS Report** – The draft final FFS report shall be due 30 days after receipt of Ecology comments on the second draft FFS report.

**Final FFS Report** – The final FFS report shall be submitted to Ecology 45 days after Ecology's final review and comments. The final FFS will be included in the public comment period conducted for the Cleanup Action Plan (see 3. below)

## **3.0 CLEANUP ACTION PLAN (CAP) SUBMITTAL**

**Draft CAP** – The draft CAP shall be submitted to Ecology 60 days after the draft final FFS Report is finalized and ready for public comment. This draft CAP will then undergo a 30-day review period by Ecology.

**Draft Final CAP** – The draft final CAP shall address comments submitted by Ecology on the draft CAP. This draft final CAP shall be due 60 days after submittal of Ecology comments of the draft CAP. The draft final CAP will undergo a 30-day public comment period under a second Agreed Order or Consent Decree before it becomes a final document. The comment period for the draft final FFS report will be combined with the comment period for the draft CAP/second Agreed Order or Consent Decree.

## **APPENDIX H**

List of applicable or relevant and appropriate requirements

## **Appendix H**

### **Applicable or Relevant and Appropriate Requirements (ARARs)**

The starting point for ARARs is the MTCA cleanup levels and regulations that address implementation of a cleanup under MTCA (Chapter 173.105D RCW; Chapter 173-340 WAC).

Other potential ARARs may include the following:

1. State Water Pollution Control Act (Chapter 90.48 RCW).
2. Applicable surface water quality criteria published in the water quality standards for surface waters of the State of Washington, Chapter 173-201A WAC.
3. Applicable surface water quality criteria published under Section 304 of the Clean Water Act.
4. Applicable surface water quality criteria published under National Toxics Rule (40 C.F.R. Part 131).
5. Washington State Hazardous Waste Management Act (Chapter 70.105 RCW, and State Dangerous Waste Regulation (Chapter 173-303).
6. Solid Waste Management-Reduction and Recycling (Chapter 70.95 RCW).
7. Minimum Standards for Construction and Maintenance of Wells (Chapter 173-160 RCW).
8. Washington Clean Air Act (Chapter 70.94 WAC).
9. Puget Sound Clean Air Agency Regulations (<http://www.pscleanair.org>).
10. Occupational Safety and Health Act (OSHA), 29 CFR Subpart 1910.120.
11. Washington Industrial Safety and Health Act (WISHA).
12. Shoreline Management Act (Chapter 90.58 and Chapter 173-14-28 WAC)
13. Archaeological and Cultural Resources Act (Chapter 43.53 RCW)